

The symplectic properties of the $\mathrm{PGL}(n, \mathbb{C})$ -gluing equations

Stavros Garoufalidis¹ and Christian K. Zickert²

Abstract. In [12] we studied $\mathrm{PGL}(n, \mathbb{C})$ -representations of a 3-manifold via a generalization of Thurston’s gluing equations. Neumann has proved some symplectic properties of Thurston’s gluing equations that play an important role in recent developments of exact and perturbative Chern–Simons theory. In this paper, we prove similar symplectic properties of the $\mathrm{PGL}(n, \mathbb{C})$ -gluing equations for all ideal triangulations of compact oriented 3-manifolds.

Mathematics Subject Classification (2010). 57N10; 57M27.

Keywords. Ideal triangulations, $\mathrm{PGL}(n, \mathbb{C})$ -gluing equations, shape coordinates, symplectic properties, Neumann–Zagier equations.

Contents

1	Introduction	506
2	Preliminaries and statement of results	506
3	Shape assignments and gluing equations	514
4	Definition of the chain complex	517
5	Characterization of $\mathrm{Im}(\beta^*)$	520
6	The outer homology groups	523
7	The middle homology group	533
8	Cusp equations and rank	544
	References	550

¹ S. Garoufalidis was supported by DMS-11-05678.

² C. K. Zickert was supported by DMS-11-45374 and DMS-13-09088.

1. Introduction

Thurston's gluing equations are a system of polynomial equations that were introduced to concretely construct hyperbolic structures. They are defined for every compact, oriented 3-manifold M with arbitrary, possibly empty, boundary together with a topological ideal triangulation \mathcal{T} . The system has the form

$$\prod_j z_j^{A_{ij}} \prod_j (1 - z_j)^{B_{ij}} = \epsilon_i, \quad (1.1)$$

where A and B are integer matrices whose columns are parametrized by the simplices of \mathcal{T} and $\epsilon_i \in \{-1, 1\}$. Each non-degenerate ($z_j \notin \{0, 1, \infty\}$) solution explicitly determines (up to conjugation) a representation of $\pi_1(M)$ in $\mathrm{PGL}(2, \mathbb{C}) = \mathrm{PSL}(2, \mathbb{C})$.

The matrices A and B in (1.1) have some remarkable symplectic properties that play a fundamental role in exact and perturbative Chern–Simons theory for $\mathrm{PSL}(2, \mathbb{C})$, see [9, 4, 6, 8, 11, 13, 5].

In [12] Garoufalidis, Goerner and Zickert generalized Thurston's gluing equations to representations in $\mathrm{PGL}(n, \mathbb{C})$, i.e. they constructed a system of the form (1.1) such that each solution determines a representation of $\pi_1(M)$ in $\mathrm{PGL}(n, \mathbb{C})$. The $\mathrm{PGL}(n, \mathbb{C})$ -gluing equations are expected to play a similar role in $\mathrm{PGL}(n, \mathbb{C})$ -Chern–Simons theory as Thurston's gluing equations play in $\mathrm{PSL}(2, \mathbb{C})$ -Chern–Simons theory.

In this paper we focus on the symplectic properties of the $\mathrm{PGL}(n, \mathbb{C})$ -gluing equations. This was initiated in [12], where we proved that the rows of $(A \mid B)$ are symplectically orthogonal. The symplectic properties for $n = 2$ play a key role in the definition of the formal power series invariants of [8] (conjectured to be asymptotic to all orders to the Kashaev invariant) and in the definition of the 3D-index of Dimofte, Gaiotto, and Gukov [6] whose convergence and topological invariance was established in [11] and [13]. Our results fulfill a wish of the physics literature [5], and may be used for an extension of the work [8, 13, 3] to the setting of the $\mathrm{PGL}(n, \mathbb{C})$ -representations.

2. Preliminaries and statement of results

2.1. Triangulations. Let M denote a compact, connected, oriented 3-manifold with (possibly empty) boundary, and let \hat{M} be the space obtained from M by collapsing each boundary component to a point. In the following, a simplex always refers to a 3-simplex, i.e. a tetrahedron.

Definition 2.1. A triangulation of M is an identification of \widehat{M} with a closed 3-cycle, i.e. a space obtained from a collection of simplices by gluing together pairs of faces via affine homeomorphisms.

We refer to Neumann [17, Section 4] for the precise definition of a closed 3-cycle. In particular, we will make use of the fact that the link of each vertex is connected.

Definition 2.2. A concrete triangulation is a triangulation together with an identification of each simplex of M with a standard ordered 3-simplex. A concrete triangulation is oriented if for each simplex, the orientation induced by the identification with a standard simplex agrees with the orientation of M .

Fix an oriented triangulation \mathcal{T} of M .

Remark 2.3. All of our results can be generalized to arbitrary concrete triangulations (e.g. ordered triangulations) by introducing additional signs. For the sake of notational simplicity, we shall not do this here. The census triangulations are all oriented (when M is orientable).

2.2. Thurston’s gluing equations. We briefly review Thurston’s gluing equations. For details, see Thurston [19] or Neumann and Zagier [18]. Let z_j be complex variables, one for each simplex Δ_j of \mathcal{T} . Assign shape parameters

$$z_j, \quad z'_j = \frac{1}{1 - z_j}, \quad z''_j = 1 - \frac{1}{z_j}$$

to the edges of Δ_j as in Figure 1.

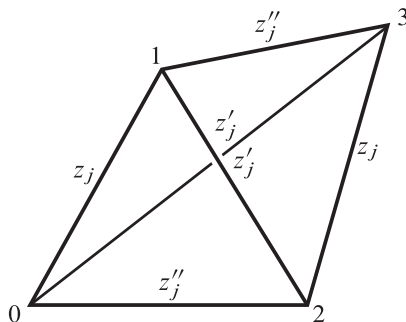

Figure 1. Shape parameters.

2.2.1. Edge equations. We have a gluing equation for each 1-cell e of \mathcal{T} defined by setting equal to 1 the product of all shape parameters assigned to the edges identified with e . The gluing equation for e can thus be written in the form

$$\prod_j (z_j)^{A'_{e,j}} \prod_j (z'_j)^{B'_{e,j}} \prod_j (z''_j)^{C'_{e,j}} = 1 \quad (2.1a)$$

or

$$\prod_j (z_j)^{A_{e,j}} \prod_j (1 - z_j)^{B_{e,j}} = \varepsilon_e, \quad (2.1b)$$

where $A = A' - C'$ and $B = C' - B'$ are the so-called gluing equation matrices. Each non-degenerate ($z_j \in \mathbb{C} \setminus \{0, 1, \infty\}$) solution determines a representation $\pi_1(M) \rightarrow \mathrm{PGL}(2, \mathbb{C})$. Note that the rows of the gluing equation matrices are parametrized by 1-cells, and the columns by the simplices of \mathcal{T} .

2.2.2. Cusp equations. Each (non-degenerate) solution $z = \{z_j\}$ to the edge equations gives rise to a cohomology class $C(z) \in H^1(\partial M; \mathbb{C}^*)$. This is defined by taking a class $\alpha \in H_1(M)$ to the product of the shape parameters of the edges passed by traversing a normal curve in M representing α . One can show that $C(z)$ is trivial if and only if the representation corresponding to z is boundary-unipotent. Fixing a system of generators of $H_1(\partial M)$, the vanishing of $C(z)$ is equivalent to a system of equations

$$\prod_j (z_j)^{A'_{\lambda,j}{}^{\mathrm{cusp}}} \prod_j (z'_j)^{B'_{\lambda,j}{}^{\mathrm{cusp}}} \prod_j (z''_j)^{C'_{\lambda,j}{}^{\mathrm{cusp}}} = 1$$

or

$$\prod_j (z_j)^{A_{\lambda,j}{}^{\mathrm{cusp}}} \prod_j (1 - z_j)^{B_{\lambda,j}{}^{\mathrm{cusp}}} = \varepsilon_\lambda$$

of the form (2.1) with an equation for each generator λ . Note that the rows of the cusp equation matrices are parametrized by generators λ of $H_1(\partial M)$, and the columns by the simplices of \mathcal{T} .

2.3. Neumann's chain complex. For an ordered 3-simplex Δ , let J_Δ denote the free abelian group generated by the *unoriented* edges of Δ subject to the relations

$$\varepsilon_{01} = \varepsilon_{23}, \quad \varepsilon_{12} = \varepsilon_{03}, \quad \varepsilon_{02} = \varepsilon_{13}, \quad (2.3)$$

$$\varepsilon_{01} + \varepsilon_{12} + \varepsilon_{02} = 0. \quad (2.4)$$

Here ε_{ij} denotes the edge between vertices i and j of Δ . Note that (2.3) states that two opposite edges are equal, and that (2.3) and (2.4) together imply that the sum of the edges incident to a vertex is 0.

The space J_Δ is endowed with a non-degenerate skew symmetric bilinear form Ω defined uniquely by

$$\Omega(\varepsilon_{01}, \varepsilon_{12}) = \Omega(\varepsilon_{12}, \varepsilon_{02}) = \Omega(\varepsilon_{02}, \varepsilon_{01}) = 1.$$

The form Ω may be represented by the quiver in Figure 2. Namely, each edge of Δ corresponds to a vertex of the quiver, and $\Omega(\varepsilon, \varepsilon') = 1$ if and only if there is a directed edge in the quiver going from ε to ε' .

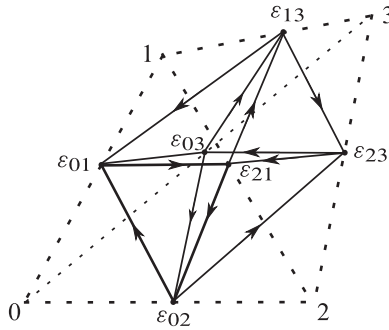

Figure 2. Quiver representation of Ω .

Neumann [17, Theorem 4.1] encoded the symplectic properties of the gluing equations in terms of a chain complex $\mathcal{J} = \mathcal{J}(\mathcal{T})$

$$0 \longrightarrow C_0(\mathcal{T}) \xrightarrow{\alpha} C_1(\mathcal{T}) \xrightarrow{\beta} J(\mathcal{T}) \xrightarrow{\beta^*} C_1(\mathcal{T}) \xrightarrow{\alpha^*} C_0(\mathcal{T}) \longrightarrow 0 \quad (2.5)$$

defined combinatorially from the triangulation \mathcal{T} . Here

- $C_i(\mathcal{T})$ is the free \mathbb{Z} -module of the unoriented i -simplices of \mathcal{T} ;
- $J(\mathcal{T}) = \bigoplus_{\Delta \in \mathcal{T}} J_\Delta$, with Ω extended orthogonally;
- α takes a 0-cell to the sum of incident 1-cells (with multiplicity);
- β takes a 1-cell to the sum of its edges;
- α^* maps an edge to the sum of its endpoints;
- β^* is the unique rotation equivariant map taking ε_{01} to

$$[\varepsilon_{03}] + [\varepsilon_{12}] - [\varepsilon_{02}] - [\varepsilon_{13}];$$

- α^* and β^* are the duals of α and β (using that $J(\mathcal{T}) \cong J(\mathcal{T})^*$ via Ω).

Since $\beta^* \circ \beta = 0$, $\text{Ker}(\beta^*)$ is Ω -orthogonal to $\mathfrak{N}(\beta)$, so Ω descends to a form on $H_3(\mathcal{J})$. This form remains non-degenerate on $H_3(\mathcal{J})$ modulo torsion.

The complex \mathcal{J} is indexed such that \mathcal{J}_5 is the leftmost $C_0(\mathcal{T})$, and \mathcal{J}_0 the rightmost.

Theorem 2.4 (Neumann [17, Theorem 4.2]). *The homology groups of \mathcal{J} are given by*

$$H_5(\mathcal{J}) = 0, \quad H_4(\mathcal{J}) = \mathbb{Z}/2\mathbb{Z}, \quad H_3(\mathcal{J}) = K \oplus H^1(\widehat{M}; \mathbb{Z}/2\mathbb{Z}),$$

$$H_2(\mathcal{J}) = H_1(\widehat{M}; \mathbb{Z}/2\mathbb{Z}), \quad H_1(\mathcal{J}) = \mathbb{Z}/2\mathbb{Z},$$

where $K = \text{Ker}(H_1(\partial M, \mathbb{Z}) \rightarrow H_1(M, \mathbb{Z}/2\mathbb{Z}))$. Moreover, the isomorphism

$$H_3(\mathcal{J})/\text{torsion} \cong K$$

identifies Ω with the intersection form (restricted to K) on $H_1(\partial M)$.

Remark 2.5. Under the isomorphism

$$H_3(\mathcal{J}) \otimes \mathbb{Z}[1/2] \cong H_1(\partial M; \mathbb{Z}[1/2]), \tag{2.6}$$

the form Ω corresponds to *twice* the intersection form [17, Theorem 4.1].

2.4. Symplectic properties of the gluing equations. Neumann’s result implies some important symplectic properties of the gluing equation matrices. We formulate them here in a way that generalizes to the $\text{PGL}(n, \mathbb{C})$ setting.

By the definition of β we have for each 1-cell e

$$\begin{aligned} \beta(e) &= \sum_j A'_{e,j} \varepsilon_{01,j} + \sum_j B'_{e,j} \varepsilon_{12,j} + \sum_j C'_{e,j} \varepsilon_{02,j} \\ &= \sum_j A_{e,j} \varepsilon_{01,j} + \sum_j B_{e,j} \varepsilon_{12,j} \in J(\mathcal{T}). \end{aligned} \tag{2.7}$$

Similarly, for a generator λ of $H_1(\partial M)$, we have the element

$$\delta(\lambda) = \sum_j A_{\lambda,j}^{\text{cusp}} \varepsilon_{01,j} + \sum_j B_{\lambda,j}^{\text{cusp}} \varepsilon_{12,j} \in J(\mathcal{T}). \tag{2.8}$$

Neumann shows that this element is in $\text{Ker}(\beta^*)$, so that we have a map

$$\delta: H_1(\partial M) \longrightarrow H_3(\mathcal{J}).$$

Corollary 2.6. *Let w_J be the standard symplectic form on \mathbb{Z}^{2t} given by $J = \begin{pmatrix} 0 & I \\ -I & 0 \end{pmatrix}$, where t is the number of simplices of \mathcal{T} and let ι denote the intersection form on $H_1(\partial M)$.*

- (i) *For any rows x and y of $(A \mid B)$, $w_J(x, y) = 0$.*
- (ii) *For any rows x of $(A \mid B)$ and y of $(A^{\mathrm{cusp}} \mid B^{\mathrm{cusp}})$, $w_J(x, y) = 0$.*
- (iii) *For any rows x and y of $(A^{\mathrm{cusp}} \mid B^{\mathrm{cusp}})$ corresponding to λ and μ in $H_1(\partial M)$, respectively, $w_J(x, y) = \Omega(\delta(\lambda), \delta(\mu)) = 2\iota(\lambda, \mu)$.*

Proof. The first and second statement follow from the fact that $\beta^* \circ \beta = 0$, which implies that $\mathrm{Ker}(\beta^*)$ is symplectically orthogonal to $\mathrm{Im}(\beta)$. The third result is proved in Neumann [17], c.f. Remark 2.5. Namely $\delta: H_1(\partial M) \rightarrow H_3(\mathcal{J})$ induces the isomorphism in (2.6). □

Corollary 2.7. *The rank of $(A \mid B)$ is the number of edges minus the number of cusps.*

Proof. It follows from (2.7), that the matrix representation for β in the basis $\{\varepsilon_{01,j}, \varepsilon_{12,j}\}$ for $J(\mathcal{T})$ is the transpose of $(A \mid B)$. The result now follows from the fact that $H_4(\mathcal{J})$ is zero modulo torsion. □

Remark 2.8. A simple argument that uses the Euler characteristic shows that the number of edges of \mathcal{T} equals $t + c - h$, where t is the number of simplices, $h = \frac{1}{2} \mathrm{rank}(H_1(\partial M))$ and c is the number of boundary components. Hence, the matrix $(A \mid B)$ has size $(t + c - h) \times 2t$. In particular, if all boundary components are tori (the case of most interest), the size is $t \times 2t$. If we extend a basis for the row span of $(A \mid B)$ by rows of $(A^{\mathrm{cusp}} \mid B^{\mathrm{cusp}})$, the resulting $t \times 2t$ matrix has full rank, and is thus the upper half of a symplectic matrix. Such matrices play a crucial role in [4, 8, 7, 6, 13].

2.5. Statement of results. The $\mathrm{PGL}(n, \mathbb{C})$ -gluing equations [12] are defined in terms of complex variables $z_{s,\Delta}$, one for each subsimplex s (Definition 3.1) of each simplex Δ of \mathcal{T} . There is a gluing equation for each non-vertex integral point p of \mathcal{T} (Definition 3.3), which can be written in the form

$$\prod_{(s,\Delta)} (z_{s,\Delta})^{A_{p,(s,\Delta)}} \prod_{(s,\Delta)} (1 - z_{s,\Delta})^{B_{p,(s,\Delta)}} = \varepsilon_p,$$

where A and B are integer matrices whose rows are parametrized by the (non-vertex) integral points of \mathcal{T} and columns by the set of subsimplices of the simplices of \mathcal{T} .

Furthermore there is a cusp equation for each generator $\lambda \otimes e_r$ of $H_1(\partial M; \mathbb{Z}^{n-1})$ of the form

$$\prod_{(s,\Delta)} (z_{s,\Delta})^{A_{\lambda \otimes e_r, (s,\Delta)}^{\text{cusp}}} \prod_{(s,\Delta)} (1 - z_{s,\Delta})^{B_{\lambda \otimes e_r, (s,\Delta)}^{\text{cusp}}} = \varepsilon_{\lambda \otimes e_r}$$

for matrices A^{cusp} and B^{cusp} whose rows are parametrized by generators $\lambda \otimes e_r$ of $H_1(\partial M; \mathbb{Z}^{n-1})$ and columns by the set of subsimplices of the simplices of \mathcal{T} .

In Section 4 below we define a chain complex $\mathcal{J}^{\mathfrak{g}} = \mathcal{J}^{\mathfrak{g}}(\mathcal{T})$ (indexed so that $\mathcal{J}_5^{\mathfrak{g}}$ is the leftmost $C_0^{\mathfrak{g}}(\mathcal{T})$)

$$0 \longrightarrow C_0^{\mathfrak{g}}(\mathcal{T}) \xrightarrow{\alpha} C_1^{\mathfrak{g}}(\mathcal{T}) \xrightarrow{\beta} J^{\mathfrak{g}}(\mathcal{T}) \xrightarrow{\beta^*} C_1^{\mathfrak{g}}(\mathcal{T}) \xrightarrow{\alpha^*} C_0^{\mathfrak{g}}(\mathcal{T}) \longrightarrow 0 \quad (2.9)$$

generalizing (2.5). Here \mathfrak{g} denotes the Lie algebra of $\text{SL}(n, \mathbb{C})$, the notation being in anticipation of a generalization to arbitrary simple, complex Lie algebras. The three middle terms of $\mathcal{J}^{\mathfrak{g}}$ appeared already in Garoufalidis, Goerner, and Zickert [12]. There is a non-degenerate antisymmetric form on $J^{\mathfrak{g}}(\mathcal{T})$ descending to a non-degenerate form on $H_3(\mathcal{J}^{\mathfrak{g}})$ modulo torsion.

Theorem 2.9. *Let $h = \frac{1}{2} \text{rank}(H_1(\partial M))$. The homology groups of $\mathcal{J}^{\mathfrak{g}}$ are given by*

$$H_5(\mathcal{J}^{\mathfrak{g}}) = 0, \quad H_4(\mathcal{J}^{\mathfrak{g}}) = \mathbb{Z}/n\mathbb{Z}, \quad H_3(\mathcal{J}^{\mathfrak{g}}) = K \oplus H^1(\widehat{M}; \mathbb{Z}/n\mathbb{Z}),$$

$$H_2(\mathcal{J}^{\mathfrak{g}}) = H_1(\widehat{M}; \mathbb{Z}/n\mathbb{Z}), \quad H_1(\mathcal{J}^{\mathfrak{g}}) = \mathbb{Z}/n\mathbb{Z},$$

where $K \subset H_1(\partial M, \mathbb{Z}^{n-1})$ is a subgroup of index n^h . Moreover, the isomorphism

$$H_3(\mathcal{J}^{\mathfrak{g}}) \otimes \mathbb{Z}[1/n] \cong H_1(\partial M; \mathbb{Z}[1/n]^{n-1}) \quad (2.10)$$

identifies Ω with the non-degenerate form $\omega_{A_{\mathfrak{g}}}$ on $H_1(\partial M; \mathbb{Z}[1/n]^{n-1})$ given by

$$\omega_{A_{\mathfrak{g}}}(\lambda \otimes v, \mu \otimes w) = \iota(\lambda, \mu) \langle v, A_{\mathfrak{g}} w \rangle, \quad (2.11)$$

where ι is the intersection form on $H_1(\partial M)$, $\langle \cdot, \cdot \rangle$ the canonical inner product on \mathbb{R}^n , and $A_{\mathfrak{g}}$ the Cartan matrix of \mathfrak{g} .

Remark 2.10. Presumably, $K = \text{Ker}(H_1(\partial M; \mathbb{Z}^{n-1}) \rightarrow H_1(M; \mathbb{Z}/n\mathbb{Z}))$, where $\mathbb{Z}/n\mathbb{Z}$ is regarded as the quotient of \mathbb{Z}^{n-1} by the column space of the Cartan matrix. This would be a natural generalization of the K in Theorem 2.4.

As explained in Section 4.1, the group $J^{\mathfrak{g}}(\mathcal{T})$ is generated by terms $(s, e)_{\Delta}$, where e is an edge of a subsimplex s of a simplex Δ of \mathcal{T} . As in (2.7) we have

$$\beta(p) = \sum_{(s, \Delta)} A_{p, (s, \Delta)}(s, \varepsilon_{01})_{\Delta} + \sum_{(s, \Delta)} B_{p, (s, \Delta)}(s, \varepsilon_{12})_{\Delta} \in J^{\mathfrak{g}}(\mathcal{T}).$$

Also, as in (2.8), we have for each generator $\lambda \otimes e_r$ of $H_1(\partial M; \mathbb{Z}^{n-1})$ an element

$$\sum_{(s, \Delta)} A_{\lambda \otimes e_r, (s, \Delta)}^{\mathrm{cusp}}(s, \varepsilon_{01})_{\Delta} + \sum_{(s, \Delta)} B_{\lambda \otimes e_r, (s, \Delta)}^{\mathrm{cusp}}(s, \varepsilon_{12})_{\Delta} \in J^{\mathfrak{g}}(\mathcal{T}),$$

in the kernel of β^* . In fact it equals $\delta'(\lambda \otimes e_r)$ for a map

$$\delta': H_1(\partial M; \mathbb{Z}^{n-1}) \longrightarrow H_3(\mathcal{J}^{\mathfrak{g}}),$$

which induces the isomorphism (2.10) (see Section 8.2). The following is the analogue of Corollary 2.6.

Corollary 2.11. *The rows of $(A \mid B)$ are orthogonal to the rows of $(A^{\mathrm{cusp}} \mid B^{\mathrm{cusp}})$ with respect to the standard symplectic form ω_J . Moreover, if x and y are rows of $(A^{\mathrm{cusp}} \mid B^{\mathrm{cusp}})$ corresponding to $\lambda \otimes e_r$ and $\mu \otimes e_s$, respectively, we have*

$$\omega_J(x, y) = \Omega(\delta'(\lambda \otimes e_r), \delta'(\mu \otimes e_s)) = \iota(\lambda, \mu)\langle e_r, A_{\mathfrak{g}}e_s \rangle.$$

The proof of the following result is identical to that of Corollary 2.7. In the case where all boundary components are tori, the number of non-vertex integral points is $\binom{n+1}{3}$ times the number of simplices (see Lemma 3.5).

Corollary 2.12. *The rank of $(A \mid B)$ is the number of non-vertex integral points minus $c(n - 1)$, where c is the number of boundary components.*

Remark 2.13. If all boundary components are tori, $(A \mid B)$ has twice as many columns as rows, and $c(n - 1) = \frac{1}{2} \mathrm{rank} H_1(\partial M; \mathbb{Z}^{n-1})$. It follows that one can extend a basis for the row space of $(A \mid B)$ by adding rows of $(A^{\mathrm{cusp}} \mid B^{\mathrm{cusp}})$ to obtain a matrix with full rank. This matrix is then the upper part of a symplectic matrix and as stated in the introduction plays a crucial role in extending the work of [4, 8, 7, 6, 13] to the $\mathrm{PGL}(n, \mathbb{C})$ setting.

Remark 2.14. The computation of the rational homology of $H_3(\mathcal{J}^{\mathfrak{g}})$ was obtained for $n = 3$ by Bergeron, Falbel, and Guilloux [2] (using a different, but isomorphic chain complex). A generalization to $n > 3$ by Guilloux [15] yields results similar to ours.

2.6. A side comment on quivers. If you take a quiver as in Figure 2 for each subsimplex and superimpose them canceling edges with opposite orientations, you get the quiver shown in Figure 3. Everything cancels in the interior. The quiver on the face equals the quiver in Fock and Goncharov [10, Figure 1.5], and also appears for $n = 3$ in Bergeron, Falbel, and Guilloux [2, Figure 4]. One can go from the quiver on two of the faces to the quiver on the two other faces by performing quiver mutations (see e.g. Keller [16]). The quiver mutations change the X -coordinates and Ptolemy coordinates by cluster mutations [1], and there is a one-one correspondence between quiver mutations and subsimplices. Although we do not need any of this here, this observation was a major motivation for [14] and [12].

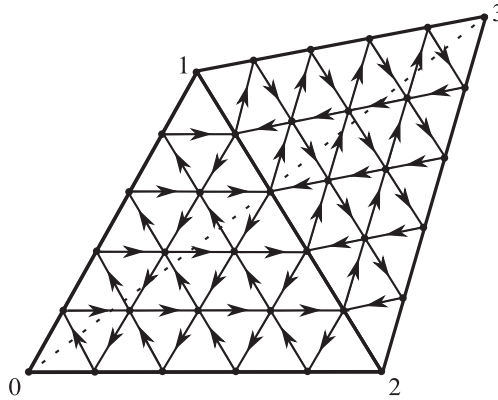

Figure 3. Superposition of copies of the quiver in Figure 2, one for each subsimplex.

3. Shape assignments and gluing equations

We identify each simplex of M with the simplex

$$\Delta_n^3 = \{(x_0, x_1, x_2, x_3) \in \mathbb{R}^4 : 0 \leq x_i \leq n, x_0 + x_1 + x_2 + x_3 = n\}.$$

Let $\Delta_n^3(\mathbb{Z})$ denote the integral points of Δ_n^3 , and $\dot{\Delta}_n^3(\mathbb{Z})$ denote the integral points with the 4 vertex points removed. The natural left A_4 -action on Δ_n^3 given by

$$\sigma(x_0, \dots, x_3) = (x_{\sigma^{-1}(0)}, \dots, x_{\sigma^{-1}(3)})$$

induces A_4 -actions on $\Delta_n^3(\mathbb{Z})$ and $\dot{\Delta}_n^3(\mathbb{Z})$ as well.

Definition 3.1. A *subsimplex* of Δ_n^3 is a subset S of Δ_n^3 obtained by translating $\Delta_2^3 \subset \mathbb{R}^4$ by an element s in $\Delta_{n-2}^3(\mathbb{Z}) \subset \mathbb{Z}^4$, i.e. $S = s + \Delta_2^3$. Note that $|\Delta_n^3(\mathbb{Z})| = \binom{n+1}{3}$.

We shall identify the edges of an ordered simplex with $\dot{\Delta}_2^3(\mathbb{Z})$, e.g. the edges ε_{01} and ε_{12} correspond to (1100) and (0110).

Definition 3.2. A shape assignment on Δ_n^3 is an assignment

$$z: \Delta_{n-2}^3(\mathbb{Z}) \times \dot{\Delta}_2^3(\mathbb{Z}) \longrightarrow \mathbb{C} \setminus \{0, 1\}, \quad (s, e) \longmapsto z_s^e$$

satisfying the *shape parameter relations*

$$\begin{aligned} z_s^{\varepsilon_{01}} &= z_s^{\varepsilon_{23}} = \frac{1}{1 - z_s^{\varepsilon_{02}}}, \\ z_s^{\varepsilon_{12}} &= z_s^{\varepsilon_{03}} = \frac{1}{1 - z_s^{\varepsilon_{01}}}, \\ z_s^{\varepsilon_{02}} &= z_s^{\varepsilon_{13}} = \frac{1}{1 - z_s^{\varepsilon_{12}}}. \end{aligned}$$

One may think of a shape assignment as an assignment of shape parameters to the edges of each subsimplex. The ad hoc indexing of the shape parameters by z , z' and z'' is replaced by an indexing scheme, in which a shape parameter $z_{s,\Delta}^e$ is indexed according to the edge e of the subsimplex s of the simplex Δ to which it is assigned.

Definition 3.3. An *integral point* of \mathcal{T} is an equivalence class of points in $\Delta_n^3(\mathbb{Z})$ identified by the face pairings of \mathcal{T} . We view an integral point as a set of pairs (t, Δ) with $t \in \Delta_n^3(\mathbb{Z})$ and $\Delta \in \mathcal{T}$. An integral point is either a *vertex point*, an *edge point*, a *face point*, or an *interior point*.

Definition 3.4. A shape assignment on \mathcal{T} is a shape assignment $z_{s,\Delta}^e$ on each simplex $\Delta \in \mathcal{T}$ such that for each non-vertex integral point p , the *generalized gluing equation*

$$\prod_{(t,\Delta) \in p} \prod_{s+e=t} z_{s,\Delta}^e = 1. \tag{3.1}$$

is satisfied. Here, the first product is over pairs (t, Δ) representing p , and the second is over pairs $(s, e) \in \Delta_{n-2}^3(\mathbb{Z}) \times \dot{\Delta}_2^3(\mathbb{Z})$ such that $s + e = t$.

The gluing equation for p sets equal to 1 the product of the shape parameters of all edges of subsimplices having p as midpoint, see Figures 4 and 5 (taken from [12]). The product has 6 terms if p is an interior point or a face point, and ν terms if p is an edge point on an edge of valence ν .

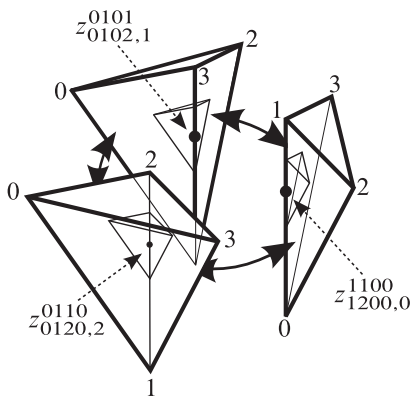

Figure 4. Edge equation for $n = 5$: $z_{1200,0}^{1100} z_{0102,1}^{0101} z_{0120,2}^{0110} = 1$.

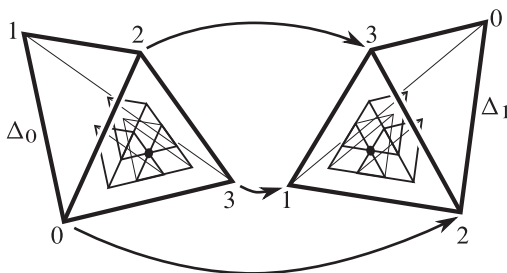

Figure 5. Face equation for $n = 6$: $z_{2011,0}^{0011} z_{1021,0}^{1001} z_{1012,0}^{1010} z_{0211,1}^{0011} z_{0121,1}^{0101} z_{0112,1}^{0110} = 1$.

Lemma 3.5. *If all boundary components are tori, the number of non-vertex integral points is $\binom{n+1}{3}\tau$, where τ is the number of simplices of \mathcal{T} . Hence, the number of variables is the same as the number of equations.*

Proof. Letting ϵ , and ψ denote the number edges, and faces, respectively, the number q of non-vertex integral points is given by

$$q = (n - 1)\epsilon + \frac{(n - 1)(n - 2)}{2}\psi + \frac{(n - 1)(n - 2)(n - 3)}{6}\tau.$$

Clearly, $\psi = 2\tau$, and if all boundary components are tori, a simple Euler characteristic argument shows that $\tau = \epsilon$. It thus follows that $q = \binom{n+1}{3}\tau$, as desired. \square

Note that the gluing equation for p can be written in the form

$$\prod_{(s,\Delta)} (z_{(s,\Delta)})^{A_{p,(s,\Delta)}} \prod_{(s,\Delta)} (1 - z_{(s,\Delta)})^{B_{p,(s,\Delta)}} = \varepsilon_p.$$

Theorem 3.6 (Garoufalidis, Goerner, and Zickert [12]). *A shape assignment on \mathcal{T} determines (up to conjugation) a representation $\pi_1(M) \rightarrow \mathrm{PGL}(n, \mathbb{C})$.*

3.1. X-coordinates. The X -coordinates are defined on the face points of \mathcal{T} , and are used in Section 8 to define the cusp equations. They agree with the X -coordinates of Fock and Goncharov [10].

Definition 3.7. Let z be a shape assignment on Δ_n^3 and let $t \in \Delta_n^3(\mathbb{Z})$ be a face point. The X -coordinate at t is given by

$$X_t = - \prod_{s+e=t} z_s^e,$$

i.e. it equals (minus) the product of the shape parameters of the 3 edges of subsimplices having t as a midpoint.

Remark 3.8. Note that the gluing equation for a face point $p = \{(t_1, \Delta_1), (t_2, \Delta_2)\}$ states that $X_{t_1} X_{t_2} = 1$.

4. Definition of the chain complex

We now define the chain complex (2.9).

4.1. Definition of the terms. Let $C_0^{\mathfrak{g}}(\mathcal{T}) = C_0(\mathcal{T}) \otimes \mathbb{Z}^{n-1}$ and let $C_1^{\mathfrak{g}}(\mathcal{T})$ be the free abelian group on the non-vertex integral points of \mathcal{T} . Letting e_1, \dots, e_{n-1} , denote the standard basis vectors of \mathbb{Z}^{n-1} , it follows that $C_0^{\mathfrak{g}}(\mathcal{T})$ is generated by symbols $x \otimes e_i$, where x is a 0-cell of \mathcal{T} . It will occasionally be convenient to define $e_0 = e_n = 0$. Let

$$J^{\mathfrak{g}}(\mathcal{T}) = \bigoplus_{\Delta \in \mathcal{T}} \bigoplus_{s \in \Delta_{n-2}^3(\mathbb{Z})} J_{\Delta_2^3}$$

be a direct sum of copies of $J_{\Delta_2^3}$, one for each subsimplex of each simplex of \mathcal{T} . The group $J^{\mathfrak{g}}(\mathcal{T})$ is thus generated by the set of all edges e of all subsimplices s

of the simplices Δ of \mathcal{T} , and we denote a generator by $(s, e)_\Delta$. The generators are subject to relations

$$(s, \varepsilon_{01})_\Delta = (s, \varepsilon_{23})_\Delta, \quad (s, \varepsilon_{12})_\Delta = (s, \varepsilon_{03})_\Delta, \quad (s, \varepsilon_{02})_\Delta = (s, \varepsilon_{13})_\Delta, \quad (4.1)$$

$$(s, \varepsilon_{01})_\Delta + (s, \varepsilon_{12})_\Delta + (s, \varepsilon_{02})_\Delta = 0. \quad (4.2)$$

It thus follows that $\{(s, \varepsilon_{01})_\Delta, (s, \varepsilon_{12})_\Delta\}$ is a basis for $J^{\mathfrak{g}}(\mathcal{T})$.

The form Ω on $J_{\Delta_2^3}$ induces by orthogonal extension a form on $J^{\mathfrak{g}}(\mathcal{T})$ also denoted by Ω . Since Ω is non-degenerate it induces a natural identification of $J^{\mathfrak{g}}(\mathcal{T})$ with its dual. Similarly, the natural bases of $C_0^{\mathfrak{g}}(\mathcal{T})$ and $C_1^{\mathfrak{g}}(\mathcal{T})$ induce natural identifications with their respective duals.

4.2. Formulas for β and β^* . Define

$$\beta: C_1^{\mathfrak{g}}(\mathcal{T}) \longrightarrow J^{\mathfrak{g}}(\mathcal{T}), \quad p = \{(t, \Delta)\} \longmapsto \sum_{(\Delta, t) \in p} \sum_{e+s=t} (s, e)_\Delta. \quad (4.3)$$

Hence, β takes p to the formal sum of all the edges of subsimplices whose midpoint is p . By [12, Lemma 7.3], the dual map $\beta^*: J^{\mathfrak{g}}(\mathcal{T}) \rightarrow C_1^{\mathfrak{g}}(\mathcal{T})$ is the unique map satisfying

$$\beta^*((s, \varepsilon_{01})_\Delta) = [(s + \varepsilon_{03}, \Delta)] + [(s + \varepsilon_{12}, \Delta)] - [(s + \varepsilon_{02}, \Delta)] - [(s + \varepsilon_{13}, \Delta)], \quad (4.4a)$$

$$\beta^*((s, \varepsilon_{12})_\Delta) = [(s + \varepsilon_{02}, \Delta)] + [(s + \varepsilon_{13}, \Delta)] - [(s + \varepsilon_{01}, \Delta)] - [(s + \varepsilon_{23}, \Delta)], \quad (4.4b)$$

$$\beta^*((s, \varepsilon_{02})_\Delta) = [(s + \varepsilon_{01}, \Delta)] + [(s + \varepsilon_{23}, \Delta)] - [(s + \varepsilon_{23}, \Delta)] - [(s + \varepsilon_{12}, \Delta)]. \quad (4.4c)$$

We refer to an element of the form $\beta^*((s, \varepsilon_{ij})_\Delta)$ as an *elementary quad relation*, see Figures 6, 7, and 8.

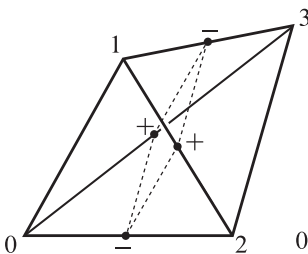

Figure 6. $\beta^*(s, \varepsilon_{01})$.

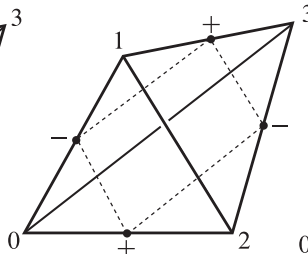

Figure 7. $\beta^*(s, \varepsilon_{12})$.

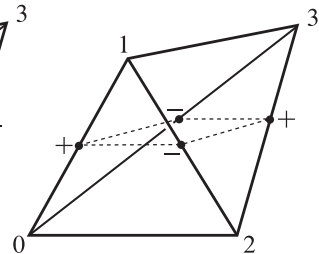

Figure 8. $\beta^*(s, \varepsilon_{02})$.

Lemma 4.1 (Garoufalidis, Goerner, and Zickert [12, Proposition 7.4]). $\beta^* \circ \beta = 0$.

4.3. Formulas for α and α^* . For a 0-cell x of \mathcal{T} and a simplex Δ , let $I_\Delta(x) \subset \{0, 1, 2, 3\}$ be the set of vertices of Δ that are identified with x . Also, for $t \in \Delta_n^3(\mathbb{Z})$ and $k \in \{1, \dots, n - 1\}$, let

$$c_{t,\Delta,k}(x) = |\{i \in I_\Delta(x) : t_i = k\}|.$$

Note that if (t, Δ) and (t', Δ') define the same integral point, then

$$c_{t,\Delta,k}(x) = c_{t',\Delta',k}(x).$$

Define

$$\alpha: C_0^{\mathfrak{g}}(\mathcal{T}) \longrightarrow C_1^{\mathfrak{g}}(\mathcal{T}), \quad x \otimes e_k \longmapsto \sum_p c_{t,\Delta,k}(x) p,$$

where the sum is over all integral points p , and (t, Δ) is any representative of p . Also, define

$$\alpha^*: C_1^{\mathfrak{g}}(\mathcal{T}) \longrightarrow C_0^{\mathfrak{g}}(\mathcal{T}), \quad [(t, \Delta)] \longmapsto \sum_{i=0}^3 x_i \otimes e_{t_i},$$

where x_i is the 0-cell of \mathcal{T} defined by the i th vertex of Δ (recall that $e_0 = 0$). Informally, α takes $x \otimes e_k$ to the integral points at distance k from x (counted with multiplicity), and α^* sends an integral point to its coordinates with respect to any simplex containing it (see Figures 9 and 10). It is elementary to check that α^* is well defined, and that it is the dual of α .

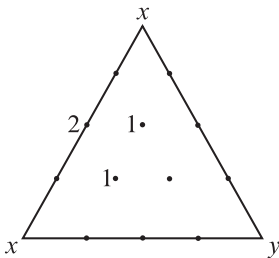

Figure 9. $\alpha(x \otimes e_2)$ for $n = 4$.

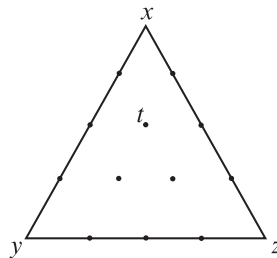

Figure 10. $\alpha^*([t, \Delta]) = x \otimes e_2 + y \otimes e_1 + z \otimes e_1$.

Lemma 4.2. *We have $\alpha^* \circ \beta^* = 0$.*

Proof. Let $s \in \Delta_{n-2}^3(\mathbb{Z})$ be a subsimplex. We have

$$\begin{aligned} \alpha^* \circ \beta^*(s, \varepsilon_{01})_\Delta &= \alpha^*([(s + \varepsilon_{03}, \Delta)]) + \alpha^*([(s + \varepsilon_{12}, \Delta)]) \\ &\quad - \alpha^*([(s + \varepsilon_{02}, \Delta)]) - \alpha^*([(s + \varepsilon_{13}, \Delta)]) \\ &= x_0 \otimes e_{s_0+1} + x_1 \otimes e_{s_1} + x_2 \otimes e_{s_2} + x_3 \otimes e_{s_3+1} \\ &\quad + x_0 \otimes e_{s_1} + x_1 \otimes e_{s_1+1} + x_2 \otimes e_{s_2+1} + x_3 \otimes e_{s_3} \\ &\quad - x_0 \otimes e_{s_0+1} - x_1 \otimes e_{s_1} - x_2 \otimes e_{s_2+1} - x_3 \otimes e_{s_3} \\ &\quad - x_0 \otimes e_{s_0} - x_1 \otimes e_{s_1+1} - x_2 \otimes e_{s_2} - x_3 \otimes e_{s_3+1} \\ &= 0. \end{aligned}$$

Similarly, $\alpha^* \circ \beta^*(s, \varepsilon_{12})_\Delta = \alpha^* \circ \beta^*(s, \varepsilon_{02})_\Delta = 0$. \square

By duality, $\beta \circ \alpha$ is also 0, so by Lemmas 4.1 and 4.2 we have a chain complex $\mathcal{J}^{\mathfrak{g}}(\mathcal{T})$:

$$0 \longrightarrow C_0^{\mathfrak{g}}(\mathcal{T}) \xrightarrow{\alpha} C_1^{\mathfrak{g}}(\mathcal{T}) \xrightarrow{\beta} J^{\mathfrak{g}}(\mathcal{T}) \xrightarrow{\beta^*} C_1^{\mathfrak{g}}(\mathcal{T}) \xrightarrow{\alpha^*} C_0^{\mathfrak{g}}(\mathcal{T}) \longrightarrow 0.$$

Note that when $n = 2$, $\mathcal{J}^{\mathfrak{g}}$ equals \mathcal{J} .

Convention 4.3. When there can be no confusion, we shall sometimes suppress the simplex Δ from the notation. For example, we sometimes write (s, e) instead of $(s, e)_\Delta$, and if t is an integral point of a simplex Δ of \mathcal{T} , we denote the corresponding integral point of \mathcal{T} by $[t]$ or sometimes just t instead of $[(t, \Delta)]$.

5. Characterization of $\text{Im}(\beta^*)$

We develop some relations in $C_1^{\mathfrak{g}}(\mathcal{T})/\text{Im}(\beta^*)$ that are needed for computing $H_2(\mathcal{J}^{\mathfrak{g}})$. These relations may be of independent interest.

5.1. Quad relations

Definition 5.1. A *quadrilateral* (*quad* for short) in Δ_n^3 is the convex hull of 4 points

$$\begin{aligned} p_0 &= a + (k, 0, 0, l), & p_1 &= a + (k, 0, l, 0), \\ p_2 &= a + (0, k, l, 0), & p_3 &= a + (0, k, 0, l), \end{aligned}$$

or the image of such under a permutation in S_4 . Here k, l are positive integers with $k + l \leq n$ and $a \in \Delta_{n-k-l}(\mathbb{Z})$. A quad determines a *quad relation* in $C_1^{\mathfrak{g}}(\mathcal{T})$ given by the alternating sum $p_0 - p_1 + p_2 - p_3$ of its corners.

Figure 11 shows three quad relations for $n = 4$.

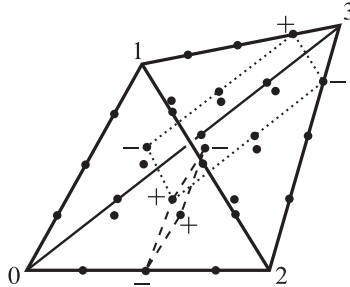

Figure 11. Quad relations.

Lemma 5.2. *A quad relation is in the image of β^* , and is thus zero in $H_2(\mathcal{J}^{\mathfrak{g}})$.*

Proof. This follows from the fact that any quad relation is a sum of the elementary quad relations in Figures 6, 7, and 8. For an algebraic proof, note that

$$p_0 - p_1 + p_2 - p_3 = \sum_{1 < i \leq k, 1 < j \leq l} \beta^*(a + (k - i, i - 1, j - 1, l - j), \varepsilon_{01}). \quad \square$$

Recall that we have divided integral points into edge points, face points and interior points. We shall need a finer division.

Definition 5.3. The *type* of a point $t \in \Delta_n(\mathbb{Z})$ is the orbit of t under the S_4 action.

Note that the type is preserved under face pairings, so it makes sense to define the type of an integral point $p = [(t, \Delta)]$ to be the type of any representative.

Proposition 5.4. *Let p and q be integral points of the same type. Then*

$$p - q \in \mathrm{Im}(\beta^*) + E,$$

where E is the subgroup of $C_1^{\mathfrak{g}}(\mathcal{T})$ generated by edge points.

Proof. We first assume that the points lie in the same simplex. The quad relation (together with similar relations obtained by permutations)

$$(a, b, c, d) - (a, b, c + d, 0) + (b, a, c + d, 0) + (b, a, c, d)$$

shows that the difference between two interior points of the same type is equal modulo $\text{Im}(\beta^*)$ to the difference between two face points of the same type. Similarly, the relation

$$(a, b, 0, c) - (a, b, c, 0) + (0, a + b, c, 0) - (0, a + b, 0, c)$$

shows that the difference between two face points (of the same type) in distinct faces is in $\text{Im}(\beta^*) + E$. Finally, the two quad relations

$$(0, a, b, c) = (a, 0, b, c) + (0, a, 0, b + c) - (a, 0, 0, b + c),$$

$$(0, a, c, b) = (a, 0, c, b) + (0, a, b + c, 0) - (a, 0, b + c, 0)$$

in $C_1^q(\mathcal{J})/\text{Im}(\beta^*)$ imply that the difference between two face points (of the same type) in the same face is also in $\text{Im}(\beta^*) + E$. This concludes the proof when the points are in the same simplex. The quad relation

$$(a, b, c, d) = (a, b, c + d, 0) - (0, b + a, c + d, 0) + (0, a + b, c, d) \tag{5.1}$$

shows that (a, b, c, d) modulo $E + \text{Im}(\beta^*)$ is a sum of face points, which we (by the above) may move to the same face. This proves the result for p and q in adjacent simplices, and the general case follows from the fact that M is connected. \square

5.2. Hexagon relations. Besides the quad relations, we shall need further relations that lie entirely in a face.

Lemma 5.5. *For any face point t , the element $\beta^*(\sum_{s+e=t}(s, e))$ is an alternating sum of the corners of a hexagon with center at t (see Figure 12).*

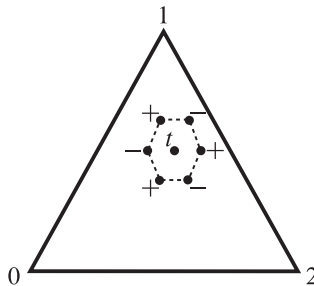

Figure 12. Hexagon relation.

Proof. By rotational symmetry, we may assume that $t = (t_0, t_1, t_2, 0)$. We thus have

$$\beta^* \left(\sum_{s+e=t} (s, e) \right) = \beta^*(t - \varepsilon_{01}, \varepsilon_{01}) + \beta^*(t - \varepsilon_{12}, \varepsilon_{12}) + \beta^*(t - \varepsilon_{02}, \varepsilon_{02}). \quad (5.2)$$

Using the formula (4.4) for β^* , (5.2) easily simplifies to

$$\begin{aligned} \beta^* \left(\sum_{s+e=t} (s, e) \right) = & -[t + (-1, 1, 0, 0)] + [t + (-1, 0, 1, 0)] - [t + (0, -1, 1, 0)] \\ & + [t + (1, -1, 0, 0)] - [t + (1, 0, -1)] + [t + (0, 1, -1, 0)]. \end{aligned}$$

This corresponds to the configuration in Figure 12. □

Definition 5.6. An element as in Lemma 5.5 is called a *hexagon relation*. By taking sums of hexagon relation, we obtain relations as shown in Figure 13. We refer to these as *long hexagon relations* (a hexagon relation is also regarded as a long hexagon relation).

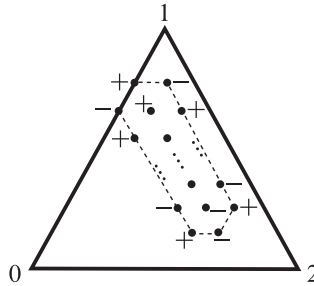

Figure 13. Long hexagon relation.

6. The outer homology groups

We focus here on the computation of $H_1(\mathcal{J}^g)$ and $H_2(\mathcal{J}^g)$; the computation of $H_5(\mathcal{J}^g)$ and $H_4(\mathcal{J}^g)$ will follow by a duality argument (see Section 6.3).

6.1. Computation of $H_1(\mathcal{J}^g)$

Proposition 6.1. $H_1(\mathcal{J}^g) = \mathbb{Z}/n\mathbb{Z}$.

Proof. Consider the map

$$\varepsilon: C_0^g(\mathcal{J}) \longrightarrow \mathbb{Z}/n\mathbb{Z}, \quad x \otimes e_k \longmapsto k.$$

We must prove that ϵ is surjective and that $\text{Ker}(\epsilon) = \text{Im}(\alpha^*)$. Surjectivity is obvious, and the inclusion $\text{Im}(\alpha^*) \subset \text{Ker}(\epsilon)$ follows from the fact that the sum of the coordinates of any point in $\Delta_n^3(\mathbb{Z})$ is n . To prove the other inclusion, let $[\sigma] \in \text{Ker}(\epsilon)/\text{Im}(\alpha^*)$, and let $\sigma = \sum_{i=1}^N \varepsilon_i x_i \otimes e_{k_i}$ be a representative with N minimal and $\varepsilon_i = \pm 1$. We wish to prove that $N = 0$, so suppose $N > 0$. We start by showing that modulo $\text{Im}(\alpha^*)$, the relations

$$x \otimes e_k + y \otimes e_{n-k} = 0, \quad x \otimes e_k - y \otimes e_k = 0 \quad (6.1)$$

hold for all 0-cells x, y . Pick an edge path of odd length between x and y with vertices $x_0 = x, x_1, \dots, x_{2k-1} = y$. For z, w vertices joined by an edge e , let $(z, w; k)$ be the edge point of \mathcal{J} corresponding to the point on e at distance k from w . Then $\alpha^*(z, w; k) = z \otimes e_k + w \otimes e_{n-k}$. We thus have

$$x \otimes e_k + y \otimes e_{n-k} = \alpha^*((x, x_1; k) - (x_1, x_2; n-k) + \dots + (x_{2k-2}, y; k)).$$

This proves the first equation in (6.1). The second follows similarly by considering an edge path of even length.

Clearly $N \neq 1$, and it follows from (6.1) that $[\sigma] = 0$ if $N = 2$. Hence, we may assume that $N \geq 3$, and also (using (6.1)) that $k_i \leq n/2$ for all i . Up to switching the sign of σ and reordering the summands, we may thus assume that

$$\sigma = x_1 \otimes e_{k_1} + x_2 \otimes e_{k_2} + \sum_{i>2} \varepsilon_i x_i \otimes e_{k_i}.$$

Fix three 0-cells x, y, z lying on a face, and let p be the unique integral point satisfying

$$\alpha^*(p) = x \otimes e_{k_1} + y \otimes e_{k_2} + z \otimes e_{n-k_1-k_2}.$$

Subtracting $\alpha^*(p)$ from σ and using (6.1), we can thus construct a representative of $[\sigma]$ with fewer than N terms, contradicting minimality of N . Hence, $\sigma = 0$. \square

6.2. Computation of $H_2(\mathcal{J}^g)$. We now prove that $H_2(\mathcal{J}^g) = H_1(\widehat{M}; \mathbb{Z}/n\mathbb{Z})$. The fact that $H_2(\mathcal{J}^g)$ is torsion is crucial, and is used in the proof of Proposition 7.9. We see no way of proving that $H_2(\mathcal{J}^g)$ is torsion without computing it explicitly.

Let $\varepsilon_{ij}^{\text{ori}}$ denote the *oriented* edge (from i to j) between i and j .

6.2.1. Definition of a map $\nu: H_2(\mathcal{J}^g) \rightarrow H_1(\widehat{M}; \mathbb{Z}/n\mathbb{Z})$. Consider the map

$$\nu: \mathbb{Z}[\widehat{\Delta}_n^3(\mathbb{Z})] \longrightarrow C_1(\Delta^3; \mathbb{Z}/n\mathbb{Z}), \quad (t_0, t_1, t_2, t_3) \longmapsto t_1 \varepsilon_{01}^{\text{ori}} + t_2 \varepsilon_{02}^{\text{ori}} + t_3 \varepsilon_{03}^{\text{ori}}. \quad (6.2)$$

Note that modulo boundaries in $C_1(\Delta^3; \mathbb{Z}/n\mathbb{Z})$, we have

$$\begin{aligned} t_1\varepsilon_{01}^{\mathrm{ori}} + t_2\varepsilon_{02}^{\mathrm{ori}} + t_3\varepsilon_{03}^{\mathrm{ori}} &= t_0\varepsilon_{10}^{\mathrm{ori}} + t_2\varepsilon_{12}^{\mathrm{ori}} + t_3\varepsilon_{13}^{\mathrm{ori}} \\ &= t_0\varepsilon_{20}^{\mathrm{ori}} + t_1\varepsilon_{21}^{\mathrm{ori}} + t_3\varepsilon_{23}^{\mathrm{ori}} \\ &= t_0\varepsilon_{30}^{\mathrm{ori}} + t_1\varepsilon_{31}^{\mathrm{ori}} + t_2\varepsilon_{32}^{\mathrm{ori}}. \end{aligned} \tag{6.3}$$

Lemma 6.2. *The map (6.2) induces a well defined map*

$$\nu: C_1^{\mathfrak{g}}(\mathcal{T}) \rightarrow C_1(\widehat{M}; \mathbb{Z}/n\mathbb{Z})/\{\text{boundaries}\}$$

which takes cycles to cycles and boundaries to 0.

Proof. If the triangulation \mathcal{T} is ordered (all face pairings are order preserving), so that all edges of \mathcal{T} are canonically oriented, the fact that ν is well defined is a simple consequence of (6.3). The general case follows from the fact that if $\varepsilon_{ij,\Delta}^{\mathrm{ori}}$ and $\varepsilon_{kl,\Delta'}^{\mathrm{ori}}$ are identified in \widehat{M} , their images in $C_1(\widehat{M})$ differ by a sign, which is positive if and only if $i - j$ and $k - l$ have the same sign. To see that cycles map to cycles consider the diagram

$$\begin{array}{ccc} C_1^{\mathfrak{g}}(\mathcal{T}) & \xrightarrow{\nu} & C_1(\widehat{M}; \mathbb{Z}/n\mathbb{Z})/\{\text{boundaries}\} \\ \alpha^* \downarrow & & \downarrow \partial \\ C_0^{\mathfrak{g}}(\mathcal{T}) & \xrightarrow{\nu_0} & C_0(\widehat{M}; \mathbb{Z}/n\mathbb{Z}), \end{array} \tag{6.4}$$

where ν_0 is the map given by

$$\nu_0: C_0^{\mathfrak{g}}(\mathcal{T}) \rightarrow C_0(\widehat{M}; \mathbb{Z}/n\mathbb{Z}), \quad x \otimes e_i \mapsto ix.$$

We must prove that (6.4) is commutative. This follows from

$$\begin{aligned} \partial(\nu(t)) &= \partial(t_1\varepsilon_{01}^{\mathrm{ori}} + t_2\varepsilon_{02}^{\mathrm{ori}} + t_3\varepsilon_{03}^{\mathrm{ori}}) \\ &= t_1(x_1 - x_0) + t_2(x_2 - x_0) + t_3(x_3 - x_0) \\ &= t_0x_0 + t_1x_1 + t_2x_2 + t_3x_3 \\ &= \nu \circ \alpha^*(t). \end{aligned}$$

We must check that ν takes $\beta^*(J^{\mathfrak{g}}(\mathcal{T}))$ to 0. By rotational symmetry, it is enough to prove that ν takes $\beta^*(s, \varepsilon_{01})$ to 0. Using (4.4) we have

$$\begin{aligned} \nu(\beta^*(s, \varepsilon_{01})) &= (s_1\varepsilon_{01}^{\mathrm{ori}} + s_2\varepsilon_{02}^{\mathrm{ori}} + (s_3 + 1)\varepsilon_{03}^{\mathrm{ori}}) \\ &\quad + ((s_1 + 1)\varepsilon_{01}^{\mathrm{ori}} + (s_2 + 1)\varepsilon_{02}^{\mathrm{ori}} + s_3\varepsilon_{03}^{\mathrm{ori}}) \\ &\quad - (s_1\varepsilon_{01}^{\mathrm{ori}} + (s_2 + 1)\varepsilon_{02}^{\mathrm{ori}} + s_3\varepsilon_{03}^{\mathrm{ori}}) \\ &\quad - ((s_1 + 1)\varepsilon_{01}^{\mathrm{ori}} + s_2\varepsilon_{02}^{\mathrm{ori}} + (s_3 + 1)\varepsilon_{03}^{\mathrm{ori}}) \\ &= 0. \end{aligned}$$

This concludes the proof. □

Hence, ν induces a map

$$\nu: H_2(\mathcal{J}^{\mathfrak{g}}) \longrightarrow H_1(\widehat{M}; \mathbb{Z}/n\mathbb{Z}).$$

6.2.2. Construction of a map $\mu: H_1(\widehat{M}; \mathbb{Z}/n\mathbb{Z}) \rightarrow H_2(\mathcal{J}^{\mathfrak{g}})$. We prove that ν is an isomorphism by constructing an explicit inverse. Let $k \in \{1, 2, \dots, n - 1\}$.

Definition 6.3. Let e be an oriented edge of \mathcal{T} . If f is a face containing e , the path consisting of the two other edges in f is called a *tooth* of e .

Given a tooth T_e of an edge e , let $\mu_k(e)_{T_e} \in C_1^{\mathfrak{g}}$ be the element shown in Figure 14.

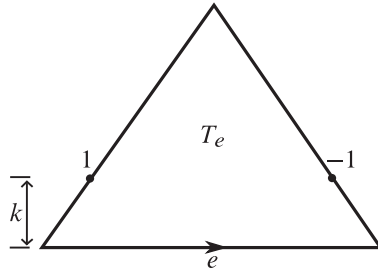

Figure 14. A tooth T_e of e and $\mu_k(e)_{T_e}$.

Lemma 6.4. For any two teeth T_e and T'_e of e , we have

$$\mu_k(e)_{T_e} = \mu_k(e)_{T'_e} \in C_1^{\mathfrak{g}}(\mathcal{T})/\text{Im}(\beta^*). \tag{6.5}$$

Proof. Since any two teeth of e are connected through a sequence of flips past simplices in the link of e , it is enough to prove the result when T_e and T'_e are teeth in a single simplex. Hence, we must prove that a configuration as in Figure 15 represents 0 in $C_1^{\mathfrak{g}}(\mathcal{T})/\text{Im}(\beta^*)$. This is a consequence of the quad relation (Definition 5.1). \square

It follows that we have a map

$$\mu_k: C_1(\widehat{M}) \longrightarrow C_1^{\mathfrak{g}}(\mathcal{T})/\text{Im}(\beta^*), \quad e \longmapsto \mu_k(e)_{T_e}. \tag{6.6}$$

We shall also consider the map $\bar{\mu}_k: C_1(\widehat{M}) \rightarrow C_1^{\mathfrak{g}}(\mathcal{T})$ taking an oriented edge e of \mathcal{T} to the integral point on e at distance k from the initial point of e . Note that if f_1 and f_2 are the first and second edge of some tooth of e , $\mu_k(e) = \bar{\mu}_k(f_1) - \bar{\mu}_{n-k}(f_2)$. This is immediate from the definition of μ_k and $\bar{\mu}_k$.

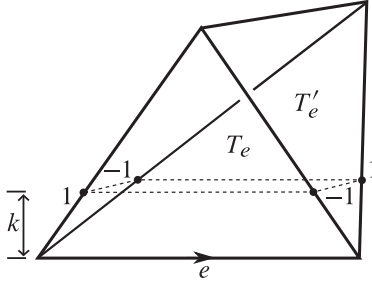

Figure 15. $\mu_k(e)_{T_e} - \mu_k(e)_{T'_e}$ is a quad relation.

Lemma 6.5. *If e_1 and e_2 are two consecutive oriented edges,*

$$\mu_k(e_1 + e_2) = \bar{\mu}_k(e_1) - \bar{\mu}_{n-k}(e_2) \in C_1^{\mathfrak{g}}(\mathcal{T}) / \text{Im}(\beta^*). \tag{6.7}$$

Proof. We must show that a configuration as in Figure 16 represents 0 in $C_1^{\mathfrak{g}}(\mathcal{T}) / \text{Im}(\beta^*)$. By flipping the teeth of e_1 and e_2 (which by Lemma 6.4 does not change the element in $C_1^{\mathfrak{g}}(\mathcal{T}) / \text{Im}(\beta^*)$), we can transform the configuration into a configuration as in Figure 17 where the two teeth meet at a common edge e (the fact that this is always possible follows from the fact that each vertex link is connected). This configuration also represents $\mu_{n-k}(e)_{T_e} - \mu_{n-k}(e)_{T'_e}$ for two teeth T_e and T'_e of e , so is zero by Lemma 6.4. \square

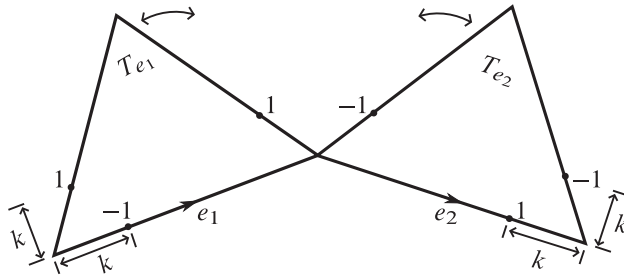

Figure 16. Configuration representing $\mu_k(e_1 + e_2) - \bar{\mu}_k(e_1) + \bar{\mu}_{n-k}(e_2)$.

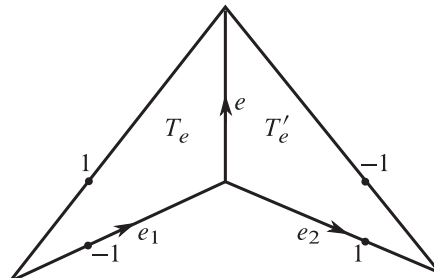

Figure 17. Configuration representing $\mu_k(e)_{T_e} - \mu_k(e)_{T'_e} = 0$.

Corollary 6.6. μ_k induces a map $\mu_k: H_1(\widehat{M}) \rightarrow H_2(\mathcal{J}^g)$.

Proof. The fact that μ_k takes cycles to cycles is immediate from the definition of α^* . Let $e_1 + e_2 + e_3$ be an oriented path representing the boundary of a face in \mathcal{T} . We have

$$\begin{aligned} \mu_k(e_1 + e_2 + e_3) &= \mu_k(e_1 + e_2) + \mu_k(e_3) \\ &= \bar{\mu}_k(e_1) - \bar{\mu}_{n-k}(e_2) + \mu_k(e_3) \\ &= -\mu_k(e_3) + \mu_k(e_3) \\ &= 0, \end{aligned}$$

where the third equality follows from the fact that $e_1 + e_2$ is a tooth of e_3 . This proves the result. \square

Lemma 6.7. We have $\mu_k = -\mu_{n-k}: H_1(\widehat{M}) \rightarrow H_2(\mathcal{J}^g)$.

Proof. Let $\alpha \in H_1(\widehat{M})$. Since $H_1(\widehat{M})$ is generated by edge cycles, we may assume that α is represented by an edge cycle $e_1 + e_2 + \cdots + e_{2l}$, which we may assume to have even length. We thus have (indices modulo $2l$)

$$\begin{aligned} \mu_k(\alpha) &= \sum_{i=1}^l (\bar{\mu}_k(e_{2i-1}) - \bar{\mu}_{n-k}(e_{2i})) \\ &= \sum_{i=1}^l (-\bar{\mu}_{n-k}(e_{2i}) + \bar{\mu}_k(e_{2i+1})) \\ &= -\mu_{n-k}(\alpha), \end{aligned} \tag{6.8}$$

where the first and third equality follow from Lemma 6.5 and the second equality follows from shifting indices by 1. \square

Lemma 6.8. For each k , we have $\mu_k = k\mu_1: H_1(\widehat{M}) \rightarrow H_2(\mathcal{J}^g)$.

Proof. Let $\alpha = e_1 + e_2 + \cdots + e_{2l}$ as in the proof of Lemma 6.7. We can represent $k\mu_1(e_i) - \mu_k(e_i)$ as in Figure 18. By applying long hexagon relations ($k - d$ relations at distance d from e_i) in the direction parallel to e_i , the configuration is equivalent to that of Figure 19. Now consider two consecutive edges e_i and e_{i+1} as in Figure 20. By flipping teeth (which doesn't change the homology class), we may transform the configuration into that of Figure 21, and by further flipping, we may assume that the configuration lies in a single simplex. It is now evident,

that the points near the common edge e represents a sum of $k - 1$ quad relations. Hence, all the points near e vanish. By flipping the teeth back, we end up with a configuration as in Figure 20, but with only points near the leftmost and rightmost edge remaining. Since α is a cycle, it follows that everything sums to zero. \square

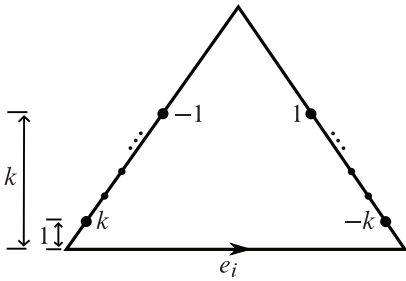

Figure 18. $k\mu_1(e_i) - \mu_k(e_i)$.

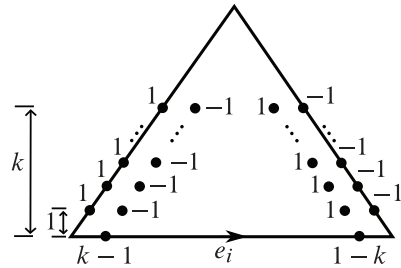

Figure 19. $k\mu_1(e_i) - \mu_k(e_i)$ after adding long hexagon relations.

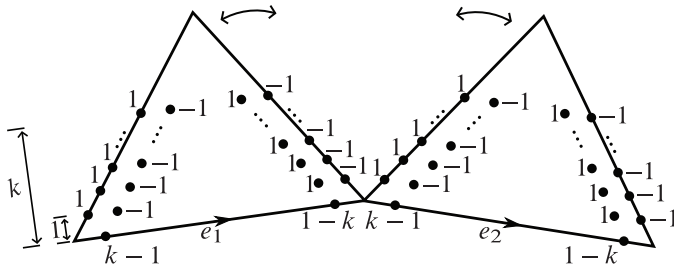

Figure 20. $k\mu_1(e_i) - \mu_k(e_i)$.

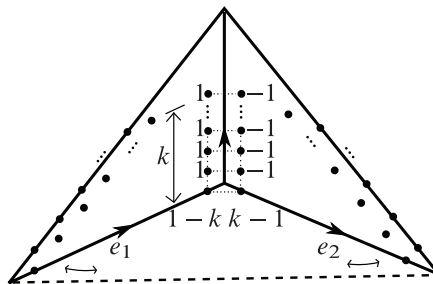

Figure 21. Figure 20 after flipping.

By the above lemmas, we have a map

$$\mu: H_1(\widehat{M}; \mathbb{Z}/n\mathbb{Z}) \longrightarrow H_2(\mathcal{J}^{\mathfrak{g}}), \quad e \otimes k \longmapsto \mu_k(e).$$

6.2.3. The map μ is the inverse of ν

Lemma 6.9. *The composition $\nu \circ \mu$ is the identity on $H_1(\widehat{M}; \mathbb{Z}/n\mathbb{Z})$.*

Proof. First observe that for each 1-cell e of \mathcal{T} , we have $\nu \circ \bar{\mu}_k(e) = ke$. Consider a representative $\alpha = e_1 + \cdots + e_{2l} \in C_1(\widehat{M}; \mathbb{Z})$ of a homology class in $H_1(\widehat{M})$. As in (6.8), we have

$$\begin{aligned} \nu \circ \mu_k(\alpha) &= \nu \left(\sum_{i=1}^l (\bar{\mu}_k(e_{2i-1}) - \bar{\mu}_{n-k}(e_{2i})) \right) \\ &= \sum_{i=1}^l e_{2i-1} \otimes k - e_{2i} \otimes (n-k) \\ &= \alpha \otimes k \in C_1(\widehat{M}; \mathbb{Z}/n\mathbb{Z}) / \{\text{boundaries}\}. \end{aligned} \tag{6.9}$$

This proves the result. \square

We now show that $\mu \circ \nu$ is the identity on $H_2(\mathcal{J}^{\mathfrak{g}})$. The idea is that every homology class in $H_2(\mathcal{J}^{\mathfrak{g}})$ can be represented by edge points. Consider the set

$$T = \{(t_0, t_1, t_2, 0) \in \dot{\Delta}_n^3(\mathbb{Z}) : t_0 \geq t_1 \geq t_2 \geq 0\}$$

of points on a face of a fixed simplex of \mathcal{T} . By Proposition 5.4 (and (5.1)), we can represent each homology class in $H_2(\mathcal{J}^{\mathfrak{g}})$ by an element $\tau + e$, where e consists entirely of edge points, and τ consists of terms in T . Note that by adding and subtracting edge points in T to τ , one may further assume that $\alpha^*(\tau) = 0$. Hence, we shall study elements in $\text{Ker}(\alpha^*)$ of the form

$$\tau = \sum_{t \in T} k_t t, \quad k_t \in \mathbb{Z}.$$

We say that a term $t \in T$ is *in* τ if $k_t \neq 0$. For $j = 1, \dots, n-1$, consider the map

$$\pi_j: C_0^{\mathfrak{g}}(\mathcal{T}) \longrightarrow \mathbb{Z}, \quad x \otimes e_i \longmapsto \delta_{ij},$$

where δ_{ij} is the Kronecker δ . For $k \in \mathbb{N}$, let $\tau_{t_i=k} = \sum_{t_i=k} k_t t$ be the sum of the terms in τ with $t_i = k$.

Lemma 6.10. *For any $k > n/2$, $\tau_{t_0=k}$ is a linear combination of terms of the form*

$$C_{t_1, t'_1, k} = (k, t_1, t_2, 0) - (k, t'_1, t'_2, 0), \quad t_1 > t'_1.$$

Proof. It is enough to prove that $\sum_{t_0=k} k_t = 0$. Since $\alpha^*(\tau) = 0$, this follows from

$$0 = \pi_k \circ \alpha^*(\tau) = \pi_k \circ \alpha^*(\tau_{t_0=k}) = \sum_{t_0=k} k_t,$$

which is an immediate consequence of the definition of α^* . □

Proposition 6.11. *The kernel of $\alpha^*: C_1^{\mathfrak{g}}(\mathcal{T}) \rightarrow C_0^{\mathfrak{g}}(\mathcal{T})$ is generated modulo $\mathrm{Im}(\beta^*)$ by edge points. In other words, each homology class can be represented by edge points.*

Proof. Let $x \in H_2(\mathcal{J}^{\mathfrak{g}})$. As explained above, we can represent x by an element $\tau + e$, where e consists entirely of edge points, and $\tau = \sum_{t \in T} k_t t \in \mathrm{Ker}(\alpha^*)$. We wish to show that τ is a linear combination of long hexagon relations. We start by inductively decreasing the maximal value t_0^{\max} of t_0 among the terms in τ by adding long hexagon relations in the direction parallel to the edge opposite vertex 0. More specifically, one adds the long hexagon relations with corners at the two terms involved in $C_{t_1, t'_1, t_0^{\max}}$ (see Figure 22).

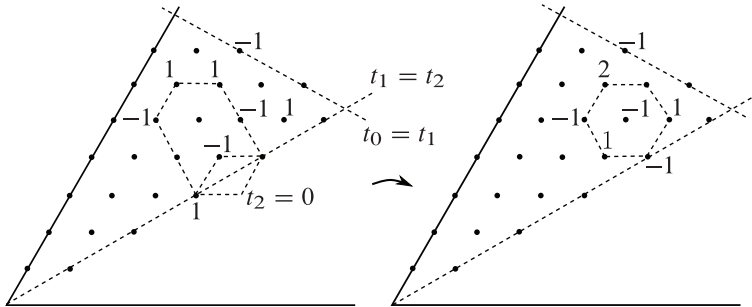

Figure 22. Driving terms up by adding long hexagon relations.

If a long hexagon has a vertex outside of t , this vertex is replaced by the unique vertex in T of the same type. By Lemma 6.10 we can remove all terms with $t_0 > n/2$ in this way. We then continue adding long hexagon relations until we end up with a configuration τ' , where all terms satisfy that $t_0 - t_1 \leq 2$, i.e. where all terms are either on the line $t_0 = t_1$ or on the saw shaped curve in Figure 23. Note that for any k , the number x_k of terms in τ' with $t_2 = k$ is either 0, 1, or 2.

Using that $\pi_k \circ \alpha^*(\tau') = 0$, we see that x_k can't be 1, and that if $x_k = 2$, the coefficient of the term with $t_0 > t_1$ is -2 times the coefficient of the term with $t_0 = t_1$. Hence, all terms of τ' lie on the square indicated in Figure 23. But this contradicts that $\alpha^*(\tau') = 0$, since the corner terms of the square can't cancel. It thus follows that $\tau' = 0$, hence, that τ is a sum of long hexagon relations, hence 0 in $H_2(\mathcal{J}^g)$. This proves the result. \square

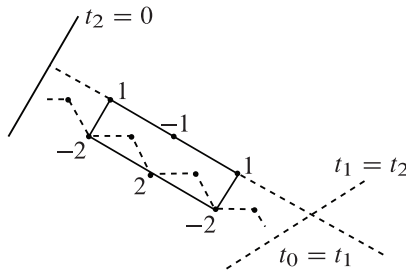

Figure 23. Final configuration.

Corollary 6.12. *The composition $\mu \circ \nu$ is the identity on $H_2(\mathcal{J}^g)$.*

Proof. By Proposition 6.11, one may represent a class in $H_2(\mathcal{J}^g)$ by a linear combination x of edge points. Since $\alpha^*(x) = 0$, x must be a linear combination of elements of the form

$$\sigma = \sum_{i=1}^l (\bar{\mu}_k(e_{2i}) - \bar{\mu}_{n-k}(e_{2i-1}))$$

This follows from the well known fact that the cycles in $C_1(\widehat{M})$ are generated by edge loops. We now have

$$\mu \circ \nu(\sigma) = \mu((e_1 + \dots + e_{2l}) \otimes k) = \mu_k(e_1 + \dots + e_{2l}) = \sigma,$$

where the first equality follows from (6.9), and the third from Lemma 6.5. \square

The following now follows from Lemma 6.9 and Corollary 6.12.

Proposition 6.13. *We have an isomorphism $H_2(\mathcal{J}^g) \cong H_1(\widehat{M}; \mathbb{Z}/n\mathbb{Z})$.*

6.3. Computation of $H_4(\mathcal{J}^{\mathfrak{g}})$ and $H_5(\mathcal{J}^{\mathfrak{g}})$. Since $\mathcal{J}^{\mathfrak{g}}$ is self dual, the universal coefficient theorem implies that

$$H_k(\mathcal{J}^{\mathfrak{g}}) = H_{6-k}((\mathcal{J}^{\mathfrak{g}})^*) \cong \mathrm{Hom}(H_{6-k}(\mathcal{J}^{\mathfrak{g}}), \mathbb{Z}) \oplus \mathrm{Ext}(H_{6-k-1}(\mathcal{J}^{\mathfrak{g}}), \mathbb{Z}). \quad (6.10)$$

It follows from Propositions 6.1 and 6.13 that $H_5(\mathcal{J}^{\mathfrak{g}}) = 0$ and $H_4(\mathcal{J}^{\mathfrak{g}}) = \mathbb{Z}/n\mathbb{Z}$.

Remark 6.14. One can show that the sum τ of all integral points of \mathcal{T} generates $H_4(\mathcal{J}^{\mathfrak{g}}) = \mathbb{Z}/n\mathbb{Z}$. If M has a single boundary component, corresponding to the 0-cell x of \mathcal{T} , we have

$$n\tau = \alpha \left(\sum_{i=1}^{n-1} ix \otimes e_i \right).$$

We shall not need this, so we leave the proof to the reader.

7. The middle homology group

By (6.10) and Proposition 6.13, the torsion in $H_3(\mathcal{J}^{\mathfrak{g}})$ equals $\mathrm{Ext}(H_1(\widehat{M}; \mathbb{Z}/n\mathbb{Z}), \mathbb{Z})$, which is isomorphic to $H^1(\widehat{M}; \mathbb{Z}/n\mathbb{Z})$. We now analyze the free part. Following Neumann [17, Section 4], the idea is to construct maps

$$\delta: H_1(\partial M; \mathbb{Z}^{n-1}) \longrightarrow H_3(\mathcal{J}^{\mathfrak{g}}), \quad \gamma: H_3(\mathcal{J}^{\mathfrak{g}}) \longrightarrow H_1(\partial M; \mathbb{Z}^{n-1}),$$

which are adjoint with respect to the intersection form w on $H_1(\partial M; \mathbb{Z}^{n-1})$ and the form Ω on $H_3(\mathcal{J}^{\mathfrak{g}})$. When $n = 2$, our δ and γ agree with those of [17].

7.1. Cellular decompositions of the boundary. The ideal triangulation \mathcal{T} of M induces a decomposition of M into truncated simplices such that the cut-off triangles triangulate the boundary of M . We call this decomposition of ∂M the *standard decomposition* and denote it by $\mathcal{T}_{\partial M}^{\Delta}$ (see Figure 24). The superscript Δ is to stress that the 2-cells are triangles. We shall also consider another decomposition of ∂M , the *polygonal decomposition* $\mathcal{T}_{\partial M}^{\square}$, which is obtained from $\mathcal{T}_{\partial M}^{\Delta}$ by replacing the link of each vertex v of $\mathcal{T}_{\partial M}^{\Delta}$ with the polygon whose vertices are the midpoints of the edges incident to v (see Figure 25). The polygonal decomposition thus has a vertex for each edge of $\mathcal{T}_{\partial M}^{\Delta}$, three edges for each face of $\mathcal{T}_{\partial M}^{\Delta}$, and two types of faces; a *triangular face* for each face of $\mathcal{T}_{\partial M}^{\Delta}$, and a *polygonal face* (which may or may not be a triangle) for each vertex of $\mathcal{T}_{\partial M}^{\Delta}$.

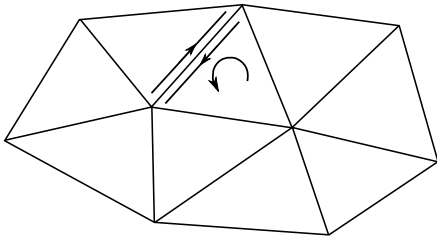

Figure 24. The standard decomposition.

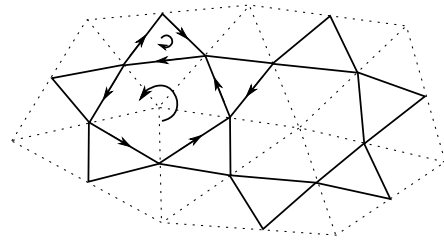

Figure 25. The polyhedral decomposition.

We denote the cellular chain complexes corresponding to the two decompositions by $C_*(\mathcal{T}_{\partial M}^\Delta)$ and $C_*(\mathcal{T}_{\partial M}^\diamond)$, respectively. Hence, we have canonical isomorphisms

$$H_*(C_*(\mathcal{T}_{\partial M}^\diamond)) = H_*(C_*(\mathcal{T}_{\partial M}^\Delta)) = H_*(\partial M).$$

7.1.1. Labeling and orientation conventions. We orient ∂M with the counter-clockwise orientation as viewed from an ideal point. The edges of $\mathcal{T}_{\partial M}^\diamond$ each lie in a unique simplex of \mathcal{T} and we orient them in the unique way that agrees with the counter-clockwise orientation for a polygonal face, and the clockwise orientation for a triangular face. The triangular faces of $\mathcal{T}_{\partial M}^\diamond$ are thus oriented opposite to the orientation inherited from ∂M . An edge of $\mathcal{T}_{\partial M}^\Delta$ is only naturally oriented after specifying which simplex it belongs to. See Figure 26.

The vertex of $\mathcal{T}_{\partial M}^\diamond$ near the i th vertex of Δ on the face opposite the j th vertex is denoted by v_{Δ}^{ij} , and the vertex of $\mathcal{T}_{\partial M}^\Delta$ near the i th vertex on the edge ij is denoted by V_{Δ}^{ij} . The (oriented) edge of $\mathcal{T}_{\partial M}^\diamond$ near vertex i and perpendicular to edge ij of Δ is denoted by e_{Δ}^{ij} , and the (oriented) edge of $\mathcal{T}_{\partial M}^\Delta$ near vertex i and parallel to the edge jk of Δ is denoted by E_{Δ}^{ijk} . The triangular 2-faces of $\mathcal{T}_{\partial M}^\diamond$ and $\mathcal{T}_{\partial M}^\Delta$ are denoted by τ_{Δ}^i and T_{Δ}^i , respectively, where i is the nearest vertex of Δ . The polygonal 2-face of $\mathcal{T}_{\partial M}^\diamond$ whose boundary edges are e_{Δ}^{ij} is denoted by $p^{\{i,j\}}$. The subscript Δ will occasionally be omitted (e.g. when only one simplex is involved).

7.2. The intersection form ω . Let ι denote the intersection form on $H_1(\partial M)$ and let $\langle \cdot, \cdot \rangle$ denote the canonical inner product on \mathbb{Z}^{n-1} . Consider the pairing

$$\omega: H_1(\partial M; \mathbb{Z}^{n-1}) \times H_1(\partial M; \mathbb{Z}^{n-1}) \longrightarrow \mathbb{Z}, \quad (\lambda \otimes v, \mu \otimes w) \longmapsto \iota(\lambda, \mu)\langle v, w \rangle$$

where λ and μ are in $H_1(\partial M)$, and v and w in \mathbb{Z}^{n-1} . We shall refer to ω as the *intersection form* on $H_1(\partial M; \mathbb{Z}^{n-1})$.

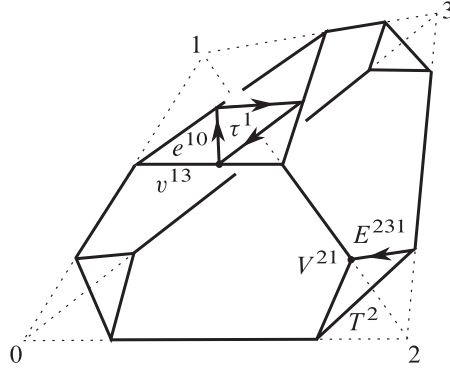

Figure 26. Labeling of vertices, edges and faces of $\mathcal{T}_{\partial M}^\Delta$ and $\mathcal{T}_{\partial M}^\square$.

7.3. Definition of δ . Define

$$\delta: C_1(\mathcal{T}_{\partial M}^\square; \mathbb{Z}^{n-1}) \longrightarrow J^{\mathfrak{g}}(\mathcal{T}), \quad e_{\Delta}^{ij} \otimes e_r \longmapsto \sum_{t_i=r} \sum_{s+e=t} t_j(s, e). \quad (7.1)$$

Remark 7.1. In (7.1) and in many other places, the symbol $\sum_{t_i=k}$ means a sum over terms $t = (t_0, t_1, t_2, t_3) \in \Delta_n^3(\mathbb{Z})$ with $t_i = k$. Similarly, the symbol $\sum_{s_i=k}$ means a sum over subsimplices $s \in \Delta_{n-2}^3$ with $s_i = k$.

Note that δ preserves rotational symmetry, i.e. it is a map of $\mathbb{Z}[A_4]$ -modules, where A_4 acts trivially on \mathbb{Z}^{n-1} .

Proposition 7.2. *The map δ induces a map*

$$\delta: H_1(\partial M; \mathbb{Z}^{n-1}) \longrightarrow H_3(\mathfrak{g}^{\mathfrak{g}}).$$

Proof. The result will follow by proving that there is a commutative diagram

$$\begin{array}{ccccc} C_2(\mathcal{T}_{\partial M}^\square; \mathbb{Z}^{n-1}) & \xrightarrow{\partial} & C_1(\mathcal{T}_{\partial M}^\square; \mathbb{Z}^{n-1}) & \xrightarrow{\partial} & C_0(\mathcal{T}_{\partial M}^\square; \mathbb{Z}^{n-1}) \\ \downarrow \delta_2 & & \downarrow \delta_1 & & \downarrow \delta_0 \\ C_1^{\mathfrak{g}}(\mathcal{T}) & \xrightarrow{\beta} & J^{\mathfrak{g}}(\mathcal{T}) & \xrightarrow{\beta^*} & C_1^{\mathfrak{g}}(\mathcal{T}). \end{array}$$

Define δ_2 by

$$p^{i_1 i_2 j_1 j_2} \otimes e_r \longmapsto \sum_{l=1}^m \sum_{t_l=r} t_{j_l}[(t, \Delta_l)], \quad \tau_{\Delta}^i \otimes e_r \longmapsto \sum_{t_i=r} (n-r)[t, \Delta].$$

Commutativity of the lefthand square can be proved geometrically by inspecting Figures 27, 28, and 29. An algebraic proof for triangular faces follows from

$$\begin{aligned}
 \delta \circ \partial(\tau_{\Delta}^i \otimes e_r) &= \sum_{j \neq i} \delta(e_{\Delta}^{ij} \otimes e_r) \\
 &= \sum_{t_i=r} \sum_{s+e=t} \sum_{j \neq i} t_j(s, e) \\
 &= \sum_{t_i=r} \sum_{s+e=t} (n - t_i)(s, e) \\
 &= \beta \circ \delta_2(\tau_{\Delta}^i \otimes e_r).
 \end{aligned}$$

Note that $\beta^* \circ \delta(e^{ij} \otimes e_r) = \sum_{t_i=r} t_j \beta^*(\sum_{s+e=t} (s, e))$, which is a sum of hexagon relations (interior terms cancel). These involve only points on the faces determined by the start and end point of e , proving the existence of δ_0 . \square

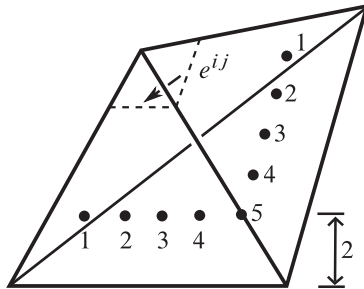

Figure 27. $\delta(e^{ij} \otimes e_2)$ for $n = 7$. Each dot represents an integral point t contributing a term $\sum_{s+e=t} (s, e)$. Interior terms are not shown, c.f. Remark 7.3.

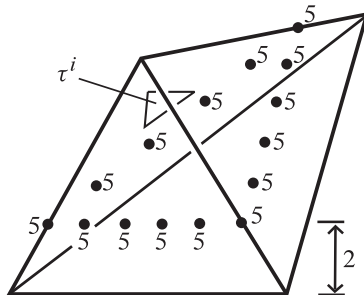

Figure 28. $\delta_2(\tau^i \otimes e_2)$ for $n = 7$. Interior terms not shown.

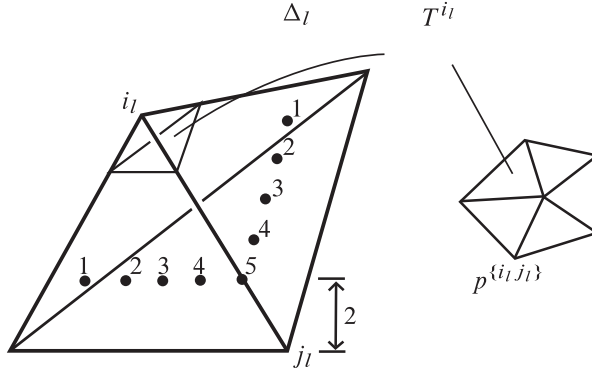

Figure 29. $\delta_2(p^{\{i_l j_l\}} \otimes e_2)$ for $n = 7$. Interior terms not shown.

Remark 7.3. In the formula for δ interior points may be ignored. This is because if t is an interior point, then

$$\sum_{s+e=t} t_j(s, e) = t_j \beta(t) \in \mathrm{Im}(\beta).$$

7.4. Definition of γ . The group A_4 acts transitively on the set of pairs of opposite edges of a simplex with stabilizer

$$D_4 = \langle \mathrm{id}, (01)(23), (02)(13), (03)(12) \rangle \subset A_4.$$

Hence, there is a one-one correspondence between D_4 -cosets in A_4 and pairs of opposite edges. Explicitly,

$$\begin{aligned} \Phi: A_4/D_4 &\longrightarrow \{ \{ \varepsilon_{01}, \varepsilon_{23} \}, \{ \varepsilon_{12}, \varepsilon_{03} \}, \{ \varepsilon_{02}, \varepsilon_{13} \} \} \\ D_4 &\longmapsto \{ \varepsilon_{01}, \varepsilon_{23} \}, \\ (012)D_4 &\longmapsto \{ \varepsilon_{12}, \varepsilon_{03} \}, \\ (021)D_4 &\longmapsto \{ \varepsilon_{02}, \varepsilon_{13} \}. \end{aligned}$$

Consider the map

$$\begin{aligned} \gamma: J^{\mathfrak{g}}(\mathcal{J}) &\longrightarrow C_1(\mathcal{J}_{\partial M}^{\Delta}; \mathbb{Z}^{n-1}), \\ (s, e) &\longmapsto \sum_{\sigma \in \Phi^{-1}(\{e, \bar{e}\})} E^{\sigma(1)\sigma(2)\sigma(3)} \otimes v_{s, \sigma(1)}, \quad v_{s, i} = e_{s_i+1} - e_{s_i}. \end{aligned}$$

The map γ is illustrated in Figures 30, 31, and 32. For example, we have

$$\gamma(s, \varepsilon_{01}) = \gamma(s, \varepsilon_{23}) = E^{032} \otimes v_{s,0} + E^{123} \otimes v_{s,1} + E^{210} \otimes v_{s,2} + E^{301} \otimes v_{s,3}.$$

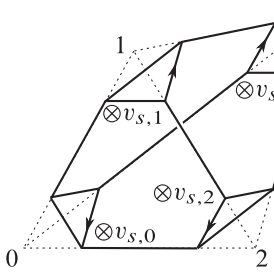

Figure 30. $\gamma(s, \varepsilon_{01})$.

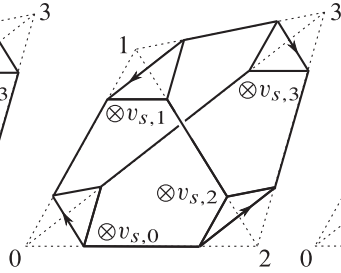

Figure 31. $\gamma(s, \varepsilon_{12})$.

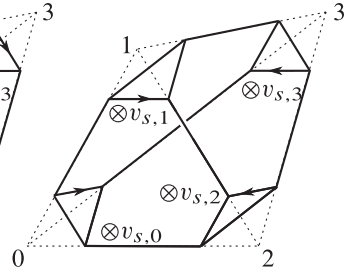

Figure 32. $\gamma(s, \varepsilon_{02})$.

To see that γ is well defined, note that $(s, \varepsilon_{01}) + (s, \varepsilon_{12}) + (s, \varepsilon_{02})$ maps to the boundary of $\sum_{i=0}^3 T^i \otimes v_{s,i}$.

Lemma 7.4. γ takes cycles to cycles and boundaries to boundaries.

Proof. We wish to show that γ fits in a commutative diagram

$$\begin{array}{ccccc}
 C_1^{\mathfrak{g}}(\mathcal{T}) & \xrightarrow{\beta} & J^{\mathfrak{g}}(\mathcal{T}) & \xrightarrow{\beta^*} & C_1^{\mathfrak{g}}(\mathcal{T}) \\
 \downarrow \gamma_2 & & \downarrow \gamma & & \downarrow \gamma_0 \\
 C_2(\mathcal{T}_{\partial M}^{\Delta}; \mathbb{Z}^{n-1}) & \xrightarrow{\partial} & C_1(\mathcal{T}_{\partial M}^{\Delta}; \mathbb{Z}^{n-1}) & \xrightarrow{\partial} & C_0(\mathcal{T}_{\partial M}^{\Delta}; \mathbb{Z}^{n-1}),
 \end{array}$$

where γ_2 and γ_0 are defined by

$$\gamma_2(p) = \begin{cases} \sum_{(t,\Delta) \in p} \sum_{i:t_i > 0} T_{\Delta}^i \otimes (e_{t_i} - e_{t_i-1}), & p = \text{edge point,} \\ \sum_{(t,\Delta) \in p} \sum_i T_{\Delta}^i \otimes (e_{t_i} - e_{t_i-1}), & p = \text{face point,} \\ \sum_{(t,\Delta) \in p} \sum_i T_{\Delta}^i \otimes (e_{t_{i+1}} - e_{t_i-1}), & p = \text{interior point,} \end{cases}$$

$$\gamma_0(p) = - \sum_{i,j} t_j V_{\Delta}^{ij} \otimes e_{t_i}.$$

In the formula for γ_0 , (t, Δ) is any representative of p . Commutativity of the lefthand side is shown for edge points in Figure 33. On the left, the six E^{ijk} edges parallel to the edge containing p cancel, and on the right, identified edges cancel. The remaining terms are thus the same on the left and on the right. We leave the similar geometric proofs for face points and interior points to the reader.

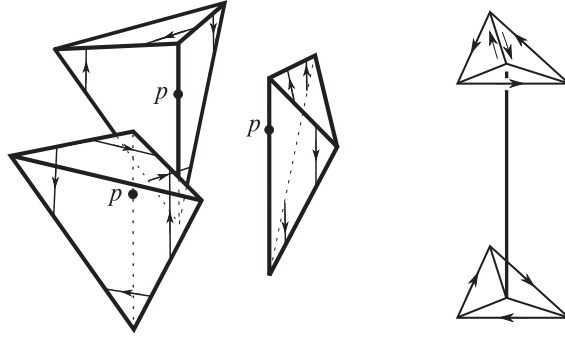

Figure 33. $\gamma \circ \beta(p)$ and $\partial \circ \gamma_2(p)$ for an edge point p .

To prove commutativity of the righthand side it is by rotational symmetry enough to consider (s, ε_{01}) . We have

$$\begin{aligned}
 \partial \circ \gamma(s, \varepsilon_{01}) &= (V^{02} - V^{03}) \otimes (e_{s_0+1} - e_{s_0}) \\
 &\quad + (V^{13} - V^{12}) \otimes (e_{s_1+1} - e_{s_1}) \\
 &\quad + (V^{23} - V^{22}) \otimes (e_{s_2+1} - e_{s_2}) \\
 &\quad + (V^{31} - V^{30}) \otimes (e_{s_3+1} - e_{s_3}).
 \end{aligned}
 \tag{7.2}$$

When expanding $\gamma_0 \circ \beta^*(s, \varepsilon_{01})$, one gets a sum of twelve (possibly vanishing) terms of the form $C_{ij} V^{ij} \otimes w_{ij}$, where $C_{ij} \in \mathbb{Z}$, $w_{ij} \in \mathbb{Z}^{n-1}$, and one must check that the terms agree with (7.2) (for example, we must have $C_{03} = 1$, $w_{03} = e_{s_0+1} - e_{s_0}$). We check this for the terms involving V^{01} and V^{02} , and leave the verification of the other terms to the reader. Since,

$$\beta^*(s, \varepsilon_{01}) = [s + \varepsilon_{03}] + [s + \varepsilon_{12}] - [s + \varepsilon_{02}] - [s + \varepsilon_{13}],$$

the term of $\gamma_0 \circ \beta^*(s, e)$ involving V^{01} equals

$$s_1 V^{01} \otimes e_{s_0+1} + (s_1 + 1) V^{01} \otimes e_{s_0} - s_1 V^{01} \otimes e_{s_0+1} - (s_1 + 1) V^{01} \otimes e_{s_0} = 0.$$

Similarly, the term involving V^{02} equals

$$\begin{aligned}
 &-s_2 V^{02} \otimes e_{s_0+1} - (s_2 + 1) V^{02} e_{s_0} + (s_2 + 1) V^{02} \otimes e_{s_0+1} + s_2 V^{02} \otimes e_{s_0} \\
 &= V^{02} \otimes (e_{s_0+1} - e_{s_0}).
 \end{aligned}$$

This proves the result. □

Hence, we have

$$\gamma: H_3(J^{\mathfrak{g}}) \longrightarrow H_1(\partial M; \mathbb{Z}^{n-1}).$$

Proposition 7.5. *The maps δ and γ are adjoint, i.e. we have*

$$\Omega(\delta(\lambda \otimes e_r), \kappa) = \omega(\lambda \otimes e_r, \gamma(\kappa)),$$

where $\lambda \in H_1(\partial M)$ and $\kappa \in H_3(\mathfrak{J}^{\mathfrak{g}})$.

Proof. $\Omega(\delta(\lambda \otimes e_r), \kappa)$ is a sum of local contributions $\Omega(\delta(e^{ij} \otimes e_r), (s, \varepsilon_{01}))$. By rotational symmetry it is enough to consider $e = \varepsilon_{01}$. We have

$$\Omega(\delta(e^{ij} \otimes e_r), (s, \varepsilon_{01})) = \Omega\left(\sum_{t_i=r} \sum_{s+\varepsilon=t} t_j(s, \varepsilon), (s, \varepsilon_{01})\right).$$

Since $\Omega((s', e'), (s, e)) = 0$ when $s \neq s'$, it follows that

$$\Omega(\delta(e^{ij} \otimes e_r), (s, \varepsilon_{01})) = \begin{cases} \Omega\left(\sum_{\varepsilon_i=0} (s_j + \varepsilon_j)(s, \varepsilon), (s, \varepsilon_{01})\right) & \text{if } s_i = r, \\ \Omega\left(\sum_{\varepsilon_i=1} (s_j + \varepsilon_j)(s, \varepsilon), (s, \varepsilon_{01})\right) & \text{if } s_i = r - 1, \\ 0 & \text{otherwise.} \end{cases}$$

An inspection of Figure 2 shows that this further simplifies to

$$\Omega(\delta(e^{ij} \otimes e_r), (s, \varepsilon_{01})) = \Omega(\varepsilon_{ij}, \varepsilon_{01}) \langle e_r, v_{s,i} \rangle.$$

As illustrated in Figure 34, it is now easy to see that the local contributions add up to $\omega(\lambda \otimes e_r, \gamma(\kappa))$. This proves the result. □

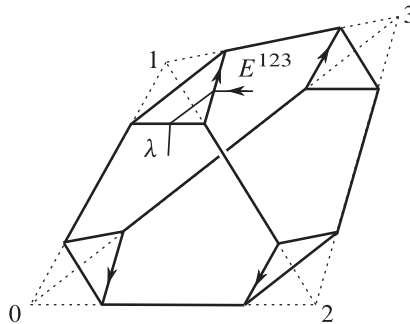

Figure 34. $\iota(\lambda, E^{123}) = -1 = \Omega(\varepsilon_{12}, \varepsilon_{01})$.

It will be convenient to rewrite the formula for δ .

Lemma 7.6. *We have*

$$\delta(e^{ij} \otimes e_r) = \sum_{s_i=r-1} (s, \varepsilon_{ij}) - \sum_{s_i=r} (s, \varepsilon_{kl}),$$

where k and l are such that $\{i, j, k, l\} = \{0, 1, 2, 3\}$.

Proof. By rotational symmetry, we may assume that $i = 0$ and $j = 1$. Using the relations (4.1) and (4.2), we have

$$\begin{aligned} \delta(e^{01} \otimes e_r) &= \sum_{t_0=r} \sum_{s+e=t} t_1(s, e) \\ &= \sum_{s_0=r-1} (s_1 + 1)(s, \varepsilon_{01}) + \sum_{s_0=r} s_1(s, \varepsilon_{23}) \\ &\quad + \sum_{s_0=r-1} s_1(s, \varepsilon_{02}) + \sum_{s_0=r} (s_1 + 1)(s, \varepsilon_{13}) \\ &\quad + \sum_{s_0=r-1} s_1(s, \varepsilon_{03}) + \sum_{s_0=r} (s_1 + 1)(s, \varepsilon_{12}) \\ &= \sum_{s_0=r-1} (s, \varepsilon_{01}) - \sum_{s_0=r} (s, \varepsilon_{23}). \end{aligned}$$

This proves the result. □

Lemma 7.7. *Let $D = \mathrm{diag}(n - 1, n - 2, \dots, 1)$ and let $A_{\mathfrak{g}}$ denote the Cartan matrix of \mathfrak{g} . We have*

$$\gamma \circ \delta(e^{ij} \otimes e_r) = E^{ikl} \otimes \left(\frac{1}{2} D A_{\mathfrak{g}} D e_r \right) + (E^{jlk} + E^{kij} + E^{lji}) \otimes e_{n-r}.$$

where k and l are such that the permutation taking $ijkl$ to 0123 is negative.

Proof. We may assume that $i = 0$ and $j = 1$. Then $k = 3$ and $l = 2$. One thus has

$$\begin{aligned} \gamma \circ \delta(e^{01} \otimes e_r) &= \sum_{s_0=r-1} \gamma(s, \varepsilon_{01}) - \sum_{s_0=r} \gamma(s, \varepsilon_{23}) \\ &= \sum_{s_0=r-1} E^{123} \otimes (e_r - e_{r-1}) - \sum_{s_0=r} E^{123} \otimes (e_{r+1} - e_r) \\ &\quad + \sum_{s_0=r-1} E^{032} \otimes (e_{s_1+1} - e_{s_1}) - \sum_{s_0=r} E^{032} \otimes (e_{s_1+1} - e_{s_1}) \\ &\quad + \sum_{s_0=r-1} E^{210} \otimes (e_{s_2+1} - e_{s_2}) - \sum_{s_0=r} E^{210} \otimes (e_{s_2+1} - e_{s_2}) \\ &\quad + \sum_{s_0=r-1} E^{301} \otimes (e_{s_3+1} - e_{s_3}) - \sum_{s_0=r} E^{301} \otimes (e_{s_3+1} - e_{s_3}). \end{aligned} \tag{7.3}$$

The number of subsimplices with $s_1 = c$ equals $\frac{1}{2}(n-c)(n-c-1)$. We thus have

$$\begin{aligned} & \sum_{s_0=r-1} (e_r - e_{r-1}) - \sum_{s_0=r} (e_{r+1} - e_r) \\ &= -\frac{1}{2}(n-r+1)(n-r)e_{r-1} + (n-r)^2e_r - \frac{1}{2}(n-r)(n-r-1)e_{r+1} \quad (7.4) \\ &= \frac{1}{2}DA_{\mathfrak{g}}De_r. \end{aligned}$$

By telescoping, we have

$$\begin{aligned} & \sum_{s_0=r-1} E^{xyz} \otimes (e_{s_i+1} - e_{s_i}) - \sum_{s_0=r} E^{xyz} \otimes (e_{s_i+1} - e_{s_i}) \\ &= E^{xyz} \otimes \sum_{m=0}^{n-1-r} (e_{m+1} - e_m) \quad (7.5) \\ &= E^{xyz} \otimes e_{n-r}. \end{aligned}$$

Plugging (7.4) and (7.5) into (7.3) we end up with

$$\begin{aligned} & \gamma \circ \delta(e^{01} \otimes e_r) \\ &= E^{032} \otimes \frac{1}{2}DA_{\mathfrak{g}}De_r + E^{123} \otimes e_{n-r} + E^{210} \otimes e_{n-r} + E^{301} \otimes e_{n-r}, \end{aligned}$$

which proves the result. □

Proposition 7.8. *The composition $\gamma \circ \delta: H_1(\partial M; \mathbb{Z}^{n-1}) \rightarrow H_1(\partial M; \mathbb{Z}^{n-1})$ is given by*

$$\gamma \circ \delta = \text{id} \otimes DA_{\mathfrak{g}}D.$$

Proof. Let $\alpha = \sum a_m e_{\Delta_m}^{i_m j_m}$ be a cycle in $C_1(\mathcal{T}_{\partial M}^{\diamond})$. In the proof of [17, Lemma 4.3] (see also Bergeron, Falbel, and Guilloux [2, Figures 12 and 13]), Neumann proves that the “near contribution”

$$\sum a_m E^{i_m k_m l_m}$$

is homologous to 2α , whereas the “far contribution”

$$\sum a_m (E^{j_m l_m k_m} + E^{k_m i_m j_m} + E^{l_m j_m i_m})$$

is null-homologous. The result now follows from Lemma 7.7. □

Proposition 7.9. *The groups $H_3(\mathcal{J}^{\mathfrak{g}})$ and $H_1(\partial M; \mathbb{Z}^{n-1})$ have equal rank.*

Proof. Since all the outer homology groups have rank 0, the rank of $H_3(\mathcal{J})$ is the Euler characteristic $\chi(\mathcal{J})$ of \mathcal{J} . Let v, ϵ, ψ , and τ denote the number of vertices, edges, faces and tetrahedra, respectively, of \mathcal{J} . By a simple counting argument we have

$$\begin{aligned} \mathrm{rank}(C_0^{\mathfrak{g}}(\mathcal{J})) &= (n-1)v, & \mathrm{rank}(\mathcal{J}^{\mathfrak{g}}(\mathcal{J})) &= 2\binom{n+1}{3}\tau, \\ \mathrm{rank}(C_1^{\mathfrak{g}}(\mathcal{J})) &= (n-1)\epsilon + \frac{(n-1)(n-2)}{2}\psi + \frac{(n-1)(n-2)(n-3)}{6}\tau. \end{aligned}$$

Using the fact that $\psi = 2\tau$ we obtain

$$\begin{aligned} \chi(\mathcal{J}) &= 2\mathrm{rank}(C_0^{\mathfrak{g}}(\mathcal{J})) - 2\mathrm{rank}(C_1^{\mathfrak{g}}(\mathcal{J})) + \mathrm{rank}(\mathcal{J}^{\mathfrak{g}}(\mathcal{J})) \\ &= 2(n-1)(v - \epsilon + \tau) = 2(n-1)(v - \epsilon + \psi - \tau) \\ &= 2(n-1)\chi(\widehat{M}). \end{aligned}$$

The result now follows from the elementary fact (proved by an Euler characteristic count) that $\chi(\widehat{M}) = 1/2 \mathrm{rank}(H_1(\partial M))$. \square

Corollary 7.10. *The groups $H_3(\mathcal{J}^{\mathfrak{g}})$ and $H_1(\partial M; \mathbb{Z}^{n-1})$ are isomorphic modulo torsion.*

7.5. Proof of Theorem 2.9. We now conclude the proof of Theorem 2.9. All that remains are the statements about the free part of $H_3(\mathcal{J}^{\mathfrak{g}})$. We first show that γ and δ admit factorizations

$$\begin{aligned} \delta: H_1(\partial M; \mathbb{Z}^{n-1}) &\xrightarrow{\mathrm{id} \otimes D} H_1(\partial M; \mathbb{Z}^{n-1}) \xrightarrow{\delta'} H_3(\mathcal{J}^{\mathfrak{g}}), \\ \gamma: H_3(\mathcal{J}^{\mathfrak{g}}) &\xrightarrow{\gamma'} H_1(\partial M; \mathbb{Z}^{n-1}) \xrightarrow{\mathrm{id} \otimes D} H_1(\partial M; \mathbb{Z}^{n-1}). \end{aligned}$$

The factorization of δ is constructed in the next section (see Proposition 8.5), and the factorization of γ thus follows from Proposition 7.5. By Proposition 7.8, we thus have

$$\gamma' \circ \delta' = \mathrm{id} \otimes A_{\mathfrak{g}}.$$

Since $\det(A_g) = n$, it follows that γ' maps onto a subgroup of $H_1(\partial M; \mathbb{Z}^{n-1})$ of index h^n , where $h = \frac{1}{2} \text{rank}(H_1(\partial M))$. This shows that δ' induces an isomorphism

$$H_1(\partial M; \mathbb{Z}[1/n]^{n-1}) \longrightarrow H_3(\mathcal{J}^g) \otimes \mathbb{Z}[1/n]$$

with inverse $(\text{id} \otimes A_g^{-1}) \circ \gamma'$. The fact that Ω corresponds to the form ω_{A_g} in (2.11) follows from

$$\begin{aligned} \omega_{A_g}(\alpha \otimes v, \beta \otimes w) &= \omega(\lambda \otimes v, \mu \otimes Aw) \\ &= \omega(\lambda \otimes v, \gamma' \circ \delta'(\mu \otimes w)) \\ &= \Omega(\delta'(\lambda \otimes v), \delta'(\mu \otimes w)), \end{aligned} \tag{7.6}$$

where λ and μ are in $H_1(\partial M)$, and v and w in \mathbb{Z}^{n-1} .

8. Cusp equations and rank

We express the cusp equations in terms of yet another decomposition of ∂M . This decomposition was introduced in Garoufalidis, Goerner, and Zickert [12], and is the induced decomposition on ∂M induced by the decomposition of M obtained by truncating both vertices and edges. We call it the *doubly truncated decomposition* and denote it by $\mathcal{T}_{\partial M}^\circ$ (see Figure 35). As in [12], we label the edges by γ^{ijk} and β^{ijk} . The superscript ijk of an edge indicates the initial vertex (denoted by v^{ijk}) of the edge, i being the nearest vertex of Δ , ij , the nearest edge and ijk the nearest face. As in Section 7.1.1, we label the hexagonal faces by τ^i and the polygonal faces by $p^{\{i_l, j_l\}}$ (see Figure 36).

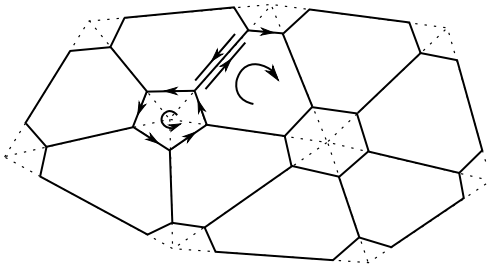

Figure 35. Doubly truncated decomposition of ∂M .

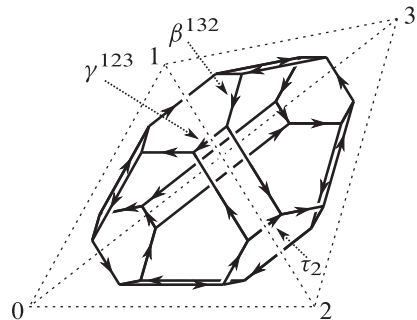

Figure 36. Labeling conventions.

8.1. Cusp equations. For a shape assignment z consider the map

$$\begin{aligned}
 C(z): C_1(\mathcal{T}_{\partial M}^{\square}; \mathbb{Z}^{n-1}) &\longrightarrow \mathbb{C}^*, \\
 \gamma^{ijk} \otimes e_r &\longmapsto (z_{(r-1)v_i + (n-r-1)v_j}^{\varepsilon_{ij}})^{-\varepsilon_{\mathcal{U}}^{ijk}}, \\
 \beta^{ijk} \otimes e_r &\longmapsto \prod_{\substack{t \in \text{face}(ijk) \\ t_i=r}} (X_t)^{\varepsilon_{\mathcal{U}}^{ijk}},
 \end{aligned} \tag{8.1}$$

where $\varepsilon_{\mathcal{U}}^{ijk}$ is the sign of the permutation taking $ijkl$ to 0123 , and the X_t 's are X -coordinates (Definition 3.7). It follows from [12, Section 13] that $C(z)$ is a cocycle (it is the ratio of consecutive diagonal entries in the *natural cocycle* [12] associated to z). Hence, $C(z)$ may be regarded as a cohomology class $C(z) \in H^1(\partial M; (\mathbb{C}^*)^{n-1})$. This class vanishes if and only if for each generator λ of $H_1(\partial M)$, we have

$$C(z)(\lambda \otimes e_r) = 1. \tag{8.2}$$

We refer to (8.2) as the *cuspidal equation* for $\lambda \otimes e_r$. The above discussion is summarized in the result below.

Theorem 8.1 (Garoufalidis, Goerner, and Zickert [12]). *The $\mathrm{PGL}(n, \mathbb{C})$ -representation determined by a shape assignment z is boundary-unipotent if and only if all cuspidal equations are satisfied. Equivalently, if and only if $C(z)$ is trivial in $H^1(\partial M; (\mathbb{C}^*)^{n-1})$.*

By (8.1), the cuspidal equation for $\lambda \otimes e_r$ can be written in the form

$$\prod_{s, \Delta} z_{s, \Delta}^{A_{\lambda \otimes e_r, (s, \Delta)}^{\text{cusp}}} \prod_{s, \Delta} (1 - z_{s, \Delta})^{B_{\lambda \otimes e_r, (s, \Delta)}^{\text{cusp}}} = \pm 1.$$

8.2. Linearizing the cuspidal equations. Let

$$\begin{aligned}
 v_0 &= (1, 0, 0, 0), & v_1 &= (0, 1, 0, 0), \\
 v_2 &= (0, 0, 1, 0), & v_3 &= (0, 0, 0, 1)
 \end{aligned}$$

be the vertices of Δ_1^3 , and consider the map

$$\begin{aligned}
 \delta': C_1(\mathcal{T}_{\partial M}^{\square}; \mathbb{Z}^{n-1}) &\longrightarrow J^{\mathfrak{g}}(\mathcal{T}), \\
 \gamma^{ijk} \otimes e_r &\longmapsto -\varepsilon_{\mathcal{U}}^{ijk} ((r-1)rv_i + (n-r-1)v_j, \varepsilon_{ij}), \\
 \beta^{ijk} \otimes e_r &\longmapsto \varepsilon_{\mathcal{U}}^{ijk} \sum_{\substack{t \in \text{face}(ijk) \\ t_i=r}} \sum_{s+e=t} (s, e)
 \end{aligned}$$

We may think of δ' as a linear version of (8.1). We wish to prove that δ' induces a map in homology.

Lemma 8.2. *Let $\mathring{\Delta}_n^3(\mathbb{Z}) \subset \Delta_n^3(\mathbb{Z})$ denote the interior points. For each $r = 1, \dots, n - 1$, we have*

$$\sum_{t \in \mathring{\Delta}_n^3(\mathbb{Z}), t_i=r} \beta(t) = - \sum_{t \in \partial \Delta_n^3(\mathbb{Z}), t_i=r} \sum_{s+e=t} (s, e). \tag{8.3}$$

Proof. Consider a slice of $\Delta_n^3(\mathbb{Z})$ consisting of integral points with $t_i = r$ as shown in Figure 37 for $n - r = 4$. Each dot represents an integral point t and each vertex of each triangle intersecting t represents an edge e of a subsimplex s with $s + e = t$. By (4.1) and (4.2) the sum of the vertices (regarded as pairs (s, e)) of each triangle is zero. Using this it easily follows that the sum of all interior edges equals minus the sum of the boundary edges. Figure 37 shows the proof for $n - r = 4$. □

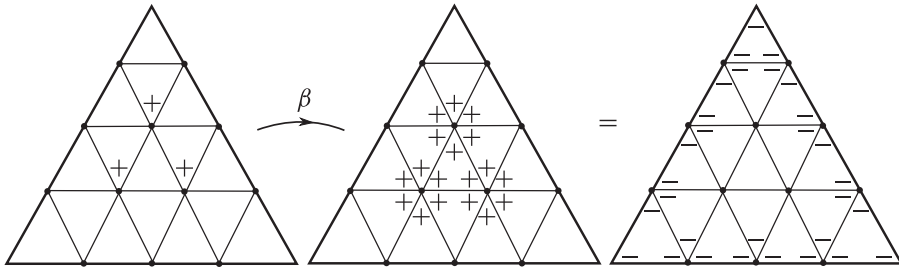

Figure 37. Proof of Lemma 8.2 for $n - r = 4$.

Proposition 8.3. *The map δ' induces a map on homology.*

Proof. We wish to extend δ' to a commutative diagram

$$\begin{CD} C_2(\mathcal{T}_{\partial M}^\square; \mathbb{Z}^{n-1}) @>\partial>> C_1(\mathcal{T}_{\partial M}^\square; \mathbb{Z}^{n-1}) @>\partial>> C_0(\mathcal{T}_{\partial M}^\square; \mathbb{Z}^{n-1}) \\ @V\delta'_2VV @VV\delta'V @VV\delta'_0V \\ C_1^g(\mathcal{T}) @>\beta>> J^g(\mathcal{T}) @>\beta^*>> C_1^g(\mathcal{T}). \end{CD}$$

Define

$$\begin{aligned} \delta'_2: C_2(\mathcal{T}_{\partial M}^\square; \mathbb{Z}^{n-1}) &\longrightarrow C_1^g(\mathcal{T}), \\ \tau^i \otimes e_r &\longmapsto - \sum_{t \in \mathring{\Delta}_n^3(\mathbb{Z}), t_i=r} [t], \\ p^{\{i_l j_l\}} &\longmapsto \sum_l [(r v_{i_l} + (n - r) v_{j_l}, \Delta_l)], \end{aligned}$$

and

$$\begin{aligned} \delta'_0: C_0(\mathcal{T}_{\partial M}^{\square}; \mathbb{Z}^{n-1}) &\longrightarrow C_1^{\mathfrak{g}}(\mathcal{T}), \\ v^{ijk} \otimes e_r &\longmapsto [(r+1)v_i + (n-r-1)v_j] \\ &\quad - [rv_i + (n-r)v_j] \\ &\quad + [(r-1)v_i + v_k + (n-r)v_j] \\ &\quad - [rv_i + v_k + (n-r-1)v_j]. \end{aligned}$$

The fact that $\beta \circ \delta'_2(p^{iijl}) \otimes e_r = \delta' \circ \partial(p^{iijl}) \otimes e_r$ is immediate, and the fact that $\beta \circ \delta'_2(\tau^i \otimes e_r) = \delta' \circ \partial(\tau^i \otimes e_r)$ follows from Lemma 8.2. The terms involved in $\delta'_0 \circ \partial(\beta^{ijk} \otimes e_r)$ are the ones involved in a long hexagon relation, and exactly correspond to the terms in $\beta^* \circ \delta'(\beta^{ijk} \otimes e_r)$, which are a sum of hexagon relations. Finally, the equality $\beta^* \circ \delta'(\gamma^{ijk} \otimes e_r) = \delta'_0 \circ \partial(\gamma^{ijk} \otimes e_r)$ follows from the fact that the four edge terms of $\delta'_0 \circ \partial(\gamma^{ijk} \otimes e_r)$ cancel out, and the remaining 4 terms are exactly those of $\beta^* \circ \delta'(\gamma^{ijk} \otimes e_r)$. \square

Let z be a shape assignment on \mathcal{T} . Since $z_{s,\Delta}^{1100} z_{s,\Delta}^{0110} z_{s,\Delta}^{1010} = -1$ for each subsimplex s of each simplex Δ of \mathcal{T} , it follows that z defines an element $z \in \mathrm{Hom}(J^{\mathfrak{g}}(\mathcal{T}); \mathbb{C}^*/\{\pm 1\})$, and since the gluing equations are satisfied, we obtain an element $z \in H^3(\mathcal{J}^{\mathfrak{g}}; \mathbb{C}^*/\{\pm 1\})$.

Dual to δ' we have $\delta'^*: H^3(\mathcal{J}^{\mathfrak{g}}; \mathbb{C}^*) \rightarrow H^1(\partial M; (\mathbb{C}^*)^{n-1})$. The following follows immediately from the definitions.

Proposition 8.4. *We have $\delta'^*(z) = C(z) \in H^1(\partial M; (\mathbb{C}^*/\{\pm 1\})^{n-1})$.*

In particular, δ'^* is given by

$$\begin{aligned} \delta'^*(z): H_1(M; \mathbb{Z}^{n-1}) &\longrightarrow \mathbb{C}^*/\{\pm 1\}, \\ \lambda \otimes e_r &\longmapsto \prod_{(s,\Delta)} z_{s,\Delta}^{A_{\lambda,(s,\Delta)}} \prod_{(s,\Delta)} (1 - z_{s,\Delta})^{B_{\lambda,(s,\Delta)}}. \end{aligned}$$

For any abelian group A , we shall use the canonical identifications

$$\mathrm{Hom}(H_1(\partial M; \mathbb{Z}^{n-1}), A) \cong (\mathrm{Hom}(H_1(\partial M), A))^{n-1} \cong H^1(\partial M; A^{n-1}).$$

If ϕ is an element of $\mathrm{Hom}(H_1(\partial M; \mathbb{Z}^{n-1}), A)$ or $H^1(\partial M; A^{n-1})$, we let

$$\phi_r: H_1(\partial M) \longrightarrow A$$

denote the r th coordinate function.

Proposition 8.5. *We have*

$$\delta = \delta' \circ (\mathrm{id} \otimes D) \in \mathrm{Hom}(H_1(\partial M; \mathbb{Z}^{n-1}), H_3(\mathcal{J}^{\mathfrak{g}})),$$

$$D = \mathrm{diag}(n-1, n-2, \dots, 1).$$

Equivalently, the coordinate functions of δ and δ' satisfy $\delta_r = (n-r)\delta'_r$.

Proof. We prove the second statement. Every class in $H_1(\partial M)$ can be represented by a curve λ which is a sequence of left and right turns as shown in Figure 38. We can represent λ in $C_1(\mathcal{T}_{\partial M}^{\diamond})$ and $C_1(\mathcal{T}_{\partial M}^{\square})$ as follows: The representation in $C_1(\mathcal{T}_{\partial M}^{\diamond})$ is the natural one, and the representation in $C_1(\mathcal{T}_{\partial M}^{\square})$ is obtained by replacing a left turn by a γ edge, and a right turn by a concatenation of 3 edges of type β , γ and β (see Figure 39). The contribution to $\delta'_r(\lambda)$ and $\delta_r(\lambda)$ from a left and right turn are shown schematically in Figures 40 and 41 (the interior points are ignored, c.f. Remark 7.3). Each dot represents an integral point t , contributing the terms $\sum_{s+e=t}(s, e)$. We wish to prove that $\delta_r(\lambda) = (n - r)\delta'_r(\lambda)$, whenever λ is a cycle. This can be seen by inspecting Figures 42 and 43. Namely, the figures show that if we consider two consecutive turns, the terms involved in the difference $\delta(\lambda \otimes e_r) - (n - r)\delta'(\lambda \otimes e_r)$ lie entirely on the faces containing the starting point and the ending point, respectively. The fact that the middle terms cancel out follows from the fact that when two faces are paired, the terms on each side differ by an element in the image of β . \square

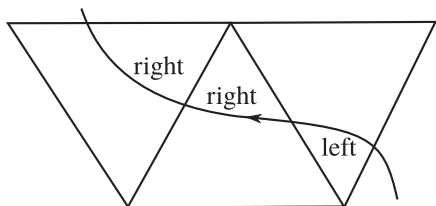

Figure 38. Left and right turns.

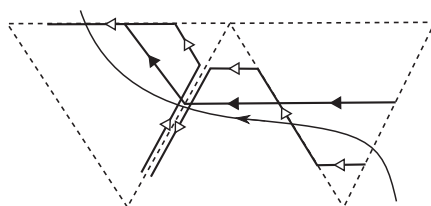

Figure 39. Representing a curve in $C_1(\mathcal{T}_{\partial M}^{\diamond})$ and $C_1(\mathcal{T}_{\partial M}^{\square})$.

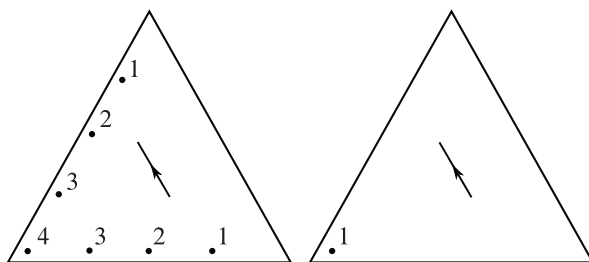

Figure 40. δ and δ' for a left turn.

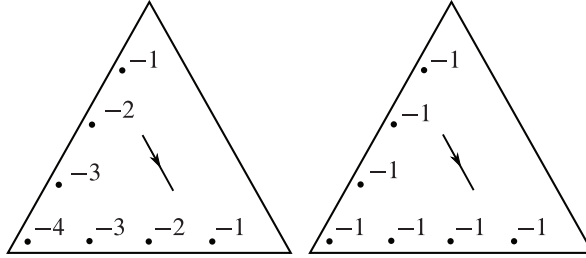

Figure 41. δ and δ' for a right turn.

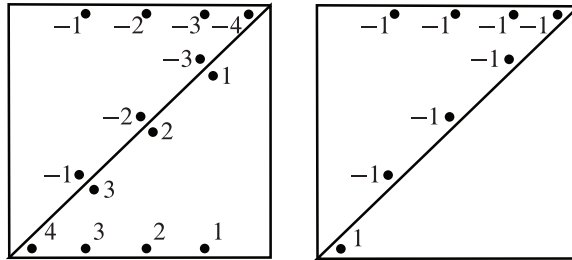

Figure 42. δ and δ' for a left turn followed by a right turn.

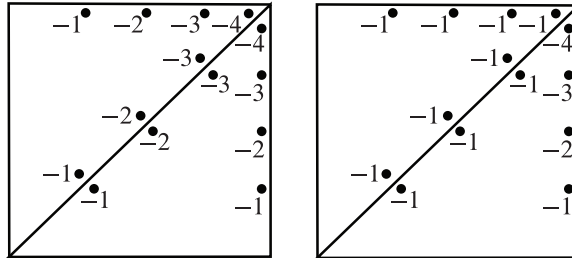

Figure 43. δ and δ' for two right turns.

8.3. Proof of Corollaries 2.11 and 2.12. By comparing the generalized gluing equation (3.1) with the definition (4.3) of β we obtain that

$$\beta(p) = \sum_{(s,\Delta)} A_{p,(s,\Delta)}(s, \varepsilon_{01})_{\Delta} + \sum_{(s,\Delta)} B_{p,(s,\Delta)}(s, \varepsilon_{12})_{\Delta}. \quad (8.4)$$

Also, by definition of δ' , we have

$$\delta'(p) = \sum_{(s,\Delta)} A_{\lambda \otimes e_r, (s,\Delta)}^{\text{cusp}}(s, \varepsilon_{01})_{\Delta} + \sum_{(s,\Delta)} B_{\lambda \otimes e_r, (s,\Delta)}^{\text{cusp}}(s, \varepsilon_{12})_{\Delta}, \quad (8.5)$$

and is in $\text{Ker}(\beta^*)$. Since $\beta^* \circ \beta = 0$, $\text{Ker}(\beta^*)$ is orthogonal to $\text{Im}(\beta)$ proving the first statement of Corollary 2.11. The second statement follows from (7.6). Finally, Corollary 2.12 follows immediately from the fact that $H_4(\mathcal{J}^{\mathfrak{g}})$ is zero modulo torsion.

Acknowledgment. The authors wish to thank Matthias Goerner and Walter Neumann for useful conversations. We also thank the referees for providing many helpful comments.

References

- [1] A. Berenstein, S. Fomin, and A. Zelevinsky, Cluster algebras. III. Upper bounds and double Bruhat cells. *Duke Math. J.* **126** (2005), no. 1, 1–52. [MR 2110627](#) [Zbl 1135.16013](#)
- [2] N. Bergeron, E. Falbel, and A. Guilloux, Tetrahedra of flags, volume and homology of $\text{SL}(3)$. *Geom. Topol.* **18** (2014), no. 4, 1911–1971. [MR 3268771](#) [Zbl 06356603](#)
- [3] F. Bonahon and H. Wong, The Witten–Reshetikhin–Turaev representation of the Kauffman skein algebra. *Proc. Am. Math. Soc.* **144** (2016), no. 6, 2711–2724. [Zbl 06560797](#)
- [4] T. Dimofte, Quantum Riemann surfaces in Chern–Simons theory. *Adv. Theor. Math. Phys.* **17** (2013), no. 3, 479–599. [MR 3250765](#) [Zbl 1304.81143](#)
- [5] T. Dimofte, M. Gabella, and A. B. Goncharov, K -decompositions and 3d gauge theories. Preprint 2013. [arXiv:1301.0192](#) [hep-th]
- [6] T. Dimofte, D. Gaiotto, and S. Gukov, 3-manifolds and 3d indices. *Adv. Theor. Math. Phys.* **17** (2013), no. 5, 975–1076. [MR 3262519](#) [Zbl 1297.81149](#)
- [7] T. Dimofte, D. Gaiotto, and S. Gukov, Gauge theories labelled by three-manifolds. *Comm. Math. Phys.* **325** (2014), no. 2, 367–419. [MR 3148093](#) [Zbl 1292.57012](#)
- [8] T. Dimofte and S. Garoufalidis, The quantum content of the gluing equations. *Geom. Topol.* **17** (2013), no. 3, 1253–1315. [MR 3073925](#) [Zbl 1283.57017](#)
- [9] T. Dimofte, S. Gukov, J. Lenells, and D. Zagier, Exact results for perturbative Chern–Simons theory with complex gauge group. *Commun. Number Theory Phys.* **3** (2009), no. 2, 363–443. [MR 2551896](#) [Zbl 1214.81151](#)
- [10] V. Fock and A. Goncharov, Moduli spaces of local systems and higher Teichmüller theory. *Publ. Math. Inst. Hautes Études Sci.* **103** (2006), 1–211. [MR 2233852](#) [Zbl 1099.14025](#)
- [11] S. Garoufalidis, The 3D index of an ideal triangulation and angle structures. *Ramanujan J.* **40** (2016), no. 3, 573–604. [MR 3522084](#)
- [12] S. Garoufalidis, M. Goerner, and C. K. Zickert, Gluing equations for $\text{PGL}(n, \mathbb{C})$ -representations of 3-manifolds. *Algebr. Geom. Topol.* **15** (2015), no. 1, 565–622. [MR 3325748](#) [Zbl 06425414](#)

- [13] S. Garoufalidis, C. D. Hodgson, H. Rubinstein, and H. Segerman, 1-efficient triangulations and the index of a cusped hyperbolic 3-manifold. *Geom. Topol.* **19** (2015), no. 5, 2619–2689. [MR 3416111](#) [Zbl 1330.57029](#)
- [14] S. Garoufalidis, D. P. Thurston, and C. K. Zickert, The complex volume of $\mathrm{SL}(n, \mathbb{C})$ -representations of 3-manifolds. *Duke Math. J.* **164** (2015), no. 11, 2099–2160. [MR 3385130](#) [Zbl 06486372](#)
- [15] A. Guilloux, Representations of 3-manifold groups in $\mathrm{PGL}(n, 3)$ and their restriction to the boundary. Preprint 2013. [arXiv:1310.2907](#) [math.GT]
- [16] B. Keller, Cluster algebras and derived categories. In Y. Kawamata (eds.), *Derived categories in algebraic geometry*. Proceedings of the conference held at the University of Tokyo, Tokyo, January 2011. EMS Series of Congress Reports. European Mathematical Society (EMS), Zürich, 2012, 123–183. [MR 3050703](#) [MR 3052795](#) (collection) [Zbl 1299.13027](#) [Zbl 1256.14001](#) (collection)
- [17] W. D. Neumann, Combinatorics of triangulations and the Chern–Simons invariant for hyperbolic 3-manifolds. In B. Apanasov, W. D. Neumann, A. W. Reid and L. Siebenmann (eds.) *Topology '90*. Papers from the Research Semester in Low-dimensional Topology held at Ohio State University, Columbus, Ohio, February–June 1990. Ohio State University Mathematical Research Institute Publications, 1. Walter de Gruyter & Co., Berlin, 1992, 243–271. [MR 1184415](#) [MR 1184397](#) (collection) [Zbl 0768.57006](#) [Zbl 0747.00024](#) (collection)
- [18] W. D. Neumann and D. Zagier, Volumes of hyperbolic three-manifolds. *Topology* **24** (1985), no. 3, 307–332. [MR 0815482](#) [Zbl 0589.57015](#)
- [19] W. P. Thurston, *The geometry and topology of three-manifolds*. Princeton lecture notes, 1980. <http://library.msri.org/books/gt3m/PDF/1.pdf>

Received October 9, 2013

Stavros Garoufalidis, School of Mathematics, Georgia Institute of Technology,
Atlanta, GA 30332-0160, USA

e-mail: stavros@math.gatech.edu

Christian K. Zickert, Department of Mathematics, University of Maryland,
College Park, MD 20742-4015, USA

e-mail: zickert@math.umd.edu