

The Kontsevich integral for bottom tangles in handlebodies

Kazuo Habiro and Gwénaél Massuyeau

Abstract. Using an extension of the Kontsevich integral to tangles in handlebodies similar to a construction given by Andersen, Mattes and Reshetikhin, we construct a functor $Z: \mathcal{B} \rightarrow \hat{\mathbf{A}}$, where \mathcal{B} is the category of bottom tangles in handlebodies and $\hat{\mathbf{A}}$ is the degree-completion of the category \mathbf{A} of Jacobi diagrams in handlebodies. As a symmetric monoidal linear category, \mathbf{A} is the linear PROP governing “Casimir Hopf algebras”, which are cocommutative Hopf algebras equipped with a primitive invariant symmetric 2-tensor. The functor Z induces a canonical isomorphism $\text{gr } \mathcal{B} \cong \mathbf{A}$, where $\text{gr } \mathcal{B}$ is the associated graded of the Vassiliev–Goussarov filtration on \mathcal{B} . To each Drinfeld associator φ we associate a ribbon quasi-Hopf algebra H_φ in $\hat{\mathbf{A}}$, and we prove that the braided Hopf algebra resulting from H_φ by “transmutation” is precisely the image by Z of a canonical Hopf algebra in the braided category \mathcal{B} . Finally, we explain how Z refines the LMO functor, which is a TQFT-like functor extending the Le–Murakami–Ohtsuki invariant.

Mathematics Subject Classification (2010). 57K16, 57K20, 57K31, 16T05, 18M05, 18M15.

Keywords. 3-manifold, bottom tangle, cobordism, Kontsevich integral, LMO invariant, finite type invariant, TQFT, Drinfeld associator, Hopf algebra, quasi-triangular quasi-Hopf algebra, braided monoidal category, symmetric monoidal category.

Contents

1	Introduction	2
2	The category \mathcal{B} of bottom tangles in handlebodies	14
3	Review of the Kontsevich integral	17
4	The category \mathbf{A} of Jacobi diagrams in handlebodies	25
5	Presentation of the category \mathbf{A}	40
6	A ribbon quasi-Hopf algebra in $\hat{\mathbf{A}}$	56
7	Weight systems	62
8	Construction of the functor Z	63

9	The braided monoidal functor Z_q^φ and computation of Z	72
10	Universality of the extended Kontsevich integral	83
11	Relationship with the LMO functor	91
12	Perspectives	102
	References	106

1. Introduction

1.1. Background. The *Kontsevich integral* is a powerful knot invariant, taking values in the space of *chord diagrams* or *Jacobi diagrams*, which are univalent graphs encoding Lie-algebraic structures [37, 4]. It is universal among rational-valued Vassiliev–Goussarov finite type invariants [62, 19], and dominates various quantum link invariants such as the colored Jones polynomials. Le and Murakami [39] and Bar-Natan [6] extended the Kontsevich integral to a functor

$$Z^{\mathcal{J}}: \mathcal{T}_q \longrightarrow \mathcal{A}$$

from the category \mathcal{T}_q of framed oriented q -tangles to the category \mathcal{A} of Jacobi diagrams. The Kontsevich integral was generalized to links and tangles in thickened surfaces by Andersen, Mattes and Reshetikhin [3] and by Lieberum [42].

Le, Murakami and Ohtsuki [41] constructed a closed 3-manifold invariant by using the Kontsevich integral. After attempts of extending the Le–Murakami–Ohtsuki (LMO) invariant to TQFTs by Murakami and Ohtsuki [51] and by Cheptea and Le [10], Cheptea and the authors [9] constructed a functor

$$\tilde{Z}: \mathcal{LCob}_q \longrightarrow {}^{\text{ts}}\mathcal{A},$$

called the *LMO functor*. Here ${}^{\text{ts}}\mathcal{A}$ is the category of *top-substantial Jacobi diagrams* and \mathcal{LCob}_q is the “non-strictification” of the braided strict monoidal category \mathcal{LCob} of *Lagrangian cobordisms*. The category \mathcal{LCob} is a subcategory of the category \mathcal{Cob} of cobordisms between once-punctured surfaces, studied by Crane and Yetter [11] and Kerler [34]. The LMO functor gives representations of the monoids of homology cylinders and, in particular, the Torelli groups, which were studied in [26, 49]. (Other representations of the monoids of homology cylinders have also been derived from the LMO invariant by Andersen, Bene, Meilhan and Penner [1].)

1.2. The category \mathcal{B} of bottom tangles in handlebodies. We consider here the *category \mathcal{B} of bottom tangles in handlebodies* [22], which we may regard as a

braided monoidal subcategory of \mathcal{LCob} [9]. The objects of \mathcal{B} are non-negative integers. For $m \geq 0$, let $V_m \subset \mathbb{R}^3$ denote the cube with m handles:

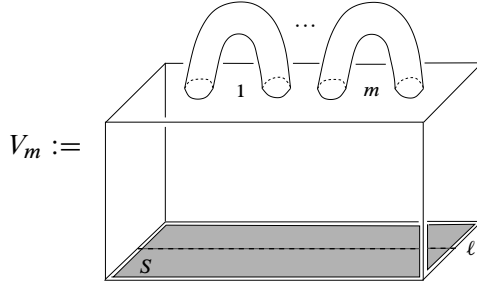

The morphisms from m to n in \mathcal{B} are the isotopy classes of n -component *bottom tangles* in V_m , which are framed tangles, each consisting of n arc components whose endpoints are placed on a “bottom line” $\ell \subset \partial V_m$, in such a way that the two endpoints of each component are adjacent on ℓ . Here are an example of a bottom tangle and its projection diagram, for $m = 2$ and $n = 3$:

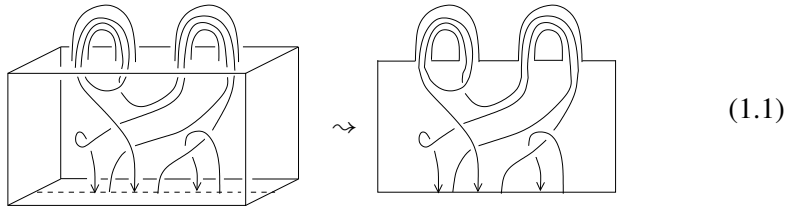

As another example, observe that $\mathcal{B}(0, 1)$ is essentially the set of knots in \mathbb{R}^3 . We associate to each $T: m \rightarrow n$ in \mathcal{B} an embedding $i_T: V_n \hookrightarrow V_m$ which fixes the “bottom square” S and identifies V_n with a regular neighborhood in V_m of the union of S with the n components of T . Then the composition of $m \xrightarrow{T} n \xrightarrow{T'} p$ in \mathcal{B} is represented by the image $i_T(T') \subset V_m$. (See Section 2 for further details.)

We can also define composition in \mathcal{B} using “cube presentations” of bottom tangles. Each morphism T in \mathcal{B} is represented by a bottom tangle which can be decomposed into a tangle U , called a *cube presentation* of T , and parallel families of cores of the 1-handles of the handlebody. For instance, the bottom tangle (1.1) has the following cube presentation:

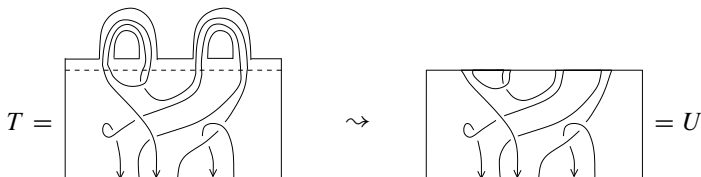

We can define the composition $T' \circ T$ of two morphisms T and T' in \mathcal{B} as the bottom tangle obtained by putting a suitable cabling of T on the top of a cube presentation of T' . For example,

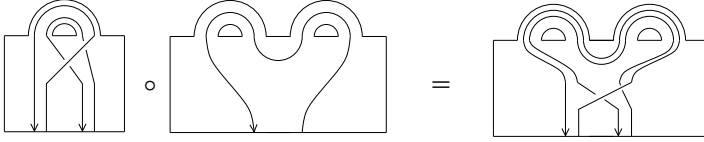

We may identify \mathcal{B} with the opposite \mathcal{H}^{op} of the category \mathcal{H} of isotopy classes of embeddings of handlebodies rel S , via the above correspondence $T \mapsto i_T$. The category \mathcal{B} is also isomorphic to the *category ${}^{\mathcal{S}}\mathcal{L}\text{Cob}$ of special Lagrangian cobordisms* introduced in [9]: each bottom tangle $T: m \rightarrow n$ in \mathcal{B} corresponds to the cobordism obtained as the exterior of the embedding $i_T: V_n \hookrightarrow V_m$. The category ${}^{\mathcal{S}}\mathcal{L}\text{Cob}$, and hence \mathcal{B} , inherit from $\mathcal{L}\text{Cob} \subset \text{Cob}$ a braided strict monoidal structure. In \mathcal{B} , tensor product on objects is addition and tensor product on morphisms is juxtaposition; the braiding $\psi = \psi_{1,1}: 2 \rightarrow 2$, which determines all braidings in \mathcal{B} , is

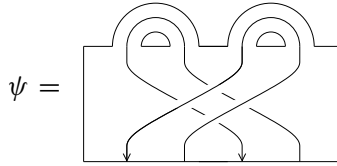

The first author [22] (see also forthcoming [25]) introduced the category \mathcal{B} in order to study universal quantum invariants of links and tangles [28, 38, 58, 53, 32] unifying the Reshetikhin–Turaev quantum invariants associated with each ribbon Hopf algebra [12, 59]. Indeed, for each ribbon Hopf algebra H , there is a braided monoidal functor

$$J^H: \mathcal{B} \longrightarrow \mathbf{Mod}_H \quad (1.2)$$

extending the universal quantum link invariant to bottom tangles in handlebodies, where \mathbf{Mod}_H denotes the category of left H -modules.

The category \mathcal{B} admits a Hopf algebra object $H^{\mathcal{B}}$, whose counterpart in Cob was introduced by Crane and Yetter [11] and Kerler [34]. This Hopf algebra structure in \mathcal{B} and Cob may be identified with the Hopf-algebraic structure for claspers observed in [21] (see [22, 25]). The braided monoidal category \mathcal{B} is generated by the Hopf algebra $H^{\mathcal{B}}$ together with a few other morphisms (see Section 9.1). *Transmutation* introduced by Majid [46, 47] is a process of transforming each quasi-triangular Hopf algebra H into a braided Hopf algebra \underline{H} in \mathbf{Mod}_H . The functor J^H maps the Hopf algebra $H^{\mathcal{B}}$ in \mathcal{B} to the transmutation \underline{H} of H .

In the present paper, using the Kontsevich integral $Z^{\mathcal{J}}$, we construct and study a functor

$$Z_q^\varphi: \mathcal{B}_q \longrightarrow \hat{\mathbf{A}}_q^\varphi,$$

which is a refinement of the LMO functor \tilde{Z} on the category $\mathcal{B} \cong {}^s\mathcal{L}Cob \subset \mathcal{L}Cob$, and which may be considered as a ‘‘Kontsevich integral version’’ of the functor J^H in (1.2). The target category $\hat{\mathbf{A}}_q^\varphi$ of Z_q^φ is constructed from the category \mathbf{A} of Jacobi diagrams in handlebodies, described below. (See Section 4 for further details.)

1.3. The category \mathbf{A} of Jacobi diagrams in handlebodies. We work over a fixed field \mathbb{K} of characteristic 0. For $m \geq 0$, let \bar{V}_m denote the square with m handles, which is constructed by attaching m 1-handles on the top of a square and can be regarded as the image of the handlebody V_m under the projection $\mathbb{R}^3 \twoheadrightarrow \mathbb{R}^2$. Let $X_n := \bigcap_1 \cdots \bigcap_n$ be the 1-manifold consisting of n arc components.

The objects in \mathbf{A} are non-negative integers. The morphisms from m to n in \mathbf{A} are linear combinations of (m, n) -Jacobi diagrams, which are Jacobi diagrams on X_n mapped into \bar{V}_m . Specifically, an (m, n) -Jacobi diagram D consists of

- a univalent graph D such that each trivalent vertex is oriented, and such that the set of univalent vertices is embedded into the interior of X_n ,
- a map $X_n \cup D \rightarrow \bar{V}_m$ that maps ∂X_n into the ‘‘bottom edge’’ of \bar{V}_m in a way similar to how the endpoints of a bottom tangle are mapped into the bottom line of a handlebody.

Here is an example of a $(2, 3)$ -Jacobi diagram:

$$D = \begin{array}{c} \text{[Diagram of a (2,3)-Jacobi diagram D in a handlebody } \bar{V}_2 \text{ with 3 univalent vertices]} \end{array} : 2 \longrightarrow 3. \tag{1.3}$$

As usual, the Jacobi diagrams obey the STU relations

$$\begin{array}{c} \text{[STU relation diagram: a vertex with three univalent edges meeting at a central vertex]} \\ \longrightarrow \end{array} = \begin{array}{c} \text{[STU relation diagram: a vertex with three univalent edges meeting at a central vertex]} \\ \longrightarrow \end{array} - \begin{array}{c} \text{[STU relation diagram: a vertex with three univalent edges meeting at a central vertex]} \\ \longrightarrow \end{array}.$$

Moreover, we identify Jacobi diagrams that are homotopic in \bar{V}_m relative to the endpoints of X_n . Since V_m deformation retracts to \bar{V}_m , we could equivalently give the same definitions with \bar{V}_m replaced by V_m . Thus the diagrams of the above kind are also referred to as *Jacobi diagrams in handlebodies*.

A *square presentation* of an (m, n) -Jacobi diagram D is a usual Jacobi diagram U (i.e., a morphism in the target category \mathcal{A} of the Kontsevich integral $Z^{\mathcal{J}}$) which yields D by attaching parallel copies of cores of the 1-handles in \bar{V}_m . For example, here is a square presentation of D in (1.3):

$$U = \boxed{\begin{array}{c} \text{Diagram with 3 vertical strands and various crossings and arcs} \end{array}} \quad (1.4)$$

Although *not* every (m, n) -Jacobi diagram admits a square presentation, the STU relation implies that every morphism $m \rightarrow n$ in \mathbf{A} is a linear combination of such diagrams admitting square presentations.

Composition in \mathbf{A} is defined by using square presentations, similarly to how composition in \mathcal{B} is defined by using cube presentations. For $l \xrightarrow{D'} m \xrightarrow{D} n$ in \mathbf{A} and a square presentation U of D , the composition $D \circ D' : l \rightarrow n$ is the stacking of a suitable cabling $C_U(D')$ on the top of U . Here the *cabling* $C_U(D')$ is obtained from D' by replacing each component of X_m with its parallel copies so that the target of $C_U(D')$ matches the source of U ; we also replace each univalent vertex attached to a component of X_m with the sum of all ways of attaching it (with signs) to the parallel copies of this component. For example, if $D : 2 \rightarrow 3$ and U are as in (1.3) and (1.4), respectively, and if

$$D' = \boxed{\begin{array}{c} \text{Diagram with 2 strands and crossings} \end{array}} : 2 \rightarrow 2,$$

then we have

$$D \circ D' = \boxed{\begin{array}{c} \text{Stacked diagram with 2 strands on top and 3 on bottom} \end{array}} : 2 \rightarrow 3.$$

(Here we use “boxes” to denote the above-mentioned operation on univalent vertices; this notation is explained in Example 3.2.)

The category \mathbf{A} has a structure of a linear symmetric strict monoidal category. Tensor product on objects is addition, and tensor product on morphisms is juxtaposition. The symmetry in \mathbf{A} is determined by

$$P = P_{1,1} = \begin{array}{c} \text{Diagram of two crossings with handles} \\ \text{in a rectangular box with two handles on top} \end{array} : 2 \longrightarrow 2.$$

Moreover, the morphism spaces $\mathbf{A}(m, n)$ are graded with the usual degree of Jacobi diagrams (i.e., half the number of vertices), and their degree completions $\hat{\mathbf{A}}(m, n)$ form a linear category $\hat{\mathbf{A}}$, called the *degree-completion* of \mathbf{A} .

We remark that Jacobi diagrams in surfaces, such as squares with handles, were considered earlier in the above-mentioned works [3, 42]. In Section 4, we will define $\mathbf{A}(m, n)$ in a rather different way as a space of *colored* Jacobi diagrams. The latter are essentially the same as (m, n) -Jacobi diagrams, i.e., Jacobi diagrams on X_n mapped into $\bar{V}_m \simeq V_m$, but the maps in $\bar{V}_m \simeq V_m$ are specified by decorating the components of X_n and the dashed part of the diagram with some *beads*. These beads are labeled by elements of

$$\pi_1(\bar{V}_m) \cong \pi_1(V_m) = F(x_1, \dots, x_m) =: F_m,$$

the free group on the elements x_1, \dots, x_m corresponding to the 1-handles of V_m . Colored Jacobi diagrams appeared in [17, 18] for instance.

1.4. Construction of a functor $Z^{\mathcal{B}}$. The *non-strictification* \mathcal{C}_q of a strict monoidal category \mathcal{C} (whose object monoid is free) is the non-strict monoidal category obtained from \mathcal{C} by forcing the tensor product to be not strictly associative but associative up to canonical isomorphisms; see Section 3.3 for the definition. For example, the category \mathcal{T}_q of q -tangles, which is the source category of the Kontsevich integral $Z^{\mathcal{T}}$, is the non-strictification of the strict monoidal category \mathcal{T} of tangles. The object set $\text{Ob}(\mathcal{T})$ of \mathcal{T} is the free monoid $\text{Mon}(\pm)$ on two letters $+, -$ corresponding to downward and upward strings; correspondingly, the set $\text{Ob}(\mathcal{T}_q)$ is the free unital magma $\text{Mag}(\pm)$ on $+, -$, consisting of fully-parenthesized words in $+, -$ such as $+, -, (-+), -(++)$, including the empty word \emptyset .

Non-strictification is applied to strict monoidal categories such as \mathcal{B} and $\hat{\mathbf{A}}$ to produce non-strict monoidal categories \mathcal{B}_q and $\hat{\mathbf{A}}_q$. Since $\text{Ob}(\mathcal{B}) = \text{Ob}(\hat{\mathbf{A}}) = \{0, 1, \dots\}$ can be identified with $\text{Mon}(\bullet)$, the free monoid on one letter \bullet , we may set $\text{Ob}(\mathcal{B}_q) = \text{Ob}(\hat{\mathbf{A}}_q) = \text{Mag}(\bullet)$, the free unital magma on \bullet . The latter consists of

parenthesized words in \bullet such as $\emptyset, \bullet, (\bullet\bullet), ((\bullet\bullet)\bullet)$. The length of $w \in \text{Mag}(\bullet)$ is denoted by $|w|$. The morphisms in \mathcal{B}_q are called *bottom q -tangles in handlebodies*.

Recall that a Drinfeld associator $\varphi = \varphi(X, Y)$ is a group-like element of $\mathbb{K}\langle\langle X, Y \rangle\rangle$ satisfying the so-called *pentagon* and *hexagon* equations [14]; see Section 6.2. Here is the main construction of the present paper.

Theorem 1.1 (see Theorem 9.3). *For each Drinfeld associator φ , there is a braided monoidal functor*

$$Z^\varphi_q: \mathcal{B}_q \longrightarrow \widehat{\mathbf{A}}^\varphi_q \tag{1.5}$$

from \mathcal{B}_q , the non-strictification of the category \mathcal{B} , to $\widehat{\mathbf{A}}^\varphi_q$, a “deformation” of the non-strictification of $\widehat{\mathbf{A}}$ which is determined by φ .

To prove Theorem 1.1, we will construct a tensor-preserving functor

$$Z^\mathcal{B}: \mathcal{B}_q \longrightarrow \widehat{\mathbf{A}}. \tag{1.6}$$

If we ignore the monoidal structures, the categories $\widehat{\mathbf{A}}^\varphi_q$ and $\widehat{\mathbf{A}}$ are equivalent in a natural way and, under this equivalence, the functors Z^φ_q and $Z^\mathcal{B}$ are essentially the same for each φ . We construct the functor $Z^\mathcal{B}$ by using the usual Kontsevich integral $Z^\mathcal{T}: \mathcal{T}_q \rightarrow \mathcal{A}$ as follows. Here $Z^\mathcal{T}$ is defined from the Drinfeld associator φ , using the normalization

$$\begin{aligned} Z^\mathcal{T} \left(\begin{array}{c} \curvearrowright \\ (+-) \end{array} \right) &= \begin{array}{c} \textcircled{1} \\ \curvearrowright \end{array} : \emptyset \longrightarrow (+-) \text{ in } \mathcal{A}, \\ Z^\mathcal{T} \left(\begin{array}{c} (+-) \\ \curvearrowleft \end{array} \right) &= \begin{array}{c} \curvearrowleft \\ \textcircled{\nu} \end{array} : (+-) \longrightarrow \emptyset \text{ in } \mathcal{A}, \end{aligned}$$

where ν is the usual normalization factor. (In the literature, one often uses the normalization with both 1 and ν in the above identities being replaced with $\nu^{1/2}$, so that the invariant behaves well under π -rotation of tangles. In our case, like in [9], it is more important to have a simple value on $\curvearrowleft \curvearrowright$.)

Consider $T: v \rightarrow w$ in \mathcal{B}_q with $|v| = m$ and $|w| = n$. In order to define $Z^\mathcal{B}(T)$, we choose a projection diagram of T

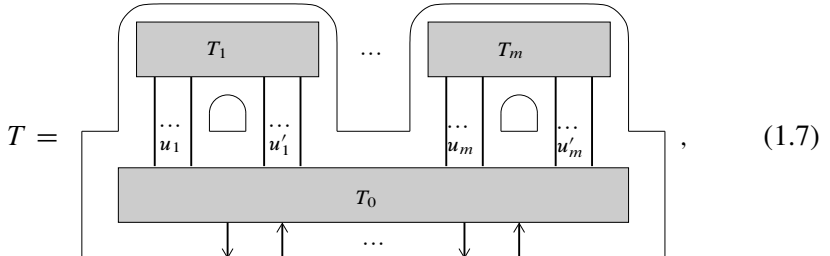

composed of q -tangles

$$T_0: \tilde{v} \longrightarrow w(+ -), \quad T_i: \emptyset \longrightarrow u_i u'_i \quad (i = 1, \dots, m),$$

where

- $u_1, u'_1, \dots, u_m, u'_m \in \text{Mag}(\pm)$,
- $\tilde{v} := v(u_1 u'_1, \dots, u_m u'_m)$ is obtained from the non-associative word v in \bullet by substituting $u_1 u'_1, \dots, u_m u'_m$ into the m \bullet 's, and $w(+ -) := w(+ -, \dots, + -)$ is defined similarly.

Then we define $Z^{\mathcal{B}}(T): m \rightarrow n$ in $\hat{\mathbf{A}}$ by

$$Z^{\mathcal{B}}(T) = \begin{array}{c} \begin{array}{c} \text{---} Z^{\mathcal{T}}(T_1) \text{---} \dots \text{---} Z^{\mathcal{T}}(T_m) \text{---} \\ \uparrow \quad \uparrow \quad \uparrow \quad \uparrow \quad \uparrow \quad \uparrow \\ \dots \quad u_1 \quad \text{---} \quad u'_1 \quad \dots \quad \dots \quad u_m \quad \text{---} \quad u'_m \quad \dots \\ \uparrow \quad \uparrow \quad \uparrow \quad \uparrow \quad \uparrow \quad \uparrow \\ \text{---} Z^{\mathcal{T}}(T_0) \text{---} \\ \downarrow \quad \downarrow \quad \downarrow \quad \downarrow \quad \downarrow \quad \downarrow \end{array} \end{array} \cdot \quad (1.8)$$

We remark that the above definition of $Z^{\mathcal{B}}(T)$, simply as an invariant of tangles in handlebodies, is similar to the definition of the Kontsevich integral of links in thickened surfaces given by Andersen, Mattes and Reshetikhin [3]; see also Lieberum [42].

Theorem 1.2 (see Theorem 8.2). *There is a functor $Z^{\mathcal{B}}: \mathcal{B}_q \rightarrow \hat{\mathbf{A}}$ such that*

- on objects $w \in \text{Mag}(\bullet)$, we have $Z^{\mathcal{B}}(w) = |w|$,
- on morphisms $T: v \rightarrow w$ in \mathcal{B}_q decomposed as (1.7), we have (1.8).

Furthermore, the functor $Z^{\mathcal{B}}$ is tensor-preserving, i.e.,

$$Z^{\mathcal{B}}(T \otimes T') = Z^{\mathcal{B}}(T) \otimes Z^{\mathcal{B}}(T')$$

for morphisms T and T' in \mathcal{B}_q .

The functor $Z^{\mathcal{B}}$ is *not* monoidal since it does not preserve the associativity isomorphisms. The braided monoidal category $\hat{\mathbf{A}}_q^{\varphi}$ mentioned in Theorem 1.1 is constructed from the non-strictification $\hat{\mathbf{A}}_q$ of $\hat{\mathbf{A}}$ by redefining the associativity isomorphisms and braidings to be the images by $Z^{\mathcal{B}}$ of those of \mathcal{B}_q . Then Theorem 1.1 follows from Theorem 1.2.

1.5. Basic properties of $Z^{\mathcal{B}}$. Here are some basic properties of $Z^{\mathcal{B}}$.

The functor $Z^{\mathcal{B}}$ extends the usual Kontsevich integral for bottom q -tangles in a cube, i.e., for each $T: \emptyset \rightarrow w$ in \mathcal{B}_q , regarded also as $T: \emptyset \rightarrow w(+)$ in \mathcal{T}_q , we have $Z^{\mathcal{B}}(T) = Z^{\mathcal{T}}(T)$.

We can enrich \mathbf{A} and $\widehat{\mathbf{A}}$ over cocommutative coalgebras, i.e., the morphism spaces in \mathbf{A} and $\widehat{\mathbf{A}}$ have cocommutative coalgebra structures, and the compositions and tensor products on them are coalgebra maps (see Proposition 4.15). It follows that $Z^{\mathcal{B}}$ takes values in the group-like part of $\widehat{\mathbf{A}}$ (see Proposition 8.7).

Let \mathbf{F} denote the category of finitely generated free groups. Consider the functor

$$h: \mathcal{B} \cong \mathcal{H}^{\text{op}} \longrightarrow \mathbf{F}^{\text{op}}$$

that maps each bottom tangle $T: m \rightarrow n$ to the homomorphism $(i_T)_*: F_n \rightarrow F_m$ between free groups. This functor gives an \mathbf{F}^{op} -grading of the category \mathcal{B} . Similarly, we have an \mathbf{F}^{op} -grading of the linear category \mathbf{A} and its completion $\widehat{\mathbf{A}}$, where the \mathbf{F}^{op} -degree of each (m, n) -Jacobi diagram D is the homotopy class of the underlying map $X_n \rightarrow \bar{V}_m$. It follows that $Z^{\mathcal{B}}$ preserves \mathbf{F}^{op} -grading (see Proposition 8.8).

The degree 0 part of $Z^{\mathcal{B}}(T)$, which belongs to $\mathbf{A}_0 \cong \mathbb{K}\mathbf{F}^{\text{op}}$, is given by the homotopy class $h(T)$ of the components of T in the handlebody. The degree 1 part of $Z^{\mathcal{B}}(T)$, which we do not study in the present paper, is given by equivariant linking numbers of the components of T in the handlebody. We give the values of $Z^{\mathcal{B}}$ up to degree 2 on the generators of the monoidal category \mathcal{B}_q (see Proposition 9.7).

1.6. $Z^{\mathcal{B}}$ as a universal finite type invariant. The main property of the invariant $Z^{\mathcal{B}}$ is the universality among Vassiliev–Goussarov finite type invariants, formulated functorially. Similarly to the case of usual tangles in a cube [31], we define the *Vassiliev–Goussarov filtration*

$$\mathbb{K}\mathcal{B}_q = \mathcal{V}^0 \supset \mathcal{V}^1 \supset \mathcal{V}^2 \supset \dots$$

on the linearization $\mathbb{K}\mathcal{B}_q$ of the non-strict monoidal category \mathcal{B}_q , and we consider the same filtration on the linear strict monoidal category $\mathbb{K}\mathcal{B}$. The braiding in \mathcal{B} induces a symmetry in the associated graded $\text{Gr } \mathbb{K}\mathcal{B}$ of $\mathbb{K}\mathcal{B}$. We give $\widehat{\mathbf{A}}_q^\varphi$ the degree filtration.

Theorem 1.3 (see Theorem 10.7 and Theorem 10.8). *The functor $Z_q^\varphi: \widehat{\mathbb{K}\mathcal{B}_q} \rightarrow \widehat{\mathbf{A}}_q^\varphi$ is an isomorphism of filtered linear braided monoidal categories. Consequently, $Z^{\mathcal{B}}$ induces an isomorphism $\text{Gr } \mathbb{K}\mathcal{B} \cong \mathbf{A}$ of graded linear symmetric monoidal categories.*

It is hoped that Vassiliev–Goussarov invariants distinguish knots in S^3 [62]; since the usual Kontsevich integral is universal among such invariants, the hope is that the functor $Z^{\mathcal{T}}$ is faithful. More generally, we expect the following.

Conjecture 1.4. *The functor $Z^{\mathcal{B}}$ (resp. Z_q^{ϕ}) is faithful. In other words, $Z^{\mathcal{B}}$ (resp. Z_q^{ϕ}) is a complete invariant of bottom tangles in handlebodies.*

1.7. The functor $Z^{\mathcal{B}}$ as a refinement of the LMO functor. The functor $Z^{\mathcal{B}}$ refines the LMO functor \tilde{Z} in the following way.

Theorem 1.5 (see Theorem 11.2 and Remark 11.3). *We have a commutative diagram of functors:*

$$\begin{array}{ccc} \mathcal{B}_q & \xrightarrow{Z^{\mathcal{B}}} & \hat{\mathbf{A}} \\ E \downarrow & & \downarrow \kappa \\ \mathcal{L}Cob_q & \xrightarrow{\tilde{Z}} & {}^{\text{ts}}\mathcal{A} \end{array} \quad (1.9)$$

Here the functor $E: \mathcal{B}_q \rightarrow \mathcal{L}Cob_q$, with the image being ${}^{\mathcal{S}}\mathcal{L}Cob_q$, is the faithful functor that maps each bottom tangle in a handlebody to its exterior viewed as a Lagrangian cobordism. The linear functor $\kappa: \hat{\mathbf{A}} \rightarrow {}^{\text{ts}}\mathcal{A}$ is a variant of the “hair map” defined in [16, 18], and we may also regard it as a diagrammatic enhancement of the “Magnus expansion”:

$$F_m \hookrightarrow \mathbb{K}\langle\langle X_1, \dots, X_m \rangle\rangle, \quad x_i \longmapsto \exp(X_i) = 1 + X_i + \frac{X_i^2}{2!} + \dots .$$

Theorem 1.6 (see Theorem 11.6). *The “hair functor” $\kappa: \hat{\mathbf{A}} \rightarrow {}^{\text{ts}}\mathcal{A}$ is not faithful. In fact, if $m, n \geq 1$, then the map $\kappa: \hat{\mathbf{A}}(m, n) \rightarrow {}^{\text{ts}}\mathcal{A}(m, n)$ is not injective.*

Thus the functor $Z^{\mathcal{B}}$ properly refines the restriction of the LMO functor \tilde{Z} to ${}^{\mathcal{S}}\mathcal{L}Cob$. We prove the above theorem by adapting Patureau–Mirand’s proof [55] of the non-injectivity of the “hair map”, which itself uses Vogel’s results [63]. The authors do not know whether $Z^{\mathcal{B}}$ is strictly stronger than \tilde{Z} as an invariant of bottom tangles in handlebodies. In fact, we conjecture that the LMO functor $\tilde{Z}: \mathcal{L}Cob_q \rightarrow {}^{\text{ts}}\mathcal{A}$ itself is faithful.

Recall that the construction of the LMO functor \tilde{Z} involves surgery presentations of Lagrangian cobordisms. Here surgery translates into the *Aarhus integral*, which Bar-Natan, Garoufalidis, Rozansky and Thurston [7] introduced in their reconstruction of the LMO invariant. The construction of the functor $Z^{\mathcal{B}}$ in the present paper is simpler than that of \tilde{Z} since it does not involve these surgery techniques.

1.8. Presentation of \mathbf{A} . The category \mathbf{F} of finitely generated free groups is a symmetric monoidal category, and it is well known that it is freely generated as such by a commutative Hopf algebra [56]. By generalizing another combinatorial proof of this fact given in [24], we obtain the following presentation of \mathbf{A} .

Theorem 1.7 (see Theorem 5.11). *The linear symmetric strict monoidal category \mathbf{A} is freely generated by a “Casimir Hopf algebra”.*

In other words, \mathbf{A} is the linear PROP (see [45, 48]) governing Casimir Hopf algebras. Here a *Casimir Hopf algebra* in a linear symmetric monoidal category $\mathcal{C} = (\mathcal{C}, \otimes, I)$ is a cocommutative Hopf algebra H in \mathcal{C} equipped with a *Casimir 2-tensor*, i.e., a morphism $c: I \rightarrow H \otimes H$ which is *primitive*, *symmetric* and *ad-invariant*. (See Definition 5.1.) The Casimir Hopf algebra (H, c) in \mathbf{A} alluded to in Theorem 1.7 is defined in (5.28).

To illustrate this kind of structure, consider a Lie algebra \mathfrak{g} with an ad-invariant, symmetric element $t \in \mathfrak{g}^{\otimes 2}$. Then the universal enveloping algebra $U(\mathfrak{g})$ together with $t \in \mathfrak{g}^{\otimes 2} \subset U(\mathfrak{g})^{\otimes 2}$ is a Casimir Hopf algebra in the category $\mathbf{Vect}_{\mathbb{K}}$ of \mathbb{K} -vector spaces. Thus, by Theorem 1.7, there is a unique linear symmetric monoidal functor

$$W_{(\mathfrak{g}, t)}: \mathbf{A} \longrightarrow \mathbf{Vect}_{\mathbb{K}}$$

which maps the Casimir Hopf algebra (H, c) in \mathbf{A} to the Casimir Hopf algebra $(U(\mathfrak{g}), t)$. Following the usual terminology, we call $W_{(\mathfrak{g}, t)}$ the *weight system* associated to the pair (\mathfrak{g}, t) .

1.9. Ribbon quasi-Hopf algebras in $\widehat{\mathbf{A}}$. Recall that a *quasi-Hopf algebra* H [13] (see also [30]) is a variant of a Hopf algebra, where coassociativity does not hold strictly, but is controlled by a 3-tensor $\varphi \in H^{\otimes 3}$; see Section 6.1 for the definition. The notions of quasi-triangular and ribbon Hopf algebras, used in the construction of quantum link invariants [59], admit quasi-Hopf versions, using which one can construct link invariants as well [2]. One can also consider quasi-Hopf algebras in symmetric monoidal categories.

As is well known, if t is an ad-invariant, symmetric 2-tensor for a Lie algebra \mathfrak{g} as above, then each Drinfeld associator $\varphi \in \mathbb{K}\langle\langle X, Y \rangle\rangle$ induces a ribbon quasi-Hopf algebra structure on $U(\mathfrak{g})[[\hbar]]$. Here is a universal version of this fact.

Theorem 1.8 (see Theorem 6.2). *For each Drinfeld associator φ , the Casimir Hopf algebra (H, c) in \mathbf{A} induces a canonical ribbon quasi-Hopf algebra H_{φ} in $\widehat{\mathbf{A}}$.*

Specifically, the weight system $W_{(\mathfrak{g}, t)}$ associated to the above pair (\mathfrak{g}, t) maps H_{φ} to the quasi-triangular quasi-Hopf structure on $U(\mathfrak{g})[[\hbar]]$ considered in [14].

Klim [36] generalized Majid’s transmutation to quasi-Hopf algebras. We can perform transmutation in arbitrary symmetric monoidal categories. In particular, by transmutation, the quasi-triangular quasi-Hopf algebra H_φ yields a Hopf algebra \underline{H}_φ in the braided monoidal category \mathbf{Mod}_{H_φ} of left H_φ -modules in $\hat{\mathbf{A}}$. On the other hand, by Theorem 1.1, the Hopf algebra $H^{\mathcal{B}_q}$ in \mathcal{B}_q (corresponding to the Hopf algebra $H^{\mathcal{B}}$ in \mathcal{B}) is mapped by the braided monoidal functor $Z_q^\varphi: \mathcal{B}_q \rightarrow \hat{\mathbf{A}}_q^\varphi$ into a Hopf algebra $Z_q^\varphi(H^{\mathcal{B}_q})$ in $\hat{\mathbf{A}}_q^\varphi$.

Theorem 1.9 (see Theorem 9.6). *The Hopf algebra $Z_q^\varphi(H^{\mathcal{B}_q})$ in $\hat{\mathbf{A}}_q^\varphi$ and the transmutation \underline{H}_φ in \mathbf{Mod}_{H_φ} coincide, through a canonical embedding $\hat{\mathbf{A}}_q^\varphi \rightarrow \mathbf{Mod}_{H_\varphi}$.*

To prove Theorem 1.9, we compute the values of Z_q^φ on a generating system of \mathcal{B}_q including the structure morphisms of $H^{\mathcal{B}_q}$; see Proposition 9.2.

1.10. Organization of the paper. We organize the rest of the paper as follows. In Section 2, we define the categories \mathcal{B} , \mathcal{H} and ${}^s\mathcal{L}Cob$. In Section 3, we recall the definition of the usual Kontsevich integral $Z := Z^{\mathcal{T}}$. In Section 4, we define the category \mathbf{A} of Jacobi diagrams in handlebodies and we start studying its algebraic structure. In Section 5, we go further in this study by giving a presentation of \mathbf{A} as a linear symmetric monoidal category. In Section 6, we show that each Drinfeld associator $\varphi = \varphi(X, Y)$ yields a ribbon quasi-Hopf algebra H_φ in the degree-completion $\hat{\mathbf{A}}$ of \mathbf{A} and, in Section 7, we consider the weight system functors on \mathbf{A} associated to Lie algebras with symmetric ad-invariant 2-tensors. The construction of the functor $Z := Z^{\mathcal{B}}: \mathcal{B}_q \rightarrow \hat{\mathbf{A}}$ is done in Section 8, where we also give some of its basic properties. In Section 9, we define the braided monoidal functor $Z_q^\varphi: \mathcal{B}_q \rightarrow \hat{\mathbf{A}}_q^\varphi$: thanks to this variant of $Z^{\mathcal{B}}$, we interpret the values of $Z^{\mathcal{B}}$ on a generating system of \mathcal{B}_q as the result of applying Majid’s transmutation to the ribbon quasi-Hopf algebra H_φ . In Section 10, we show that Z_q^φ induces an isomorphism of braided monoidal categories between the completion of $\mathbb{K}\mathcal{B}_q$ with respect to the Vassiliev–Goussarov filtration and $\hat{\mathbf{A}}_q^\varphi$. In Section 11, we explain how the functor $Z^{\mathcal{B}}: \mathcal{B}_q \rightarrow \hat{\mathbf{A}}$ refines the LMO functor $\tilde{Z}: \mathcal{L}Cob_q \rightarrow {}^t\mathcal{A}$. Finally, in Section 12, we explain some applications that we expect from our results.

1.11. Conventions. In what follows, we fix a field \mathbb{K} of characteristic 0. By a “vector space” (resp. a “linear map”), we always mean a “ \mathbb{K} -vector space” (resp. a “ \mathbb{K} -linear map”).

Let $\mathbb{N} = \{0, 1, 2, \dots\}$ be the set of non-negative integers. The unit interval is denoted by $I := [-1, 1] \subset \mathbb{R}$, and we denote by $(\vec{x}, \vec{y}, \vec{z})$ the usual frame of \mathbb{R}^3 given by $\vec{x} = (1, 0, 0)$, $\vec{y} = (0, 1, 0)$, $\vec{z} = (0, 0, 1)$.

By a ‘‘monoidal functor’’ between (strict or non-strict) monoidal categories, we always mean a *strict* monoidal functor.

Acknowledgments. The work of K. Habiro is partly supported by JSPS KAKENHI Grant Number 15K04873; the work of G. Massuyeau is supported in part by the project ITIQ-3D, funded by the ‘‘Région Bourgogne Franche-Comté.’’ The authors are grateful to Mai Katada and Jean-Baptiste Meilhan for helpful comments on the previous versions of the manuscript.

2. The category \mathcal{B} of bottom tangles in handlebodies

In this section, we define three strict monoidal categories

- \mathcal{B} of bottom tangles in handlebodies [22],
- \mathcal{H} of embeddings of handlebodies [23],
- ${}^s\mathcal{L}Cob$ of special Lagrangian cobordisms [9],

with the same object monoid $\text{Ob}(\mathcal{B}) = \text{Ob}(\mathcal{H}) = \text{Ob}({}^s\mathcal{L}Cob) = \mathbb{N}$. They are essentially the same structures since we have isomorphisms of strict monoidal categories

$$\mathcal{B} \cong \mathcal{H}^{\text{op}} \cong {}^s\mathcal{L}Cob.$$

The categories \mathcal{B} and \mathcal{H} will be studied in more detail in [25].

Let m, n, p be non-negative integers throughout this section.

2.1. Bottom tangles in handlebodies. Let $V_m \subset \mathbb{R}^3$ denote the handlebody of genus m that is obtained from the cube $I^3 \subset \mathbb{R}^3$ by attaching m handles on the top square $I^2 \times \{1\}$:

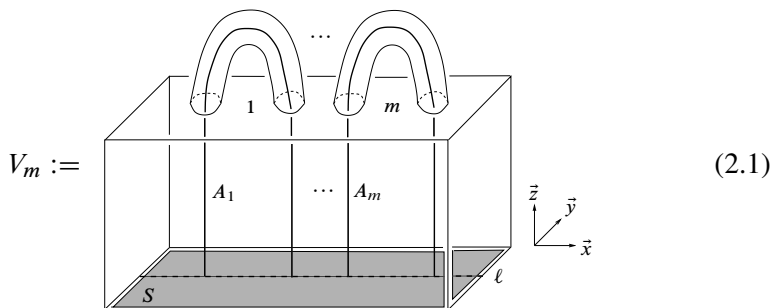

We call $S := I^2 \times \{-1\}$ the *bottom square* of V_m and $\ell := I \times \{0\} \times \{-1\}$ the *bottom line* of V_m . Let A_1, \dots, A_m denote the arcs obtained from the cores of the handles by “stretching” the ends down to ℓ .

An n -component *bottom tangle* $T = T_1 \cup \dots \cup T_n$ in V_m is a framed, oriented tangle consisting of n arc components T_1, \dots, T_n such that

- (1) the endpoints of T are uniformly distributed along ℓ ,
- (2) for $i = 1, \dots, n$, the i -th component T_i runs from the $2i$ -th endpoint to the $(2i - 1)$ -st endpoint, where we count the endpoints of T from the left.

We usually depict bottom tangles by drawing their orthogonal projections onto the plane $\mathbb{R} \times \{1\} \times \mathbb{R}$ and assuming the *blackboard framing convention*; i.e., the framing is given by the vector field \vec{y} . For example, here is a 3-component bottom tangle in V_2 together with a projection diagram:

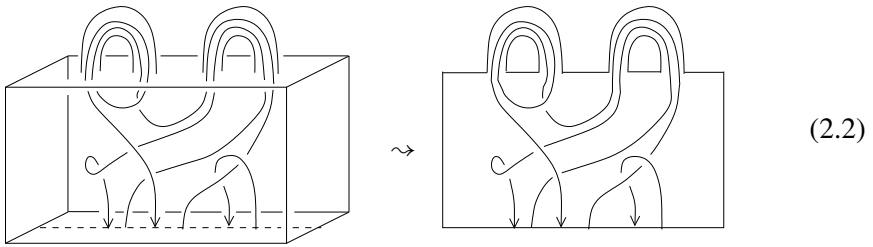

2.2. The category \mathcal{B} of bottom tangles in handlebodies. Morphisms from m to n in \mathcal{B} are isotopy classes of n -component bottom tangles in V_m . Define the composition of two bottom tangles $m \xrightarrow{T} n \xrightarrow{T'} p$ by

$$T' \circ T = i_T(T'): m \longrightarrow p,$$

where

$$i_T: V_n \hookrightarrow V_m$$

is an embedding which maps $S \subset V_n$ identically onto $S \subset V_m$ and maps A_i onto T_i in a framing-preserving way for all $i = 1, \dots, n$. Here is an example of the composition of morphisms $2 \rightarrow 1 \rightarrow 2$:

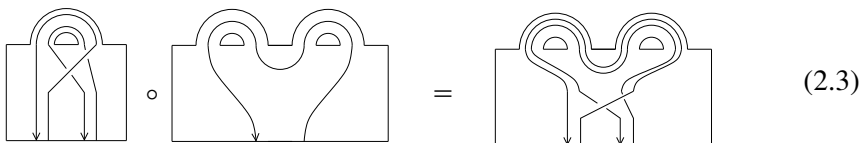

the obvious boundary parametrization) defines a cobordism from $\Sigma_{m,1}$ to $\Sigma_{0,1}$. More generally, every n -component bottom tangle $T \subset V_m$ defines a cobordism

$$E_T := (E_T, e_T)$$

from $\Sigma_{m,1}$ to $\Sigma_{n,1}$ by considering the exterior E_T of T in V_m , together with the boundary parametrization e_T induced by the framing of T .

Define the category \mathcal{Cob} of 3-dimensional cobordisms introduced by Crane and Yetter [11] and Kerler [34] as follows. Set $\text{Ob}(\mathcal{Cob}) = \mathbb{N}$. Morphisms from m to n in \mathcal{Cob} are equivalence classes of cobordisms from $\Sigma_{m,1}$ to $\Sigma_{n,1}$. We obtain the composition $C' \circ C: m \rightarrow p$ of $C' = (C', c'): n \rightarrow p$ and $C = (C, c): m \rightarrow n$ from C' and C by identifying the target surface of C with the source surface of C' using the boundary parametrizations. The identity morphism $\text{id}_m: m \rightarrow m$ is the cylinder $\Sigma_{m,1} \times I$ with the boundary parametrization defined by the identity maps.

We equip \mathcal{Cob} with a strict monoidal structure such that $m \otimes m' = m + m'$, and we obtain the tensor product $C \otimes C'$ of $C = (C, c)$ and $C' = (C', c')$ from C and C' by identifying the right square $c(\{1\} \times I \times I)$ of ∂C with the left square $c'(\{-1\} \times I \times I)$ of $\partial C'$.

A cobordism C from $\Sigma_{m,1}$ to $\Sigma_{n,1}$ is said to be *special Lagrangian* if we have

$$V_n \circ C = V_m: m \longrightarrow 0.$$

The special Lagrangian cobordisms form a monoidal subcategory ${}^s\mathcal{L}\mathcal{Cob}$ of \mathcal{Cob} . We have an isomorphism $\mathcal{B} \cong {}^s\mathcal{L}\mathcal{Cob}$ of strict monoidal categories given by

$$\begin{aligned} \mathcal{B}(m, n) &\xrightarrow{\cong} {}^s\mathcal{L}\mathcal{Cob}(m, n), \\ (T \subset V_m) &\longmapsto E_T, \\ (A \subset (V_n \circ C)) &\longleftarrow C. \end{aligned}$$

3. Review of the Kontsevich integral

In this section, we briefly review the combinatorial construction of the Kontsevich integral of tangles in the cube. See [6, 39, 31, 54] for further details.

3.1. Free monoids and magmas. For a finite set $\{s_1, \dots, s_r\}$, let $\text{Mon}(s_1, \dots, s_r)$ denote the free monoid on s_1, \dots, s_r , consisting of words in the letters s_1, \dots, s_r . For $w \in \text{Mon}(s_1, \dots, s_r)$, let $|w|$ denote the length of w , and $w_1, \dots, w_{|w|}$ the consecutive letters in w .

Let also $\text{Mag}(s_1, \dots, s_r)$ denote the free unital magma on s_1, \dots, s_r , consisting of non-associative words in s_1, \dots, s_r . Let

$$U: \text{Mag}(s_1, \dots, s_r) \longrightarrow \text{Mon}(s_1, \dots, s_r)$$

be the (surjective) map forgetting parentheses. Sometimes the word $U(w)$ for $w \in \text{Mag}(s_1, \dots, s_r)$ will be simply denoted by w .

3.2. The category \mathcal{T} of tangles in the cube. By a *tangle* in the cube I^3 we mean a framed, oriented tangle γ in I^3 , whose boundary points are on the intervals $I \times \{0\} \times \{-1, 1\}$. We assume that the framing at each endpoint is the vector \vec{y} . In figures we use the blackboard framing convention as before.

The *source* $s(\gamma) \in \text{Mon}(\pm) := \text{Mon}(+, -)$ of a tangle γ is the word in $+$ and $-$ that are read along the oriented interval $I \times \{0\} \times \{+1\}$, where each boundary point of γ is given the sign $+$ (resp. $-$) when the orientation of γ at that point is downwards (resp. upwards). The *target* $t(\gamma) \in \text{Mon}(\pm)$ of γ is defined similarly. The tangle γ is said to be *from* $s(\gamma)$ *to* $t(\gamma)$.

We define the strict monoidal *category \mathcal{T} of tangles* (in the cube) as follows. Set $\text{Ob}(\mathcal{T}) = \text{Mon}(\pm)$. Morphisms from w to w' in \mathcal{T} are the isotopy classes of tangles from w to w' . We obtain the composition $\gamma \circ \gamma'$ of two tangles γ and γ' such that $t(\gamma') = s(\gamma)$ by gluing γ' on the top of γ . The identity $\text{id}_w: w \rightarrow w$ of $w \in \text{Ob}(\mathcal{T})$ is the trivial tangle with straight vertical components. The tensor product in the strict monoidal category \mathcal{T} is juxtaposition.

3.3. The category \mathcal{T}_q of q -tangles in the cube. Here we define the category \mathcal{T}_q of q -tangles in the cube as the “non-strictification” of the strict monoidal category \mathcal{T} . Since we use this construction also for other categories, we first give a general definition.

Let \mathcal{C} be a strict monoidal category such that the object monoid $\text{Ob}(\mathcal{C})$ is a free monoid $\text{Mon}(S)$ on a set S . Then the *non-strictification* of \mathcal{C} is the (non-strict) monoidal category \mathcal{C}_q defined as follows. Set $\text{Ob}(\mathcal{C}_q) = \text{Mag}(S)$, the free unital magma on S . Let $U: \text{Mag}(S) \rightarrow \text{Mon}(S)$ be the canonical map, forgetting parentheses. Set $\mathcal{C}_q(x, y) = \mathcal{C}(U(x), U(y))$ for $x, y \in \text{Ob}(\mathcal{C}_q) = \text{Mag}(S)$. The compositions, identities and tensor products in \mathcal{C}_q are given by those of \mathcal{C} . We define the associativity isomorphism by

$$\alpha_{x,y,z} = \text{id}_{x \otimes y \otimes z} \in \mathcal{C}_q((x \otimes y) \otimes z, x \otimes (y \otimes z)) = \mathcal{C}(x \otimes y \otimes z, x \otimes y \otimes z).$$

Note that the tensor product in \mathcal{C}_q is strictly left and right unital, i.e., $\emptyset \otimes x = x = x \otimes \emptyset$ for $x \in \text{Ob}(\mathcal{C}_q)$, where $\emptyset \in \text{Mag}(S)$ is the unit. Then \mathcal{C}_q is a monoidal category, which is not strict if S is not empty. The map $U: \text{Ob}(\mathcal{C}_q) \rightarrow \text{Ob}(\mathcal{C})$ extends to an equivalence of categories

$$U: \mathcal{C}_q \xrightarrow{\cong} \mathcal{C}$$

such that $U(f) = f$ for all $f \in \mathcal{C}_q(x, y) = \mathcal{C}(U(x), U(y))$. If \mathcal{C} is a braided (resp. symmetric) strict monoidal category, then the non-strictification \mathcal{C}_q naturally has the structure of a braided (resp. symmetric) non-strict monoidal category.

Now, define the non-strict braided monoidal *category* \mathcal{T}_q of q -tangles (in the cube) to be the non-strictification of \mathcal{T} . Since $\text{Ob}(\mathcal{T}) = \text{Mon}(\pm)$, we have $\text{Ob}(\mathcal{T}_q) = \text{Mag}(\pm) := \text{Mag}(+, -)$.

3.4. Cabling. Here we review the definition of the ‘‘cabling’’ operations for q -tangles in the cube.

Define the duality involution $w \mapsto w^*$ on $\text{Mag}(\pm)$ inductively by $\emptyset^* = \emptyset$, $\pm^* = \mp$ and $(ww')^* = (w')^*w^*$. For $w \in \text{Mag}(\pm)$ and $f: \{1, \dots, |w|\} \rightarrow \text{Mag}(\pm)$, we obtain $C_f(w) \in \text{Mag}(\pm)$ from w by replacing each of its consecutive letters w_i with the subword $f(i)$ (resp. $f(i)^*$) if $w_i = +$ (resp. $w_i = -$). For every q -tangle $\gamma: w \rightarrow w'$ and every map¹ $f: \pi_0(\gamma) \rightarrow \text{Mag}(\pm)$, let $C_f(\gamma)$ be the q -tangle obtained from γ by replacing each connected component $c \subset \gamma$ with the $f(c)$ -cabling of c . (For instance, if $f(c) = -$, then the $f(c)$ -cabling of c is obtained by reversing the orientation of c and, if $f(c) = (++)$, then the $f(c)$ -cabling of c is obtained by doubling c using the given framing.) We call $C_f(\gamma)$ the f -cabling of γ , and we regard it as a morphism

$$C_f(\gamma): C_{f_s}(w) \longrightarrow C_{f_t}(w')$$

in \mathcal{T}_q . Here $f_s: \{1, \dots, |w|\} \rightarrow \text{Mag}(\pm)$ denotes the composition of f and the map $\{1, \dots, |w|\} \rightarrow \pi_0(\gamma)$ relating the top boundary points of γ to its connected components, and $f_t: \{1, \dots, |w'|\} \rightarrow \text{Mag}(\pm)$ is defined similarly.

One can easily verify the following lemma explaining the behavior of the cabling operation on compositions.

¹ Here the reader is warned that γ should not be thought of as a *morphism* in \mathcal{T}_q , especially if γ has (more than one) closed components. Note that if γ denotes a morphism in \mathcal{T}_q , i.e., an isotopy class of q -tangles, then ‘‘ $\pi_0(\gamma)$ ’’ is not well-defined.

Lemma 3.1. *For q -tangles γ and γ' with $s(\gamma) = t(\gamma')$ and maps $f: \pi_0(\gamma) \rightarrow \text{Mag}(\pm)$ and $f': \pi_0(\gamma') \rightarrow \text{Mag}(\pm)$ with $f_s = f'_t$, we have*

$$C_{f \cup f'}(\gamma \circ \gamma') = C_f(\gamma) \circ C_{f'}(\gamma'), \tag{3.1}$$

where $f \cup f'$ denotes the unique map $\pi_0(\gamma \circ \gamma') \rightarrow \text{Mag}(\pm)$ compatible with f and f' through the canonical maps $\pi_0(\gamma) \rightarrow \pi_0(\gamma \circ \gamma')$ and $\pi_0(\gamma') \rightarrow \pi_0(\gamma \circ \gamma')$.

3.5. Spaces of Jacobi diagrams. Let X be a compact, oriented 1-manifold. A chord diagram D on X is a disjoint union of unoriented arcs, called *chords*, and whose set of endpoints is embedded in the interior of X . We identify two chord diagrams D and D' on X if there is a homeomorphism $(X \cup D, X) \rightarrow (X \cup D', X)$ preserving the orientations and connected components of X . Let $\mathcal{A}(X)$ be the vector space generated by chord diagrams on X modulo the 4T relation:

$$\begin{array}{c} \uparrow \cdots \uparrow \uparrow \cdots \uparrow \uparrow \cdots \uparrow \\ | \cdots | \uparrow \cdots \uparrow \uparrow \cdots \uparrow \\ \uparrow \cdots \uparrow \uparrow \cdots \uparrow \uparrow \cdots \uparrow \\ \uparrow \cdots \uparrow \uparrow \cdots \uparrow \uparrow \cdots \uparrow \end{array} = \begin{array}{c} \uparrow \cdots \uparrow \uparrow \cdots \uparrow \uparrow \cdots \uparrow \\ | \cdots | \uparrow \cdots \uparrow \uparrow \cdots \uparrow \\ \uparrow \cdots \uparrow \uparrow \cdots \uparrow \uparrow \cdots \uparrow \\ \uparrow \cdots \uparrow \uparrow \cdots \uparrow \uparrow \cdots \uparrow \end{array} + \begin{array}{c} \uparrow \cdots \uparrow \uparrow \cdots \uparrow \uparrow \cdots \uparrow \\ | \cdots | \uparrow \cdots \uparrow \uparrow \cdots \uparrow \\ \uparrow \cdots \uparrow \uparrow \cdots \uparrow \uparrow \cdots \uparrow \\ \uparrow \cdots \uparrow \uparrow \cdots \uparrow \uparrow \cdots \uparrow \end{array} \tag{3.2}$$

4T

Here the dashed lines represent chords, and the solid lines are intervals in X with the orientation inherited from X .

Bar-Natan [4] gave an alternative definition of $\mathcal{A}(X)$ as follows. A *Jacobi diagram* D on X is a univalent graph such that each trivalent vertex is oriented (i.e., equipped with a cyclic ordering of the incident half-edges), the set of univalent vertices is embedded in the interior of X , and such that each connected component of D contains at least one univalent vertex. We identify two Jacobi diagrams D and D' on X if there is a homeomorphism $(X \cup D, X) \rightarrow (X \cup D', X)$ preserving the orientations and connected components of X and respecting the vertex-orientations. In pictures, we draw the 1-manifold part X with solid lines, and the graph part D with dashed lines, and the vertex-orientations are counterclockwise. For instance, we can view chord diagrams as Jacobi diagrams without trivalent vertices. The vector space $\mathcal{A}(X)$ is isomorphic to, hence identified with, the vector space generated by Jacobi diagrams on X modulo the STU relation:

$$\begin{array}{c} \text{---} \text{---} \text{---} \\ \diagdown \quad \diagup \\ \text{---} \end{array} \xrightarrow{\text{STU}} \begin{array}{c} \text{---} \text{---} \text{---} \\ | \quad | \quad | \\ \text{---} \end{array} - \begin{array}{c} \text{---} \text{---} \text{---} \\ \diagup \quad \diagdown \\ \text{---} \end{array} \tag{3.3}$$

As proved in [4, Theorem 6], the STU relation implies the AS and IHX relations:

$$\begin{array}{c} \text{---} \text{---} \text{---} \\ \diagdown \quad \diagup \\ \text{---} \end{array} = - \begin{array}{c} \text{---} \text{---} \text{---} \\ \diagup \quad \diagdown \\ \text{---} \end{array} \tag{AS}$$

$$\begin{array}{c} \text{---} \text{---} \text{---} \\ | \quad | \quad | \\ \text{---} \end{array} - \begin{array}{c} \text{---} \text{---} \text{---} \\ | \quad | \quad | \\ \text{---} \end{array} + \begin{array}{c} \text{---} \text{---} \text{---} \\ \diagup \quad \diagdown \\ \text{---} \end{array} = 0 \tag{IHX}$$

Note that $\mathcal{A}(X)$ is a graded vector space, where we define the *degree* of a Jacobi diagram to be half the total number of vertices. Let $\mathcal{A}(X)$ also denote its degree-completion.

Example 3.2. The *box notation* is a useful way to represent certain linear combinations of Jacobi diagrams:

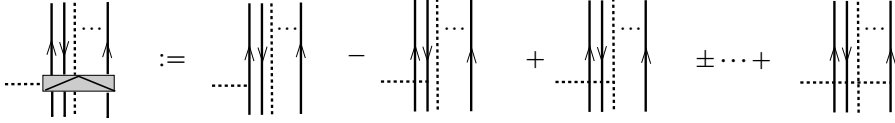

Here, dashed edges and solid arcs are allowed to go through the box, and each of them contributes to one summand in the box notation. A solid arc contributes with a plus or minus sign, depending on the compatibility of its orientation with the direction of the box. A dashed edge always contributes with a plus sign, the orientation of the new trivalent vertex being determined by the direction of the box. We also define

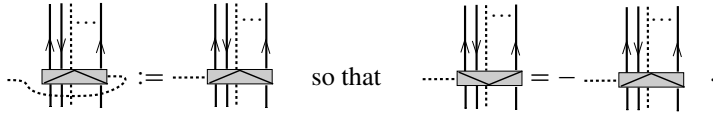

3.6. The category \mathcal{A} of Jacobi diagrams. A compact, oriented 1-manifold X is said to be *polarized* if ∂X is decomposed into a *top part* $\partial_+ X$ and a *bottom part* $\partial_- X$ with each of them totally ordered. The *target* $t(X) \in \text{Mon}(\pm)$ of X is the word obtained from $\partial_- X$ by replacing each positive (resp. negative) point with $+$ (resp. $-$). The *source* $s(X) \in \text{Mon}(\pm)$ of X is defined similarly using $\partial_+ X$, but the rule for the signs $+, -$ is reversed.

Example 3.3. Every q -tangle is naturally regarded as a polarized 1-manifold.

Example 3.4. For $w \in \text{Mon}(\pm)$, let $\downarrow \cdot^w \cdot \downarrow$ denote the identity tangle id_w as a polarized 1-manifold.

We define the *category \mathcal{A} of Jacobi diagrams* as follows. Set $\text{Ob}(\mathcal{A}) = \text{Mon}(\pm)$, and for $w, w' \in \text{Mon}(\pm)$ set

$$\mathcal{A}(w, w') = \coprod_X \mathcal{A}(X)_{\mathfrak{S}_c(X)} \tag{3.5}$$

where X runs over homeomorphism classes of polarized 1-manifolds with $s(X) = w$ and $t(X) = w'$, $c(X)$ is the number of closed components of X , the symmetric group $\mathfrak{S}_{c(X)}$ acts on $\mathcal{A}(X)$ by permutation of closed components and $\mathcal{A}(X)_{\mathfrak{S}_{c(X)}}$ denotes the space of coinvariants. The composition $D \circ D'$ of a Jacobi diagram D on a polarized 1-manifold X with a Jacobi diagram D' on a polarized 1-manifold X' with $s(X) = t(X')$ is the Jacobi diagram $D \sqcup D'$ on $X \cup_{s(X)=t(X')} X'$. The identity id_w of $w \in \text{Ob}(\mathcal{A})$ is the empty Jacobi diagram on $\downarrow \cdot \overset{w}{\cdot} \downarrow$.

The category \mathcal{A} admits a strict monoidal structure such that the tensor product on objects is concatenation of words, and the tensor product on morphisms is juxtaposition of Jacobi diagrams.

Remark 3.5. Note that the category \mathcal{A} is *not* linear, since we can not add up two Jacobi diagrams with the same source and target but with different underlying polarized 1-manifolds. However, by setting

$$\mathcal{A}(w, w') = \bigoplus_X \mathcal{A}(X)_{\mathfrak{S}_{c(X)}}$$

instead of (3.5), we obtain a *linear* strict monoidal category \mathcal{A} . We sometimes need this linear version of \mathcal{A} .

Finally, we have the following analogs of the cabling operations for q -tangles recalled in Section 3.3. We define the *duality* $w \mapsto w^*$ on $\text{Mon}(\pm)$ similarly to that on $\text{Mag}(\pm)$. For $w \in \text{Mon}(\pm)$ and $f: \{1, \dots, |w|\} \rightarrow \text{Mon}(\pm)$, we define $C_f(w)$ as in the non-associative case. For every $D \in \mathcal{A}(X)$ representing a morphism in $\mathcal{A}(w, w')$ with $w, w' \in \text{Mon}(\pm)$ and every map $f: \pi_0(X) \rightarrow \text{Mon}(\pm)$, we define the *f-cabling* of D as an element $C_f(D) \in \mathcal{A}(C_f(X))$ representing a morphism

$$C_f(D): C_{f_s}(w) \longrightarrow C_{f_t}(w') \quad \text{in } \mathcal{A}$$

as follows. Let f_s be the obvious map $\{1, \dots, |w|\} \rightarrow \pi_0(X)$ composed with f , and define f_t similarly. Then we obtain $C_f(D)$ from D by applying, to every connected component $c \subset X$, the usual “deleting operation” ϵ if $|f(c)| = 0$, or the usual “doubling operation” Δ repeatedly to get $|f(c)|$ new solid components if $|f(c)| > 0$, and then the usual “orientation-reversal operation” S to every new solid component corresponding to a letter $-$ in the word $f(c)$. (The definitions of the operations ϵ , Δ and S appear in [54, §6.1] for instance.)

We can easily verify the following analog of Lemma 3.1.

Lemma 3.6. *Let D and D' be Jacobi diagrams on polarized 1-manifolds X and X' , respectively, with $s(X) = t(X')$. Let $f: \pi_0(X) \rightarrow \text{Mon}(\pm)$, $f': \pi_0(X') \rightarrow \text{Mon}(\pm)$ be maps with $f_s = f'_t$. Then we have*

$$C_{f \cup f'}(D \circ D') = C_f(D) \circ C_{f'}(D'), \quad (3.6)$$

where $f \cup f'$ denotes the unique map $\pi_0(X \cup_{s(X)=t(X')} X') \rightarrow \text{Mon}(\pm)$ compatible with f and f' .

3.7. The Kontsevich integral Z . Let $\Phi \in \mathcal{A}(\downarrow\downarrow\downarrow)$ be an *associator*. In other words, Φ is the exponential of a series of connected Jacobi diagrams on $\downarrow\downarrow\downarrow$ which trivializes if any of the three strings is deleted, and Φ is solution of one “pentagon” equation and two “hexagon” equations; see [54, (6.11)–(6.13)]. Define

$$\nu = \left(\begin{array}{c} \downarrow \\ \boxed{S_2(\Phi)} \\ \downarrow \end{array} \right)^{-1} = \downarrow + \frac{1}{48} \begin{array}{c} \downarrow \\ \text{---} \\ \downarrow \end{array} + (\text{deg} > 2) \in \mathcal{A}(\downarrow), \quad (3.7)$$

where $S_2: \mathcal{A}(\downarrow\downarrow\downarrow) \rightarrow \mathcal{A}(\downarrow\uparrow\downarrow)$ is the diagrammatic “orientation-reversal operation” applied to the second string.

Theorem 3.7 (See [6, 8, 39, 57, 31]). *Fix $a, u \in \mathbb{Q}$ with $a + u = 1$. There is a unique tensor-preserving functor $Z: \mathcal{T}_q \rightarrow \mathcal{A}$ such that*

- (i) Z is the canonical map $U: \text{Mag}(\pm) \rightarrow \text{Mon}(\pm)$ on objects,
- (ii) for $\gamma: w \rightarrow w'$ in \mathcal{T}_q , we have $Z(\gamma) \in \mathcal{A}(\gamma)_{\mathfrak{S}_{c(\gamma)}} \subset \mathcal{A}(w, w')$,
- (iii) for $\gamma: w \rightarrow w'$ in \mathcal{T}_q and $\ell \in \pi_0(\gamma)$, the value of Z on the q -tangle obtained from γ by reversing the orientation of ℓ is $S_\ell(Z(\gamma))$,
- (iv) Z takes the following values on elementary q -tangles:

$$Z \left(\begin{array}{c} (++) \\ \swarrow \downarrow \\ (++) \end{array} \right) = \exp \left(\frac{1}{2} \begin{array}{c} \downarrow \text{---} \\ \swarrow \downarrow \end{array} \right) \in \mathcal{A} \left(\begin{array}{c} ++ \\ \swarrow \downarrow \\ ++ \end{array} \right) \subset \mathcal{A}(++, ++),$$

$$Z \left(\begin{array}{c} (w(w'w'')) \\ \downarrow \swarrow \downarrow \\ ((w')w'') \end{array} \right) = C_{w, w', w''}(\Phi) \in \mathcal{A} \left(\downarrow \begin{array}{c} w w' w'' \\ \dots \dots \end{array} \downarrow \right) \subset \mathcal{A}(w w' w'', w w' w'')$$

for $w, w', w'' \in \text{Mag}(\pm)$,

$$Z \left(\begin{array}{c} \downarrow \uparrow \\ (+-) \end{array} \right) = \begin{array}{c} \nu^a \\ \downarrow \uparrow \end{array} \in \mathcal{A} \left(\begin{array}{c} \downarrow \uparrow \\ +- \end{array} \right) \subset \mathcal{A}(\emptyset, +-),$$

$$Z \left(\begin{array}{c} \uparrow \downarrow \\ (+-) \end{array} \right) = \begin{array}{c} \nu^u \\ \uparrow \downarrow \end{array} \in \mathcal{A} \left(\begin{array}{c} \uparrow \downarrow \\ +- \end{array} \right) \subset \mathcal{A}(+-, \emptyset).$$

The proof of the case $a = u = 1/2$ [54, Theorem 6.7, Proposition 6.8(2)] apply to the general case. (The reader should, however, be aware that the composition laws for the categories \mathcal{T}_q and \mathcal{A} adopted in [54] are opposite to ours.)

Now we review the behavior of the Kontsevich integral under cabling. For $w \in \text{Mag}(\pm)$, define $a_w, a'_w, u_w, u'_w \in \mathcal{A}(\downarrow \cdot \overset{w}{\cdot} \downarrow) \subset \mathcal{A}(w, w)$ by

$$\begin{aligned}
 ZC_w \left(\begin{array}{c} \curvearrowright \\ (+-) \end{array} \right) &= \begin{array}{c} \boxed{C_w Z \left(\begin{array}{c} \curvearrowright \\ (+-) \end{array} \right)} \\ \downarrow \downarrow \\ \boxed{a_w} \\ \downarrow \downarrow \\ \dots \quad \downarrow \quad \downarrow \quad \dots \\ w \quad \quad \quad w^* \end{array}, & ZC_w \left(\begin{array}{c} \curvearrowright \\ (-+) \end{array} \right) = \begin{array}{c} \boxed{C_w Z \left(\begin{array}{c} \curvearrowright \\ (-+) \end{array} \right)} \\ \downarrow \downarrow \\ \dots \quad \downarrow \quad \downarrow \quad \dots \\ w^* \quad \quad \quad w \end{array}, \\
 \\
 ZC_w \left(\begin{array}{c} \curvearrowleft \\ (+-) \end{array} \right) &= \begin{array}{c} \downarrow \downarrow \\ \boxed{u_w} \\ \downarrow \downarrow \\ \dots \quad \downarrow \quad \downarrow \quad \dots \\ w \quad \quad \quad w^* \\ \boxed{C_w Z \left(\begin{array}{c} \curvearrowleft \\ (+-) \end{array} \right)} \end{array}, & ZC_w \left(\begin{array}{c} \curvearrowleft \\ (-+) \end{array} \right) = \begin{array}{c} \downarrow \downarrow \\ \dots \quad \downarrow \quad \downarrow \quad \dots \\ w^* \quad \quad \quad w \\ \boxed{C_w Z \left(\begin{array}{c} \curvearrowleft \\ (-+) \end{array} \right)} \end{array}.
 \end{aligned}$$

Lemma 3.8. For $w \in \text{Mag}(\pm)$, we have $a_w = a'_w$, $u_w = u'_w$ and $a_w = (u_w)^{-1}$.

Proof. Using Lemmas 3.1 and 3.6, we can deduce $a_w = a'_w$, $u_w = u'_w$ and $a'_w u_w = 1$ from

respectively. See the proof of [54, Proposition 6.8(1)] for the case $a = u = 1/2$ and $w = (++)$. We can easily adapt the arguments given there to the general case. \square

For $w \in \text{Mon}(\pm)$ and $f: \{1, \dots, |w|\} \rightarrow \text{Mag}(\pm)$, we obtain

$$c(w, f): C_f(w) \longrightarrow C_f(w) \quad \text{in } \mathcal{A}$$

from $\text{id}_w: w \rightarrow w$ by replacing, for each $i \in \{1, \dots, |w|\}$, the i -th string with $a_{f(i)}$ if $w_i = +$ and with $\text{id}_{f(i)^*}$ if $w_i = -$.

Lemma 3.9. *For a q -tangle $\gamma: w \rightarrow w'$ and $f: \pi_0(\gamma) \rightarrow \text{Mag}(\pm)$, we have*

$$ZC_f(\gamma) = c(w', f_t) \circ C_f Z(\gamma) \circ c(w, f_s)^{-1}.$$

Here, f_s is the composition of f with the map $\{1, \dots, |w|\} \rightarrow \pi_0(\gamma)$ relating the top boundary points of γ to its connected components, and f_t is defined similarly.

Proof. This lemma is proved by adapting the arguments of [40, Lemma 4.1], and by using Lemma 3.8. □

To conclude this section, we emphasize that there are several “good” choices of a and u in Theorem 3.7. The most common choice is to take $a = u = 1/2$. However, for technical convenience, we set

$$a = 0, \quad u = 1.$$

Thus, in what follows, the “cabling anomaly” $a_w \in \mathcal{A}(\downarrow \cdot \cdot \downarrow) \subset \mathcal{A}(w, w)$ assigned to $w \in \text{Mag}(\pm)$ satisfies

$$ZC_w \left(\begin{array}{c} \curvearrowright \\ (+-) \end{array} \right) = \begin{array}{c} \text{---} \\ \text{---} \\ \text{---} \\ \boxed{a_w} \\ \text{---} \\ \text{---} \\ \text{---} \\ \downarrow \cdot \cdot \downarrow \end{array} \cdot \quad (3.8)$$

4. The category \mathbf{A} of Jacobi diagrams in handlebodies

In this section, we introduce the linear symmetric strict monoidal category \mathbf{A} of Jacobi diagrams in handlebodies.

4.1. Spaces of colored Jacobi diagrams. Here we define the notion of Jacobi diagrams *colored by elements of a group* [17, 42], and define the space $\mathcal{A}(X, \pi)$ of π -colored Jacobi diagrams on a 1-manifold X , where π is a group.

Let S be a set, and D a Jacobi diagram on a compact, oriented 1-manifold X . An S -coloring of D consists of an orientation of each edge of D and an S -valued function on a (possibly empty) finite subset of $(\text{int } X \cup D) \setminus \text{Vert}(D)$. In figures, the S -valued function is encoded by “beads” colored with elements of S . We identify two S -colored Jacobi diagrams D and D' on X if there is a homeomorphism $(X \cup D, X) \cong (X \cup D', X)$ preserving the orientations and the connected components of X , respecting the vertex-orientations and compatible with the S -colorings. These definitions for Jacobi diagrams restrict to chord diagrams.

Now, let $S = \pi$ be a group. Two π -colorings of a chord diagram D on X are said to be *equivalent* if they are related by a sequence of the following local moves:

$$\begin{array}{c}
 \begin{array}{ccc}
 \begin{array}{c} \bullet \\ x \end{array} \begin{array}{c} \bullet \\ y \end{array} \rightarrow \leftrightarrow \begin{array}{c} \bullet \\ xy \end{array} \rightarrow & , & \begin{array}{c} \bullet \\ 1 \end{array} \rightarrow \leftrightarrow \rightarrow \\
 \forall x, y \in \pi, & \begin{array}{ccc}
 \begin{array}{c} \cdots \bullet \cdots \\ x \end{array} \begin{array}{c} \bullet \\ y \end{array} \rightarrow \leftrightarrow \begin{array}{c} \bullet \\ xy \end{array} \rightarrow & , & \begin{array}{c} \cdots \bullet \cdots \\ 1 \end{array} \rightarrow \leftrightarrow \cdots \rightarrow \\
 \begin{array}{c} \cdots \bullet \cdots \\ x \end{array} \rightarrow \leftrightarrow \leftarrow \begin{array}{c} \cdots \bullet \cdots \\ \bar{x} \end{array} & , & \begin{array}{c} \nearrow \\ x \end{array} \rightarrow \leftrightarrow \begin{array}{c} \nearrow \\ x \end{array} \rightarrow
 \end{array}
 \end{array} \tag{4.1}$$

Here and in what follows, we use the notation $\bar{x} = x^{-1}$. (In the fifth relation above, it is understood that, if there are several beads on the reversed edge, then the colors at all the beads on it should be inverted.)

Example 4.1. Here are several equivalent π -colored chord diagram on $\uparrow \uparrow$, where $x, y \in \pi$.

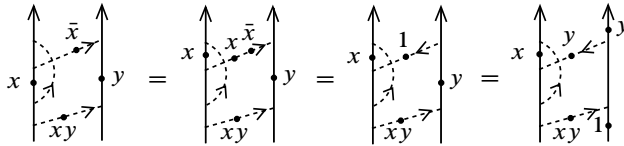

Similarly, two π -colorings of a Jacobi diagram D on X are said to be *equivalent* if they are related by a sequence of the local moves in (4.1) and

$$\forall x \in \pi, \quad \begin{array}{c} \nearrow \\ x \end{array} \begin{array}{c} \nearrow \\ x \end{array} \leftrightarrow \begin{array}{c} \nearrow \\ x \end{array} \begin{array}{c} \searrow \\ x \end{array}$$

Thus, π -colored Jacobi diagrams generalize π -colored chord diagrams. Here is a topological interpretation of π -colorings.

Lemma 4.2. *Let D be a Jacobi diagram on X with no closed component. Then there is a bijection between the set of equivalence classes of π -colorings of D and $\text{Hom}(\pi_1((X \cup D)/\partial X, \{\partial X\}), \pi)$.*

Corollary 4.3. *Let D and X be as in Lemma 4.2. Let $\pi = \pi_1(M, \star)$ for a pointed space (M, \star) , and assume that ∂X is embedded in a contractible neighborhood of \star in M . Then the equivalence classes of π -colorings of D correspond bijectively to the homotopy classes (rel ∂X) of continuous maps $(X \cup D, \partial X) \rightarrow (M, \partial X)$.*

Proof of Lemma 4.2. Let c be a π -coloring of D , and let α be a loop in $(X \cup D)/\partial X$ based at $\{\partial X\}$. Let $\varphi_c(\alpha) \in \pi$ be the product of the contributions of all the consecutive beads along α , where each bead contributes either by its color or its inverse depending on compatibility of α with the orientation at the bead. This clearly defines a homomorphism $\varphi_c: \pi_1((X \cup D)/\partial X, \{\partial X\}) \rightarrow \pi$, depending only on the equivalence class of c . Thus, we obtain a map $\{c\} \mapsto \varphi_c$, from the set of equivalence classes of π -colorings of D to $\text{Hom}(\pi_1((X \cup D)/\partial X, \{\partial X\}), \pi)$. One can construct the inverse map by using a maximal tree of the graph $(X \cup D)/\partial X$; see [17, Lemma 4.3] for a very similar result. \square

A π -colored Jacobi diagram D on X is said to be *restricted* if D has no bead (but there may be beads on X). Two restricted π -colorings of a Jacobi diagram D on X are said to be *equivalent* if they are related by a sequence of the first two moves in (4.1) and

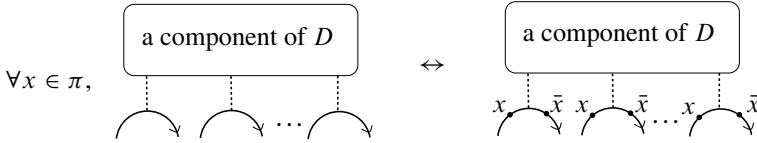

The above figure shows all the univalent vertices (and their neighborhoods in X) of the same connected component of D . For instance, if D is a chord diagram, then there are exactly two such vertices.

Let $\mathcal{A}^{\text{ch}}(X, \pi)$ (resp. $\mathcal{A}^{\text{Jac}}(X, \pi)$) denote the vector space generated by equivalence classes of π -colored chord (resp. Jacobi) diagrams on X , modulo the 4T (resp. STU) relation. There are also “restricted” versions $\mathcal{A}^{\text{ch},r}(X, \pi)$ and $\mathcal{A}^{\text{Jac},r}(X, \pi)$ of $\mathcal{A}^{\text{ch}}(X, \pi)$ and $\mathcal{A}^{\text{Jac}}(X, \pi)$, respectively. We have a commutative diagram of canonical maps:

$$\begin{array}{ccc}
 \mathcal{A}^{\text{ch},r}(X, \pi) & \xrightarrow{u^{\text{ch}}} & \mathcal{A}^{\text{ch}}(X, \pi) \\
 \phi^r \downarrow & & \downarrow \phi \\
 \mathcal{A}^{\text{Jac},r}(X, \pi) & \xrightarrow{u^{\text{Jac}}} & \mathcal{A}^{\text{Jac}}(X, \pi)
 \end{array} \tag{4.2}$$

The special case $\pi = \{1\}$ of Theorem 4.4 below is due to Bar-Natan [4, Theorem 6]. The general case seems to be new.

Theorem 4.4. *All the maps in (4.2) are isomorphisms. Furthermore, the AS and IHX relations hold in $\mathcal{A}^{\text{Jac},r}(X, \pi)$ and $\mathcal{A}^{\text{Jac}}(X, \pi)$.*

Proof. By the STU relation, ϕ^r is surjective. The map ϕ is also surjective by the same reason and the following observation: each bead in the neighborhood of a

univalent vertex of a π -colored Jacobi diagram on X can be displaced from D using the last move of (4.1) (without changing the equivalence class of the π -coloring). Therefore, it suffices to prove that

- (i) ϕ is injective,
- (ii) u^{ch} is an isomorphism,
- (iii) the AS and IHX relations hold in $\mathcal{A}^{\text{Jac}}(X, \pi)$.

The AS and IHX relations in $\mathcal{A}^{\text{Jac}}(X, \pi)$ reduce to the STU relation by using the above observation and the arguments of the last two paragraphs in the proof of [4, Theorem 6]. This proves (iii).

To prove (ii) we construct an inverse to u^{ch} . Applying the operation

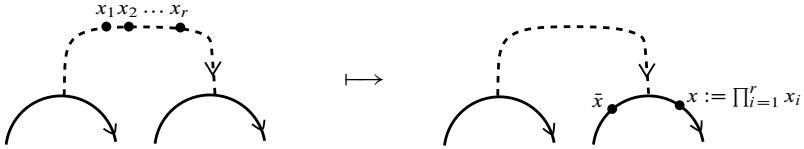

to all the chords transforms each π -colored chord diagram on X into a restricted one. It is easy to check that this operation maps equivalent π -colorings to equivalent π -colorings and defines an inverse to u^{ch} .

To prove (i), we partly follow the proof of [4, Theorem 6]. Let Y be a compact, oriented 1-manifold. Let $\mathcal{D}^{\text{Jac}}(Y, \pi)$ denote the set of equivalence classes of π -colored Jacobi diagrams on Y . For $k \geq 0$, let $\mathcal{D}_k^{\text{Jac}}(Y, \pi) \subset \mathcal{D}^{\text{Jac}}(Y, \pi)$ consist of diagrams with exactly k trivalent vertices. Let $\psi_0: \mathcal{D}_0^{\text{Jac}}(Y, \pi) \rightarrow \mathcal{A}^{\text{ch}}(Y, \pi)$ be the canonical map.

Claim. *There are maps $\psi_k: \mathcal{D}_k^{\text{Jac}}(Y, \pi) \rightarrow \mathcal{A}^{\text{ch}}(Y, \pi)$ for $k \geq 1$ such that we have*

$$\psi_k(D^S) = \psi_{k-1}(D_i^T) - \psi_{k-1}(D_i^U)$$

for $k \geq 1$ and $D^S \in \mathcal{D}_k^{\text{Jac}}(Y, \pi)$, where i denotes a univalent vertex of D^S adjacent to a trivalent vertex v_i and where $D_i^T, D_i^U \in \mathcal{D}_{k-1}^{\text{Jac}}(Y, \pi)$ differ from D^S around i as shown in the STU relation (3.3).

Applying this claim to $Y = X$, we obtain a left inverse $\psi: \mathcal{A}^{\text{Jac}}(X, \pi) \rightarrow \mathcal{A}^{\text{ch}}(X, \pi)$ to ϕ . This proves (i) and concludes the proof of Theorem 4.4. \square

Proof of Claim. By the 4T relation, ψ_1 is well defined from ψ_0 . Let $k > 1$ and suppose $\psi_1, \dots, \psi_{k-1}$ have been defined for all compact, oriented 1-manifolds Y . To have ψ_k well defined, we need to check

$$\psi_{k-1}(D_i^T) - \psi_{k-1}(D_i^U) = \psi_{k-1}(D_j^T) - \psi_{k-1}(D_j^U) \quad (4.3)$$

for all $D^S \in \mathcal{D}_k^{\text{Jac}}(Y, \pi)$ and all univalent vertices i and j of D^S adjacent to some trivalent vertices v_i and v_j , respectively. If $v_i \neq v_j$, then we can apply the argument in the second paragraph of the proof of [4, Theorem 6]. If $v_i = v_j$, then the arguments provided in [4] for this situation do not fully apply when $\pi \neq \{1\}$, because of the “exceptional case” alluded to in the third paragraph of the proof of [4, Theorem 6]. Thus, we need a different proof.

First, observe that the maps $\psi_0, \dots, \psi_{k-1}$ defined so far have the following properties: for every oriented 1-manifold $Y' \uparrow$ with a distinguished component \uparrow , the diagrams

$$\begin{array}{ccc} \mathbb{K}\mathcal{D}_i^{\text{Jac}}(Y' \uparrow, \pi) & \xrightarrow{\psi_i} & \mathcal{A}^{\text{ch}}(Y' \uparrow, \pi) \\ \Delta \downarrow & & \downarrow \Delta \\ \mathbb{K}\mathcal{D}_i^{\text{Jac}}(Y' \uparrow \uparrow, \pi) & \xrightarrow{\psi_i} & \mathcal{A}^{\text{ch}}(Y' \uparrow \uparrow, \pi) \end{array} \tag{4.4a}$$

and

$$\begin{array}{ccc} \mathbb{K}\mathcal{D}_i^{\text{Jac}}(Y' \uparrow, \pi) & \xrightarrow{\psi_i} & \mathcal{A}^{\text{ch}}(Y' \uparrow, \pi) \\ S \downarrow & & \downarrow S \\ \mathbb{K}\mathcal{D}_i^{\text{Jac}}(Y' \downarrow, \pi) & \xrightarrow{\psi_i} & \mathcal{A}^{\text{ch}}(Y' \downarrow, \pi) \end{array} \tag{4.4b}$$

commute for $i \in \{0, \dots, k-1\}$. (Here the doubling operations Δ and the orientation-reversal operations S for colored chord/Jacobi diagrams are defined in the same way as for uncolored chord/Jacobi diagrams, except that beads of a duplicated component should be repeated on each new component, and beads of a reversed component should be transformed into their inverses.) Next, we draw D^S as follows:

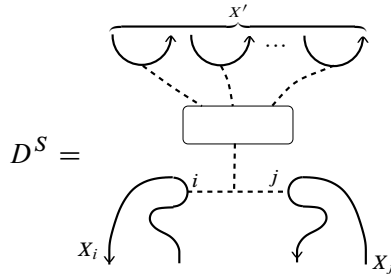

Here the arcs X_i, X_j are neighborhoods in X of the vertices i, j , and $X' \subset X$ is a neighborhood of the remaining univalent vertices of D^S . From this local picture

In what follows, let $\mathcal{A}(X, \pi)$ denote the isomorphic spaces

$$\mathcal{A}^{\text{ch,r}}(X, \pi) \cong \mathcal{A}^{\text{ch}}(X, \pi) \cong \mathcal{A}^{\text{Jac,r}}(X, \pi) \cong \mathcal{A}^{\text{Jac}}(X, \pi).$$

For instance, if $\pi = \{1\}$, then we have $\mathcal{A}(X) \cong \mathcal{A}(X, \{1\})$. In general, $\mathcal{A}(X)$ embeds into $\mathcal{A}(X, \pi)$ by the following lemma.

Lemma 4.5. *If X has no closed component, then the canonical map from $\mathcal{A}(X)$ to $\mathcal{A}(X, \pi)$ is injective.*

Proof. For every Jacobi diagram D on X with π -coloring c , define $p(D, c) \in \mathcal{A}(X)$ by

$$p(D, c) = \begin{cases} D \text{ with } c \text{ deleted} & \text{if } \varphi_c \text{ is trivial,} \\ 0 & \text{otherwise,} \end{cases} \quad (4.5)$$

where $\varphi_c: \pi_1((X \cup D)/\partial X, \{\partial X\}) \rightarrow \pi$ is the homomorphism corresponding to c by Lemma 4.2. Observe that, for all π -colored Jacobi diagrams (D, c) and (D', c') on X involved in an STU relation, there is a homotopy equivalence $h: X \cup D \xrightarrow{\cong} X \cup D'$ rel ∂X such that $\varphi_{c'} \circ h_* = \varphi_c$. Hence (4.5) induces a linear map $p: \mathcal{A}(X, \pi) \rightarrow \mathcal{A}(X)$. Clearly, $p \circ i = \text{id}_{\mathcal{A}(X)}$, where $i: \mathcal{A}(X) \rightarrow \mathcal{A}(X, \pi)$ is the canonical map. \square

Remark 4.6. There are analogs of Lemmas 4.2 and 4.5 for compact, oriented 1-manifolds with closed components. Moreover, we can extend Lemma 4.5 as follows: if X has no closed components, then the map $\mathcal{A}(X, \pi') \rightarrow \mathcal{A}(X, \pi)$ induced by an injective group homomorphism $\pi' \rightarrow \pi$ is injective. We will not need these generalizations in what follows.

4.2. The category \mathbf{A} of Jacobi diagrams in handlebodies. Now we introduce the linear category \mathbf{A} of Jacobi diagrams in handlebodies. Set $\text{Ob}(\mathbf{A}) = \mathbb{N}$.

For $m \geq 0$, let $F_m = F(x_1, \dots, x_m)$ be the free group on $\{x_1, \dots, x_m\}$. We identify F_m with $\pi_1(V_m, \ell)$ (see Section 2). Here x_1, \dots, x_m are represented by the “stretched cores” A_1, \dots, A_m of the handles of V_m . For $n \geq 0$, let

$$X_n = \bigcap_1 \cdots \bigcap_n$$

be an oriented 1-manifold consisting of n arc components.

For $m, n \geq 0$, set

$$\mathbf{A}(m, n) = \mathcal{A}(X_n, F_m),$$

which is generated by F_m -colored Jacobi diagrams on X_n . We will call them (m, n) -Jacobi diagrams for brevity. Using Corollary 4.3, we may regard an

(m, n) -Jacobi diagram as a homotopy class $\text{rel } \partial X_n$ of maps

$$X_n \cup D \longrightarrow V_m. \tag{4.6}$$

Here we assume that the $2n$ boundary points of X_n are uniformly distributed along the line ℓ . Since V_m deformation-retracts onto a square with m handles, we can present an (m, n) -Jacobi diagram D by a projection diagram of the corresponding homotopy class of maps (4.6).

Example 4.7. Here are a $(2, 3)$ -Jacobi diagram and its projection diagram in the square with handles:

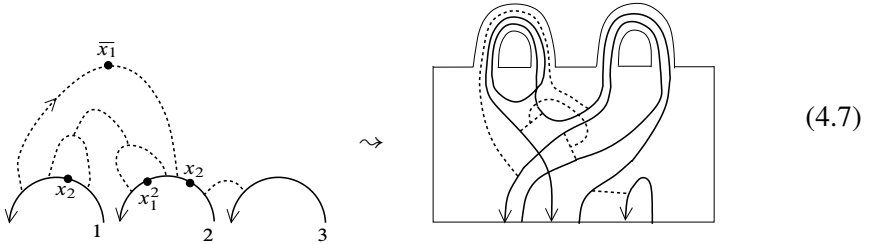

We will use the following convention for presenting the morphisms in \mathbf{A} . A *square presentation* of a restricted (m, n) -Jacobi diagram D is a projection diagram of D in the square with m handles, such that the dashed part of D does not appear in the handles. Thus a square presentation of D consists of words $w_1, \dots, w_n \in \text{Mon}(\pm)$ and a Jacobi diagram

$$S: w_1 w_1^* \cdots w_m w_m^* \longrightarrow (+-)^n \quad \text{in } \mathbf{A}$$

such that

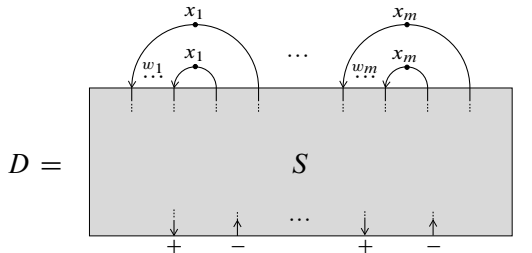

In what follows, we write $d(w) = w w^* \in \text{Mon}(\pm)$ for $w \in \text{Mon}(\pm)$. Since $\mathbf{A}(m, n)$ is spanned by restricted (m, n) -Jacobi diagrams, we can regard its elements as linear combinations of square presentations.

Example 4.8. Here is a restricted (2, 3)-Jacobi diagram D , together with a square presentation S such that $w_1 = w_2 = ++$:

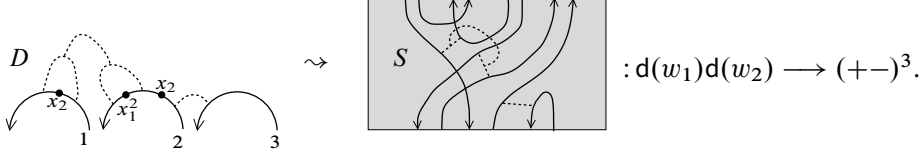

Now we define the composition in \mathbf{A} . We compose an (n, p) -Jacobi diagram D' with an (m, n) -Jacobi diagram D as follows. First, we may assume that each bead of D' is colored by $x_i^{\pm 1}$ for some i , by using the moves in (4.1). For each $j \in \{1, \dots, n\}$, let k_j be the number of beads colored by $x_j^{\pm 1}$ in D' and number them from 1 to k_j in an arbitrary way. This defines a word $\kappa(j) \in \text{Mon}(\pm)$ of length k_j by assigning a letter $+$ to each x_j -colored bead and a letter $-$ to each x_j^{-1} -colored bead. Let

$$C_\kappa(D) \in \mathcal{A}(X_{k_1 + \dots + k_n}, F_m)$$

be the linear combination of $(m, k_1 + \dots + k_n)$ -Jacobi diagrams obtained from D by κ -cabling, i.e., by repeated applications of the deleting operation ϵ , the doubling operation Δ and the orientation-reversal operation S . By using the correspondence between the beads of D' and the solid components of $C_\kappa(D)$ induced by their numberings, we can identify some local neighborhoods of the former with the latter in an orientation-preserving way. Thus, by “gluing” $C_\kappa(D)$ to D' accordingly, we obtain a linear combination of (m, p) -Jacobi diagrams

$$D' \tilde{\circ} D \in \mathcal{A}(X_p, F_m) = \mathbf{A}(m, p).$$

Clearly, $D' \tilde{\circ} D$ depends only on the equivalence class of D , but not on the numbering of the beads of D' . By the STU relation, $D' \tilde{\circ} D$ depends only on the equivalence class of D' .

Example 4.9. We can describe the operation $\tilde{\circ}$ in terms of projection diagrams in squares with handles, using the box notation recalled in Example 3.2. For instance, let $m = n = p = 2$ and

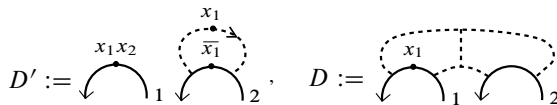

with the projection diagrams

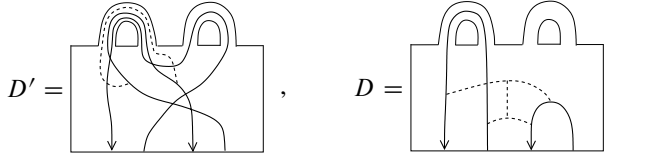

Then, setting $x = x_1$, we have

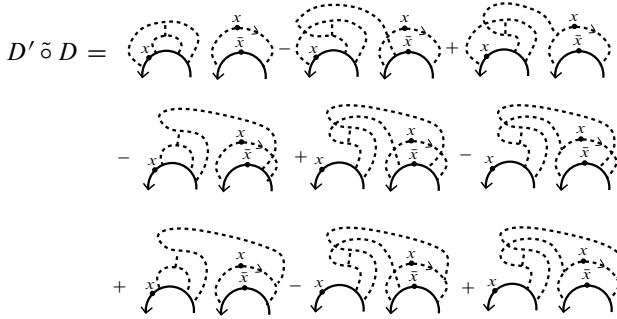

with the projection diagram

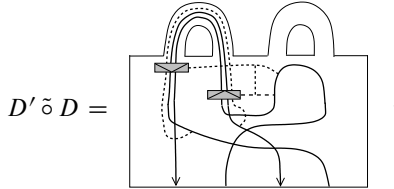

One can easily verify the following lemma.

Lemma 4.10. *Let D be a restricted (m, n) -Jacobi diagram and let D' be a restricted (n, p) -Jacobi diagram, with square presentations*

$$S: d(w_1) \cdots d(w_m) \longrightarrow (+-)^n \quad \text{and} \quad S': d(w'_1) \cdots d(w'_n) \longrightarrow (+-)^p,$$

respectively. Then

$$S' \circ C_f(S): C_{f_t}(d(w_1) \cdots d(w_m)) \longrightarrow (+-)^p$$

is a square presentation of $D' \circ D$, where \circ denotes the composition in \mathcal{A} ,

$$f: \pi_0(1\text{-manifold underlying } S) \longrightarrow \text{Mon}(\pm)$$

is defined in the obvious way from w'_1, \dots, w'_n and the polarized oriented 1-manifold underlying S , and $f_t: \{1, \dots, 2|w_1| + \dots + 2|w_m|\} \rightarrow \text{Mon}(\pm)$ is induced by f .

Using Lemma 4.10, we can easily prove the following.

Lemma 4.11. *For $m, n, p \geq 0$, there is a unique bilinear map*

$$\circ: \mathbf{A}(n, p) \times \mathbf{A}(m, n) \longrightarrow \mathbf{A}(m, p)$$

such that $D' \circ D = D' \circ D$ for each (m, n) -Jacobi diagram D and each (n, p) -Jacobi diagram D' .

Finally, the following lemma shows that we have a well-defined linear category \mathbf{A} with the above composition \circ and the identity

$$\text{id}_n := \left(\begin{array}{c} \curvearrowright_{x_1} \curvearrowright_{x_2} \cdots \curvearrowright_{x_n} \\ \downarrow_1 \cdots \downarrow_n \end{array} \right) = \left(\begin{array}{c} \text{1} \quad \cdots \quad \text{n} \\ \text{---} \text{---} \text{---} \text{---} \\ \text{---} \text{---} \text{---} \text{---} \\ \text{---} \text{---} \text{---} \text{---} \\ \downarrow \quad \cdots \quad \downarrow \end{array} \right).$$

Lemma 4.12. *If $m \xrightarrow{D} n \xrightarrow{D'} p \xrightarrow{D''} q$ in \mathbf{A} , then we have*

$$\left(\begin{array}{c} \curvearrowright_{x_1} \curvearrowright_{x_2} \cdots \curvearrowright_{x_n} \\ \downarrow_1 \cdots \downarrow_n \end{array} \right) \circ D = D, \quad (4.8)$$

$$D' \circ \left(\begin{array}{c} \curvearrowright_{x_1} \curvearrowright_{x_2} \cdots \curvearrowright_{x_n} \\ \downarrow_1 \cdots \downarrow_n \end{array} \right) = D', \quad (4.9)$$

$$D'' \circ (D' \circ D) = (D'' \circ D') \circ D. \quad (4.10)$$

Proof. We may assume that D , D' and D'' are restricted. Let

$$S: d(w_1) \cdots d(w_m) \longrightarrow (+-)^n,$$

$$S': d(w'_1) \cdots d(w'_n) \longrightarrow (+-)^p,$$

$$S'': d(w''_1) \cdots d(w''_p) \longrightarrow (+-)^q.$$

be square presentations of D , D' and D'' , respectively.

First, by Lemma 4.10, a square presentation of $\left(\begin{array}{c} \curvearrowright_{x_1} \curvearrowright_{x_2} \cdots \curvearrowright_{x_n} \\ \downarrow_1 \cdots \downarrow_n \end{array} \right) \circ D$ is

$$(\downarrow \uparrow \cdots \downarrow \uparrow) \circ S = S.$$

This proves (4.8).

Next, a square presentation of $D' \circ \left(\begin{array}{c} \curvearrowright_{x_1} \curvearrowright_{x_2} \cdots \curvearrowright_{x_n} \\ \downarrow_1 \cdots \downarrow_n \end{array} \right)$ is

$$S' \circ C_f(\downarrow \uparrow \cdots \downarrow \uparrow) = S',$$

where $f: \pi_0(\downarrow \uparrow \cdots \downarrow \uparrow) \rightarrow \text{Mon}(\pm)$ is the unique map such that $C_{f_t}(+-\cdots+-) = d(w'_1) \cdots d(w'_n)$. This proves (4.9).

Finally, a square presentation of $D'' \circ (D' \circ D)$ is

$$S'' \circ C_{f'}(S' \circ C_f(S)) = S'' \circ (C_{f'_0}(S') \circ C_{f_0}(S))$$

for some maps f, f', f_0 and f'_0 . By associativity of the composition in \mathcal{A} , the latter is a square presentation of $(D'' \circ D') \circ D$. This proves (4.10). \square

4.3. A symmetric monoidal structure on \mathbf{A} . We define a symmetric monoidal structure on the linear category \mathbf{A} as follows. The tensor product on objects is addition. The monoidal unit is 0. The tensor product on morphisms is juxtaposition followed by relabelling the solid arcs and the beads. More precisely, we obtain the tensor product $D \otimes D'$ of an (m, n) -Jacobi diagram D and an (m', n') -Jacobi diagram D' from the juxtaposition of D and D' by renaming \frown_j in D' with \frown_{n+j} for $j = 1, \dots, n'$, and replacing x_i with x_{m+i} for $i = 1, \dots, m'$.

Lemma 4.13. *The strict monoidal category \mathbf{A} admits a symmetry defined by*

$$P_{m,n} = \begin{array}{c} \begin{array}{c} \overbrace{\phantom{\text{---}}}^m \quad \overbrace{\phantom{\text{---}}}^n \\ \text{---} \end{array} \\ \text{---} \\ \begin{array}{c} \underbrace{\phantom{\text{---}}}^n \quad \underbrace{\phantom{\text{---}}}^n \end{array} \end{array} : m+n \longrightarrow n+m. \quad (4.11)$$

Proof. We show that the $P_{m,n}$ are natural in m and n . To post-compose a Jacobi diagram in $\mathbf{A}(n+m, k)$ with $P_{m,n}$, one transforms the labels of the beads by

$$x_1 \mapsto x_{n+1}, \dots, x_m \mapsto x_{n+m}, \quad x_{m+1} \mapsto x_1, \dots, x_{m+n} \mapsto x_n.$$

To pre-compose a Jacobi diagram in $\mathbf{A}(k, m+n)$ with $P_{m,n}$, one transforms the labels of the arcs by

$$1 \mapsto n+1, \dots, m \mapsto n+m, \quad m+1 \mapsto 1, \dots, m+n \mapsto n.$$

It follows that, for $U: m \rightarrow m'$ and $V: n \rightarrow n'$, we have

$$(V \otimes U) \circ P_{m,n} = P_{m',n'} \circ (U \otimes V),$$

i.e., $P_{m,n}$ is natural.

One can easily check the other axioms of symmetric monoidal category. \square

Before giving a presentation of the category \mathbf{A} in the next section, we describe some additional structures in \mathbf{A} .

4.4. Two gradings on \mathbf{A} . We first define an \mathbb{N} -grading on \mathbf{A} . We have

$$\mathbf{A}(m, n) = \bigoplus_{k \in \mathbb{N}} \mathbf{A}_k(m, n)$$

for $m, n \geq 0$, where $\mathbf{A}_k(m, n)$ is spanned by Jacobi diagrams of degree k . (Recall that the *degree* of a Jacobi diagram is half the total number of its vertices.) It is easy to check that \mathbf{A} has the structure of an \mathbb{N} -graded linear strict monoidal category. In what follows, \mathbb{N} -gradings are simply referred to as “gradings”.

Let $\hat{\mathbf{A}}$ denote the degree-completion of \mathbf{A} with respect to the above-defined grading on \mathbf{A} . Thus, we set $\text{Ob}(\hat{\mathbf{A}}) = \text{Ob}(\mathbf{A}) = \mathbb{N}$, and $\hat{\mathbf{A}}(m, n)$ is the degree-completion of $\mathbf{A}(m, n)$.

Before defining the second grading on \mathbf{A} , we define the notion of a linear strict monoidal category graded over a strict monoidal category. This generalizes the notion of a linear category graded over a category considered in [43, 61]. Let \mathcal{D} be a strict monoidal category. A \mathcal{D} -grading on a linear, strict monoidal category \mathcal{C} consists of a monoid homomorphism $i: \text{Ob}(\mathcal{C}) \rightarrow \text{Ob}(\mathcal{D})$ and a direct sum decomposition

$$\mathcal{C}(m, n) = \bigoplus_{d: i(m) \rightarrow i(n)} \mathcal{C}(m, n)_d$$

for each pair of objects m, n in \mathcal{C} , such that

- $\text{id}_m \in \mathcal{C}(m, m)_{\text{id}_{i(m)}}$ for each $m \in \text{Ob}(\mathcal{C})$,
- $\mathcal{C}(n, p)_e \circ \mathcal{C}(m, n)_d \subset \mathcal{C}(m, p)_{e \circ d}$ for all $m, n, p \in \text{Ob}(\mathcal{C})$ and all morphisms $i(m) \xrightarrow{d} i(n) \xrightarrow{e} i(p)$ in \mathcal{D} ,
- $\mathcal{C}(m, n)_d \otimes \mathcal{C}(m', n')_{d'} \subset \mathcal{C}(m \otimes m', n \otimes n')_{d \otimes d'}$ for all $m, n, m', n' \in \text{Ob}(\mathcal{C})$ and all morphisms $d: i(m) \rightarrow i(n)$, $d': i(m') \rightarrow i(n')$ in \mathcal{D} .

Then we say that the linear strict monoidal category \mathcal{C} is \mathcal{D} -graded, or that \mathcal{C} is graded over \mathcal{D} .

For instance, we may regard the \mathbb{N} -grading of \mathbf{A} defined above as a grading over the commutative monoid \mathbb{N} , viewed as a strict monoidal category with one object.

Now we define another grading of \mathbf{A} . Let \mathbf{F} be the full subcategory of the category of groups with $\text{Ob}(\mathbf{F}) := \{F_n \mid n \geq 0\}$, and identify $\text{Ob}(\mathbf{F})$ with \mathbb{N} in the natural way. The category \mathbf{F} has a symmetric strict monoidal structure given by free product. We define an \mathbf{F}^{op} -grading on \mathbf{A} as follows. The *homotopy class* of an (m, n) -Jacobi diagram D is the homomorphism $h(D): F_n \rightarrow F_m$ that maps each generator x_j to the product of the beads along the oriented component \frown_j ; we

emphasize that $h(D)$ is independent of the dashed part of D . Then we have

$$\mathbf{A}(m, n) = \bigoplus_{d \in \mathbf{F}^{\text{op}}(m, n)} \mathbf{A}(m, n)_d,$$

where $\mathbf{A}(m, n)_d$ is spanned by Jacobi diagrams of homotopy class d . It is easy to check that \mathbf{A} has the structure of an \mathbf{F}^{op} -graded linear strict monoidal category.

Let \mathbf{A}_0 denote the degree 0 part of \mathbf{A} , which is a linear, symmetric strict monoidal subcategory of \mathbf{A} . The morphisms in \mathbf{A}_0 are linear combinations of Jacobi diagrams in handlebodies without dashed part, which are fully determined by their homotopy classes. Thus, there is an isomorphism of linear symmetric strict monoidal categories

$$h: \mathbf{A}_0 \xrightarrow{\cong} \mathbb{K}\mathbf{F}^{\text{op}},$$

where $\mathbb{K}\mathbf{F}^{\text{op}}$ denotes the linearization of \mathbf{F}^{op} . The isomorphism h extends to a full linear functor $h: \mathbf{A} \rightarrow \mathbb{K}\mathbf{F}^{\text{op}}$ vanishing on morphisms of positive degree.

Remark 4.14. The \mathbf{F}^{op} -grading of \mathbf{A} induces a (completed) \mathbf{F}^{op} -grading on the degree-completion $\widehat{\mathbf{A}}$ in the obvious way. We have

$$\widehat{\mathbf{A}}(m, n) = \bigoplus_{d \in \mathbf{F}^{\text{op}}(m, n)} \widehat{\mathbf{A}}(m, n)_d$$

where $\widehat{\mathbf{A}}(m, n)_d$ is the degree-completion of $\mathbf{A}(m, n)_d$, and \bigoplus denotes the completed direct sum.

4.5. Coalgebra enrichment of \mathbf{A} . Here we define coalgebra structures on the spaces $\mathbf{A}(m, n)$ ($m, n \geq 0$) by generalizing the usual coalgebra structures of the spaces of Jacobi diagrams [4]. Moreover, we show that the category \mathbf{A} is enriched over cocommutative coalgebras. (See [33] for the definitions in enriched category theory.)

Define a linear map

$$\Delta: \mathbf{A}(m, n) \longrightarrow \mathbf{A}(m, n) \otimes \mathbf{A}(m, n)$$

by

$$\Delta(D) = \sum_{D=D' \sqcup D''} D' \otimes D''$$

for every (m, n) -Jacobi diagram D , where the sum is over all splittings of D as the disjoint union of two parts D' and D'' . Define also a linear map

$$\epsilon: \mathbf{A}(m, n) \longrightarrow \mathbb{K}$$

by $\epsilon(D) = 1$ if D is the empty diagram, and $\epsilon(D) = 0$ otherwise. It is easy to see that $(\mathbf{A}(m, n), \Delta, \epsilon)$ is a cocommutative coalgebra.

Proposition 4.15. *The symmetric monoidal category \mathbf{A} is enriched over the symmetric monoidal category of cocommutative coalgebras. In other words, the linear maps*

$$\begin{aligned} \circ &= \circ_{m,n,p}: \mathbf{A}(n, p) \otimes \mathbf{A}(m, n) \longrightarrow \mathbf{A}(m, p) \quad (m, n, p \geq 0), \\ &\mathbb{K} \longrightarrow \mathbf{A}(m, m), \quad 1 \longmapsto \text{id}_m \quad (m \geq 0), \\ \otimes &: \mathbf{A}(m, n) \otimes \mathbf{A}(m', n') \longrightarrow \mathbf{A}(m + m', n + n') \quad (m, n, m', n' \geq 0), \\ &\mathbb{K} \longrightarrow \mathbf{A}(m + n, n + m), \quad 1 \longmapsto P_{m,n} \quad (m, n \geq 0) \end{aligned}$$

are coalgebra maps.

To prove this proposition, we need the lemma below, which one can easily verify.

Lemma 4.16. *Let S be a square presentation of a restricted (m, n) -Jacobi diagram D . Then $\Delta(S)$ (resp. $\epsilon(S)$), the usual comultiplication (resp. counit) of Jacobi diagrams applied to S , is a square presentation of $\Delta(D)$ (resp. $\epsilon(D)$).*

Proof of Proposition 4.15. We will check that $\circ_{m,n,p}$ is a coalgebra map; clearly, so are the other maps listed in the proposition. Consider restricted Jacobi diagrams $D: m \rightarrow n$ and $D': n \rightarrow p$ in \mathbf{A} with square presentations S and S' , respectively. By Lemma 4.10, $D' \circ D$ admits a square presentation of the form $S' \circ C_f(S)$ for a map f determined by S' . The connected components of the dashed part of $C_f(S)$ are in one-to-one correspondence with those of S . Hence we have

$$\begin{aligned} &\Delta(S' \circ C_f(S)) \\ &= \sum_{S=S_* \sqcup S_{**}} \sum_{S'=S'_* \sqcup S'_{**}} (S'_* \circ C_f(S_*)) \otimes (S'_{**} \circ C_f(S_{**})) \\ &= (\circ \otimes \circ) \left(\sum_{S=S_* \sqcup S_{**}} \sum_{S'=S'_* \sqcup S'_{**}} (S'_* \otimes C_f(S_*)) \otimes (S'_{**} \otimes C_f(S_{**})) \right) \\ &= (\circ \otimes \circ) (\text{id} \otimes P \otimes \text{id}) \left(\sum_{S'=S'_* \sqcup S'_{**}} (S'_* \otimes S'_{**}) \right. \\ &\quad \left. \otimes \sum_{S=S_* \sqcup S_{**}} (C_f(S_*) \otimes C_f(S_{**})) \right) \\ &= (\circ \otimes \circ) (\text{id} \otimes P \otimes \text{id}) (\Delta(S') \otimes (C_f \otimes C_f) \Delta(S)) \\ &= ((-\circ C_f(-)) \otimes (-\circ C_f(-))) (\text{id} \otimes P \otimes \text{id}) (\Delta \otimes \Delta)(S' \otimes S), \end{aligned}$$

where P is the linear map $x \otimes y \mapsto y \otimes x$. We deduce from Lemma 4.16 that

$$\Delta(D' \circ D) = (\circ \otimes \circ)(\text{id} \otimes P \otimes \text{id})(\Delta \otimes \Delta)(D' \otimes D),$$

i.e., $\circ = \circ_{m,n,p}$ preserves comultiplication. Clearly, $\circ_{m,n,p}$ preserves counit, i.e., we have $\epsilon(D' \circ D) = \epsilon(D')\epsilon(D)$. Hence $\circ_{m,n,p}$ is a coalgebra map. \square

Corollary 4.17. *For $m \geq 0$ the coalgebra structure of $\mathbf{A}(m, m)$ and the endomorphism algebra structure of $\mathbf{A}(m, m)$ makes $\mathbf{A}(m, m)$ a cocommutative bialgebra.*

The coalgebra structure on $\mathbf{A}(m, n)$ induces a coalgebra structure on $\widehat{\mathbf{A}}(m, n)$. By Proposition 4.15, $\widehat{\mathbf{A}}$ also is enriched over cocommutative coalgebras. Let

$$\widehat{\mathbf{A}}^{\text{grp}}(m, n) = \{f \in \widehat{\mathbf{A}}(m, n) \mid \Delta(f) = f \otimes f, \epsilon(f) = 1\}$$

be the group-like part of $\widehat{\mathbf{A}}(m, n)$. Then the sets $\widehat{\mathbf{A}}^{\text{grp}}(m, n)$ for $m, n \geq 0$ form a symmetric monoidal subcategory of $\widehat{\mathbf{A}}$, which we call the *group-like part of $\widehat{\mathbf{A}}$* .

5. Presentation of the category \mathbf{A}

In this section, we give a presentation of the category \mathbf{A} of Jacobi diagrams in handlebodies.

5.1. Hopf algebras in symmetric monoidal categories. Let \mathcal{C} be a symmetric strict monoidal category, with monoidal unit I and symmetry $P_{X,Y}: X \otimes Y \rightarrow Y \otimes X$.

Let H be a Hopf algebra in \mathcal{C} with the multiplication, unit, comultiplication, counit and antipode

$$\begin{aligned} \mu: H \otimes H &\longrightarrow H, & \eta: I &\longrightarrow H, \\ \Delta: H &\longrightarrow H \otimes H, & \epsilon: H &\longrightarrow I, \\ S: H &\longrightarrow H. \end{aligned}$$

The axioms for a *Hopf algebra* in \mathcal{C} are

$$\mu(\mu \otimes \text{id}) = \mu(\text{id} \otimes \mu), \quad \mu(\eta \otimes \text{id}) = \text{id} = \mu(\text{id} \otimes \eta), \quad (5.1)$$

$$(\Delta \otimes \text{id})\Delta = (\text{id} \otimes \Delta)\Delta, \quad (\epsilon \otimes \text{id})\Delta = \text{id} = (\text{id} \otimes \epsilon)\Delta, \quad (5.2)$$

$$\epsilon\eta = \text{id}_I, \quad \epsilon\mu = \epsilon \otimes \epsilon, \quad \Delta\eta = \eta \otimes \eta, \quad \Delta\mu = (\mu \otimes \mu)(\text{id} \otimes P \otimes \text{id})(\Delta \otimes \Delta), \quad (5.3)$$

$$\mu(\text{id} \otimes S)\Delta = \mu(S \otimes \text{id})\Delta = \eta\epsilon. \quad (5.4)$$

Here and in what follows, we write $\text{id} = \text{id}_H$ and $P = P_{H,H}$ for simplicity. In the following, we assume that H is *cocommutative*, i.e., we have

$$P\Delta = \Delta. \quad (5.5)$$

We will also use the notions of algebras and coalgebras in symmetric monoidal categories, defined by axioms (5.1) and (5.2), respectively. For $m \geq 0$, define $\mu^{[m]}: H^{\otimes m} \rightarrow H$ and $\Delta^{[m]}: H \rightarrow H^{\otimes m}$ inductively by

$$\begin{aligned} \mu^{[0]} &= \eta, & \mu^{[1]} &= \text{id}, & \mu^{[m]} &= \mu(\mu^{[m-1]} \otimes \text{id}) \quad (m \geq 2), \\ \Delta^{[0]} &= \epsilon, & \Delta^{[1]} &= \text{id}, & \Delta^{[m]} &= (\Delta^{[m-1]} \otimes \text{id})\Delta \quad (m \geq 2). \end{aligned}$$

A (left) H -module in \mathcal{C} is an object M with a morphism $\rho: H \otimes M \rightarrow M$, called a (left) *action*, such that

$$\rho(\mu \otimes \text{id}_M) = \rho(\text{id}_H \otimes \rho), \quad \rho(\eta \otimes \text{id}_M) = \text{id}_M.$$

For H -modules (M, ρ) and (M', ρ') , a morphism $f: M \rightarrow M'$ is a *morphism of H -modules* if

$$f\rho = \rho'(\text{id}_H \otimes f).$$

Since H is a cocommutative Hopf algebra, the category \mathbf{Mod}_H of H -modules inherits from \mathcal{C} a symmetric strict monoidal structure. Specifically, the tensor product of two H -modules (M, ρ) and (M', ρ') is $M \otimes M'$ with the action

$$(\rho \otimes \rho')(\text{id}_H \otimes P_{H,M} \otimes \text{id}_{M'}) (\Delta \otimes \text{id}_M \otimes \text{id}_{M'}): H \otimes M \otimes M' \rightarrow M \otimes M'.$$

The monoidal unit in \mathbf{Mod}_H is the *trivial H -module* (I, ϵ) .

Define the (left) *adjoint action* $\text{ad}: H \otimes H \rightarrow H$ by

$$\text{ad} = \mu^{[3]}(\text{id} \otimes \text{id} \otimes S)(\text{id} \otimes P)(\Delta \otimes \text{id}).$$

Since H is cocommutative, all the structure morphisms $\mu, \eta, \Delta, \epsilon, S$ of H as well as the symmetry $P_{H,H}$ are H -module morphisms with respect to the adjoint action. Thus, the H -module (H, ad) is a cocommutative Hopf algebra in \mathbf{Mod}_H .

5.2. Convolutions. Let \mathcal{C} be a symmetric strict monoidal category. Let (A, μ_A, η_A) be an algebra and $(C, \Delta_C, \epsilon_C)$ a coalgebra in \mathcal{C} . We define the *convolution product* on $\mathcal{C}(C, A)$

$$*: \mathcal{C}(C, A) \times \mathcal{C}(C, A) \longrightarrow \mathcal{C}(C, A) \quad (5.6)$$

by

$$f * g = \mu_A(f \otimes g)\Delta_C$$

for $f, g: C \rightarrow A$. This operation is associative with unit $\eta_A \in C$.

A morphism $f: C \rightarrow A$ is *convolution-invertible* if there is $g: C \rightarrow A$ such that $f * g = g * f = \eta_A \in C$. In this case, we call g the *convolution-inverse* to f , and it is denoted by f^{-1} if there is no fear of confusing it with the inverse of f .

In what follows, we mainly use convolutions when $A = H^{\otimes n}$ and $C = H^{\otimes m}$ ($m, n \geq 0$) for a Hopf algebra H in \mathcal{C} . For example, the convolution on $\mathcal{C}(H, H^{\otimes 2})$ is given by

$$f * g = \mu_2(f \otimes g)\Delta,$$

where $\mu_2 := (\mu \otimes \mu)(\text{id} \otimes P \otimes \text{id})$, and the convolution on $\mathcal{C}(I, H^{\otimes n})$ is given by

$$f * g = \mu_n(f \otimes g), \quad (5.7)$$

where we define $\mu_n: H^{\otimes n} \otimes H^{\otimes n} \rightarrow H^{\otimes n}$ inductively by $\mu_0 = \text{id}_I$, $\mu_1 = \mu$ and

$$\mu_n = (\mu_{n-1} \otimes \mu)(\text{id}^{\otimes n-1} \otimes P_{H, H^{\otimes(n-1)}} \otimes \text{id}) \quad (n \geq 2).$$

This convolution product is defined whenever (H, μ, η) is an algebra in \mathcal{C} .

5.3. Casimir Hopf algebras. Let H be a cocommutative Hopf algebra in a linear symmetric strict monoidal category \mathcal{C} .

Definition 5.1. A *Casimir 2-tensor* for H is a morphism $c: I \rightarrow H^{\otimes 2}$ which is *primitive*, *symmetric* and *invariant*:

$$(\Delta \otimes \text{id})c = c_{13} + c_{23}, \quad (5.8)$$

$$Pc = c, \quad (5.9)$$

$$(\text{ad} \otimes \text{ad})(\text{id} \otimes P \otimes \text{id})(\Delta \otimes c) = c\epsilon, \quad (5.10)$$

where $c_{13} := (\text{id} \otimes \eta \otimes \text{id})c$ and $c_{23} := \eta \otimes c$.

By a *Casimir Hopf algebra* in \mathcal{C} , we mean a cocommutative Hopf algebra in \mathcal{C} equipped with a Casimir 2-tensor.

The condition (5.10) means that $c: I \rightarrow H^{\otimes 2}$ is a morphism of H -modules. Thus a Casimir Hopf algebra (H, c) in \mathcal{C} is also a Casimir Hopf algebra in \mathbf{Mod}_H .

Here are elementary properties of Casimir 2-tensors:

$$(\text{id} \otimes \Delta)c = c_{12} + c_{13}, \quad (5.11)$$

$$(\epsilon \otimes \text{id})c = (\text{id} \otimes \epsilon)c = 0, \quad (5.12)$$

$$(S \otimes \text{id})c = (\text{id} \otimes S)c = -c. \quad (5.13)$$

Lemma 5.2. For $c: I \rightarrow H^{\otimes 2}$, the identity (5.10) is equivalent to

$$\Delta * c\epsilon = c\epsilon * \Delta. \quad (5.14)$$

Proof. It is easy to see that (5.10) is equivalent to $\Delta * c\epsilon * \Delta^- = c\epsilon$, where $\Delta^- := (S \otimes S)\Delta$ is the convolution-inverse to Δ . Thus (5.10) is equivalent to (5.14)* Δ^- . Since Δ is convolution-invertible, (5.10) and (5.14) are equivalent. \square

Proposition 5.3. Let (H, c) be a Casimir Hopf algebra. Then we have a version of the 4T relation in $\mathcal{C}(I, H^{\otimes 3})$:

$$(c_{12} + c_{13}) * c_{23} = c_{23} * (c_{12} + c_{13}). \quad (5.15)$$

Proof. Using (5.11) and (5.14), we have

$$\begin{aligned} (c_{12} + c_{13}) * c_{23} &= (\text{id} \otimes \Delta)c * c_{23} = (\text{id} \otimes (\Delta * c\epsilon))c \\ &= (\text{id} \otimes (c\epsilon * \Delta))c \\ &= c_{23} * (\text{id} \otimes \Delta)c = c_{23} * (c_{12} + c_{13}). \end{aligned} \quad \square$$

Example 5.4. (1) In Section 7, we consider *Casimir Lie algebras* (including semi-simple Lie algebras) and observe that their universal enveloping algebras are instances of Casimir Hopf algebras.

(2) Every linear combination of Casimir 2-tensors is a Casimir 2-tensor. In particular, $0: I \rightarrow H \otimes H$ is a Casimir 2-tensor.

5.4. Casimir Hopf algebras and infinitesimal braidings. The above notion of Casimir Hopf algebra is a Hopf-algebraic version of the notion of infinitesimal braiding for symmetric monoidal categories, introduced by Cartier [8] (see also [30]).

Recall that an *infinitesimal braiding* in a linear symmetric strict monoidal category \mathcal{C} is a natural transformation

$$t_{x,y}: x \otimes y \longrightarrow x \otimes y$$

such that

$$P_{x,y}t_{x,y} = t_{y,x}P_{x,y}, \quad (5.16)$$

$$t_{x,y \otimes z} = t_{x,y} \otimes \text{id}_z + (\text{id}_x \otimes P_{z,y})(t_{x,z} \otimes \text{id}_y)(\text{id}_x \otimes P_{y,z}) \quad (5.17)$$

for $x, y, z \in \text{Ob}(\mathcal{C})$. For instance, the linear version of the category \mathcal{A} of Jacobi diagrams (see Remark 3.5) admits an infinitesimal braiding; see [30, Section XX.5]. Note that (5.16) and (5.17) imply

$$t_{x \otimes y, z} = (P_{y, x} \otimes \text{id}_z)(\text{id}_y \otimes t_{x, z})(P_{x, y} \otimes \text{id}_z) + \text{id}_x \otimes t_{y, z}. \quad (5.18)$$

Let H be a cocommutative Hopf algebra in \mathcal{C} . A H -module (x, ρ) is said to be *trivial* if $\rho = \epsilon \otimes \text{id}_x$. An infinitesimal braiding $t_{x, y}$ in the symmetric monoidal category \mathbf{Mod}_H of H -modules is called *strong* if it vanishes whenever x or y is a trivial H -module. The following shows that strength of infinitesimal braiding in module categories is automatic for some underlying symmetric monoidal categories \mathcal{C} , such as the category $\mathbf{Vect}_{\mathbb{K}}$ of vector spaces.

Proposition 5.5. *Let \mathcal{C} be a linear symmetric strict monoidal category. We assume that the functor $\mathcal{C}(I, -): \mathcal{C} \rightarrow \mathbf{Vect}_{\mathbb{K}}$ is faithful, and the tensor product map $\mathcal{C}(I, x) \otimes \mathcal{C}(I, y) \rightarrow \mathcal{C}(I, x \otimes y)$ is surjective for each $x, y \in \text{Ob}(\mathcal{C})$. Then, for every cocommutative Hopf algebra H , every infinitesimal braiding t in \mathbf{Mod}_H is strong.*

Proof. The assumptions on \mathcal{C} imply that the map

$$\tau_{x, y}: \mathcal{C}(x \otimes y, x \otimes y) \longrightarrow \text{Hom}_{\mathbb{K}}(\mathcal{C}(I, x) \otimes \mathcal{C}(I, y), \mathcal{C}(I, x \otimes y))$$

defined by $\tau_{x, y}(a) := (b \otimes c \mapsto a(b \otimes c))$ is injective for $x, y \in \text{Ob}(\mathcal{C})$. Let $x, y \in \text{Ob}(\mathbf{Mod}_H)$ with y being a trivial H -module. Then, for each $b: I \rightarrow x$, $c: I \rightarrow y$ in \mathcal{C} , we have

$$\tau_{x, y}(t_{x, y})(b \otimes c) = t_{x, y}(b \otimes c) = t_{x, y}(\text{id}_x \otimes c)b = (\text{id}_x \otimes c)t_{x, I}b = 0,$$

since c is an H -module morphism and (5.17) implies that $t_{x, I} = 0$ for every infinitesimal braiding. Since $\tau_{x, y}$ is injective, we have $t_{x, y} = 0$. Thus t is strong. \square

We now prove that, given a cocommutative Hopf algebra H in \mathcal{C} , there is a one-to-one correspondence between Casimir 2-tensors for H and strong infinitesimal braidings in \mathbf{Mod}_H . This result generalizes [30, Proposition XX.4.2], where $\mathcal{C} = \mathbf{Vect}_{\mathbb{K}}$. Let $H^l := (H, \mu) \in \mathbf{Mod}_H$, the regular representation of H .

Proposition 5.6. *Let H be a cocommutative Hopf algebra in a linear symmetric strict monoidal category \mathcal{C} .*

- (a) *Every Casimir 2-tensor for H induces a strong infinitesimal braiding in \mathbf{Mod}_H defined by*

$$t_{x,y} = (\rho_x \otimes \rho_y)(\text{id}_H \otimes P_{H,x} \otimes \text{id}_y)(c \otimes \text{id}_x \otimes \text{id}_y): x \otimes y \longrightarrow x \otimes y \quad (5.19)$$

for H -modules $x = (x, \rho_x)$ and $y = (y, \rho_y)$.

- (b) *Every strong infinitesimal braiding t in \mathbf{Mod}_H induces a Casimir 2-tensor*

$$c := t_{H^l, H^l}(\eta \otimes \eta): I \longrightarrow H \otimes H \quad (5.20)$$

for H in \mathcal{C} and $t_{x,y}$ is of the form (5.19) for each $x, y \in \mathbf{Mod}_H$.

Proof. We only sketch the proof of (a), leaving the details to the reader. It is easy to check (5.16) and (5.17). Naturality of t , i.e., $t_{x',y'}(f \otimes g) = (f \otimes g)t_{x,y}$ for $f: x \rightarrow x'$ and $g: y \rightarrow y'$ in \mathbf{Mod}_H , follows from the definition of H -module morphisms. We can check that $t_{x,y}$ is an H -module morphism by using (5.14) and the definition of H -modules. Using $(\epsilon \otimes \text{id})c = 0 = (\text{id} \otimes \epsilon)c$, we see that $t_{x,y}$ is a strong infinitesimal braiding.

We now prove (b). We first verify (5.19). Note that for each H -module $x = (x, \rho_x)$, the action ρ_x gives a morphism $\rho_x: H^l \otimes x^\epsilon \rightarrow x$ in \mathbf{Mod}_H , where $x^\epsilon := (x, \epsilon \otimes \text{id}_x)$ is the trivial H -module. Therefore, the naturality of t implies that

$$\begin{aligned} t_{x,y} &= t_{x,y}(\rho_x \otimes \rho_y)(\eta \otimes \text{id}_x \otimes \eta \otimes \text{id}_y) \\ &= (\rho_x \otimes \rho_y)t_{H^l \otimes x^\epsilon, H^l \otimes y^\epsilon}(\eta \otimes \text{id}_x \otimes \eta \otimes \text{id}_y). \end{aligned} \quad (5.21)$$

Using (5.17) and (5.18), we can express $t_{H^l \otimes x^\epsilon, H^l \otimes y^\epsilon}$ as a sum of four morphisms involving t_{H^l, H^l} , t_{H^l, y^ϵ} , t_{x^ϵ, H^l} and $t_{x^\epsilon, y^\epsilon}$, with the last three being 0 since t is strong. Hence,

$$t_{H^l \otimes x^\epsilon, H^l \otimes y^\epsilon} = (\text{id}_H \otimes P_{H,x} \otimes \text{id}_y)(t_{H^l, H^l} \otimes \text{id}_x \otimes \text{id}_y)(\text{id}_H \otimes P_{x,H} \otimes \text{id}_y).$$

This and (5.21) imply (5.19).

We now check the axioms of a Casimir 2-tensor for c . We easily obtain (5.9) from (5.16). The identity (5.8) follows from (5.18) since $\Delta: H^l \rightarrow H^l \otimes H^l$ is a morphism of H -modules. It remains to verify (5.10) or, equivalently, (5.14). Since t_{H^l, H^l} is a morphism in \mathbf{Mod}_H , we have

$$\begin{aligned} &(\mu \otimes \mu)(\text{id} \otimes P \otimes \text{id})(\Delta \otimes \text{id} \otimes \text{id})(\text{id} \otimes t_{H^l, H^l}) \\ &= t_{H^l, H^l}(\mu \otimes \mu)(\text{id} \otimes P \otimes \text{id})(\Delta \otimes \text{id} \otimes \text{id}) \end{aligned}$$

and, by pre-composing with $\text{id} \otimes \eta \otimes \eta$, we obtain $\Delta * c\epsilon = t_{H^l, H^l} \Delta$. Moreover, (5.19) with $x = y = H^l$ implies $t_{H^l, H^l} \Delta = c\epsilon * \Delta$. Hence (5.14). \square

Remark 5.7. It is *not* possible to generalize Proposition 5.6(b) to infinitesimal braidings that are not strong. Here is a counterexample. Let \mathcal{C} be a linear symmetric strict monoidal category equipped with a non-zero infinitesimal braiding t . Consider the *trivial* Hopf algebra in \mathcal{C} , defined by $H = I$ with $\mu = \eta = \Delta = \epsilon = S = \text{id}_I$. Then t is an infinitesimal braiding in \mathbf{Mod}_I via the canonical isomorphism $\mathbf{Mod}_I \cong \mathcal{C}$. Since every I -module is trivial, t is not strong in \mathbf{Mod}_I . However, the Casimir 2-tensor c for I given in (5.20) is zero since $I^l = (I, \text{id}_I)$ is the monoidal unit of $\mathbf{Mod}_I \cong \mathcal{C}$. Therefore, c and t are not related by (5.19).

5.5. Casimir elements. Now we give an alternative viewpoint on Casimir 2-tensors. Let H be a cocommutative Hopf algebra in a linear symmetric strict monoidal category \mathcal{C} .

Definition 5.8. A *Casimir element* for H is a morphism $r: I \rightarrow H$ which is *central* and *quadratic*:

$$\mu(\text{id} \otimes r) = \mu(r \otimes \text{id}), \quad (5.22)$$

$$r_{123} - r_{12} - r_{13} - r_{23} + r_1 + r_2 + r_3 = 0, \quad (5.23)$$

$$Sr = r, \quad (5.24)$$

where

$$\begin{aligned} r_{123} &:= \Delta^{[3]}r, & r_{12} &:= \Delta r \otimes \eta, & r_{13} &:= (\text{id} \otimes \eta \otimes \text{id})\Delta r, & r_{23} &:= \eta \otimes \Delta r, \\ r_1 &:= r \otimes \eta \otimes \eta, & r_2 &:= \eta \otimes r \otimes \eta, & r_3 &:= \eta \otimes \eta \otimes r. \end{aligned}$$

The notion of a Casimir Hopf algebra is equivalent to that of a cocommutative Hopf algebra with a Casimir element, as follows.

Proposition 5.9. *There is a one-to-one correspondence*

$$\{\text{Casimir 2-tensors for } H\} \begin{array}{c} \xrightarrow{c \mapsto r_c} \\ \xleftrightarrow{\quad} \\ \xleftarrow{c_r \leftarrow r} \end{array} \{\text{Casimir elements for } H\}, \quad (5.25)$$

associating to a Casimir 2-tensor c a Casimir element

$$r_c := \frac{1}{2}\mu c: I \longrightarrow H, \quad (5.26)$$

and to a Casimir element r a Casimir 2-tensor

$$c_r := \Delta r - r \otimes \eta - \eta \otimes r: I \longrightarrow H \otimes H. \quad (5.27)$$

Proof. Let c be a Casimir 2-tensor. Let $r = r_c$. We have (5.24) by (5.9) and (5.13). Post-composing $\mu(\text{id} \otimes S)$ to (5.14) gives $r\epsilon = \text{id} * r\epsilon * S$; taking $(-)*\text{id}$, we obtain $r\epsilon * \text{id} = \text{id} * r\epsilon$, equivalent to (5.22). Finally, (5.23) follows from

$$\begin{aligned} r_{123} &= r_1 + r_2 + r_3 + c_{12} + c_{13} + c_{23}, \\ r_{ij} &= r_i + r_j + c_{ij} \quad (1 \leq i < j \leq 3). \end{aligned}$$

Therefore $r = r_c$ is a Casimir element.

Now let r be a Casimir element. Set $c = c_r$. Then (5.8) follows from (5.23), and (5.9) follows from the cocommutativity of H . Moreover, (5.14) follows from (5.22). Hence $c = c_r$ is a Casimir 2-tensor.

If c is a Casimir 2-tensor, then $c_{(r_c)} = c$ follows from (5.8) and (5.9). If r is a Casimir element, then

$$\begin{aligned} r_{(c_r)} &\stackrel{(5.13)}{=} r_{(-(\text{id} \otimes S)c_r)} \\ &\stackrel{(5.26)}{=} -\frac{1}{2}\mu(\text{id} \otimes S)c_r \\ &\stackrel{(5.27)}{=} -\frac{1}{2}(\mu(\text{id} \otimes S)\Delta r - \mu(\text{id} \otimes S)(r \otimes \eta) - \mu(\text{id} \otimes S)(\eta \otimes r)) \\ &= -\frac{1}{2}(\eta\epsilon r - r - Sr) \stackrel{(8.4)}{=} \frac{1}{2}(r + Sr) \stackrel{(5.24)}{=} r. \quad \square \end{aligned}$$

5.6. Presentation of \mathbf{A} . Recall from Section 4.3 that \mathbf{A} is a linear symmetric monoidal category. Define morphisms in \mathbf{A}

$$\begin{aligned} \eta = \begin{array}{c} \square \\ \downarrow \text{---} \uparrow \\ \downarrow \end{array} : 0 \longrightarrow 1, & \quad \mu = \begin{array}{c} \text{---} \uparrow \text{---} \\ \downarrow \end{array} : 2 \longrightarrow 1, \\ \epsilon = \begin{array}{c} \uparrow \text{---} \downarrow \\ \square \end{array} : 1 \longrightarrow 0, & \quad \Delta = \begin{array}{c} \downarrow \text{---} \downarrow \\ \square \end{array} : 1 \longrightarrow 2, \\ S = \begin{array}{c} \uparrow \text{---} \downarrow \\ \downarrow \end{array} : 1 \longrightarrow 1, & \quad c = \begin{array}{c} \text{---} \text{---} \text{---} \\ \downarrow \end{array} : 0 \longrightarrow 2. \end{aligned} \tag{5.28}$$

Proposition 5.10. *We have a Casimir Hopf algebra $(1, \eta, \mu, \epsilon, \Delta, S, c)$ in \mathbf{A} .*

Proof. One can easily verify the axioms of a Hopf algebra. (In fact, this can also be checked by reducing up to homotopy the topological arguments given in [25] for the category \mathcal{B} . See also [24] for related algebraic arguments in the symmetric monoidal category \mathbf{F} of finitely generated free groups.) The cocommutativity follows from

$$P\Delta = \Delta$$

where we write $P = P_{1,1}$.

Now we check for c the relations (5.8), (5.9) and (5.14) of a Casimir 2-tensor. We have (5.8):

$$\begin{aligned}
 (\Delta \otimes \text{id})c &= \text{[Diagram: Box with two crossings, a loop on the top strand, and a dashed arc above the crossings]} \\
 &= \text{[Diagram: Box with three strands, a dashed arc above the first two strands]} + \text{[Diagram: Box with three strands, a dashed arc above the last two strands]} = c_{13} + c_{23}.
 \end{aligned}$$

We have (5.9):

$$Pc = c.$$

We have (5.14):

$$\Delta * c\epsilon = (\mu \otimes \mu)(\text{id} \otimes P \otimes \text{id})(\Delta \otimes c)$$

$$\begin{aligned}
 &= \text{[Diagram: Box with two crossings, a loop on the top strand, and a dashed arc above the crossings]} \\
 &= \text{[Diagram: Box with two crossings, a loop on the top strand, and a dashed arc above the crossings]} \\
 &= (\mu \otimes \mu)(\text{id} \otimes P \otimes \text{id})(c \otimes \Delta) = c\epsilon * \Delta.
 \end{aligned}$$

□

Let H denote the cocommutative Hopf algebra $(1, \mu, \eta, \Delta, \epsilon, S)$ in \mathbf{A} . We prove the following theorem in the rest of this section.

Theorem 5.11. *As a linear symmetric strict monoidal category, \mathbf{A} is free on the Casimir Hopf algebra (H, c) .*

Remark 5.12. Hinich and Vaintrob [29] proved that the algebra $\mathcal{A}(\mathcal{C})$ of chord diagrams on a circle (i.e., the target of the usual Kontsevich integral of knots) is in some sense the “universal enveloping algebra” of the generating object in the linear PROP governing “Casimir Lie algebras”. This gives a universal property for the space $\mathbf{A}(0, 1) \cong \mathcal{A}(\mathcal{C})$, whereas Theorem 1.7 gives a universal property for the entire category \mathbf{A} .

5.7. The category \mathbf{P} generated by a Casimir Hopf algebra. Let \mathbf{P} be the free linear symmetric strict monoidal category on a Casimir Hopf algebra $(P, c) = (P, \mu, \eta, \Delta, \epsilon, S, c)$. Thus, as a linear symmetric strict monoidal category, \mathbf{P} is generated by the object P and the morphisms $\mu, \eta, \Delta, \epsilon, S$ and c , and all the relations in \mathbf{P} are derived from the axioms of a linear symmetric monoidal category and the relations (5.1)–(5.5) and (5.8)–(5.10). In other words, \mathbf{P} is the linear PROP (see [48]) governing Casimir Hopf algebras. Define a grading of \mathbf{P} by

$$\deg(\mu) = \deg(\eta) = \deg(\Delta) = \deg(\epsilon) = \deg(S) = 0, \quad \deg(c) = 1.$$

For $m \geq 0$, we identify the object $P^{\otimes m}$ with m .

The category \mathbf{P} has the following universal property. If \mathcal{C} is a linear symmetric strict monoidal category and (H, c) is a Casimir Hopf algebra in \mathcal{C} , then there is a unique linear symmetric monoidal functor $F = F_{(H,c)}: \mathbf{P} \rightarrow \mathcal{C}$ which maps the Casimir Hopf algebra (P, c) in \mathbf{P} to the Casimir Hopf algebra (H, c) in \mathcal{C} .

Consequently, since \mathbf{A} has a Casimir Hopf algebra (H, c) by Proposition 5.10, there is a unique (graded) linear symmetric monoidal functor

$$F = F_{(H,c)}: \mathbf{P} \longrightarrow \mathbf{A}$$

mapping (P, c) to (H, c) . To prove Theorem 5.11, we need to show that F is an isomorphism.

5.8. The space $W(m, n)$ of tensor words. Let $m, n \geq 0$ be integers. A *tensor word* from m to n of *degree* k is an expression of the form

$$\mathbf{w} = w_1 \otimes \cdots \otimes w_n,$$

where

- for each $i \in \{1, \dots, n\}$, w_i is a word in the symbols

$$\{x_j, x_j^{-1} \mid 1 \leq j \leq m\} \cup \{c'_p, c''_p \mid 1 \leq p \leq k\},$$

- each of c'_p, c''_p ($1 \leq p \leq k$) appears in the concatenated word $w_1 \cdots w_n$ exactly once.

In this case we write $\mathbf{w}: m \rightarrow n$. For example,

$$\mathbf{w} = x_1 c'_1 c'_2 \otimes c'_3 c''_1 c''_3 x_2 \otimes x_1^{-1} c''_2 x_2 x_1 : 2 \longrightarrow 3 \quad (5.29)$$

is a tensor word of degree 3. As we will see below, the symbols $x_j^{\pm 1}$ may be considered as elements of the free group F_n on x_1, \dots, x_n .

Two tensor words $\mathbf{w}, \mathbf{w}': m \rightarrow n$ are *equivalent* if they have the same degree k and they are related by a permutation of $\{1, \dots, k\}$. For example, the above \mathbf{w} is equivalent to the tensor word

$$(12)\mathbf{w} := x_1 c'_2 c'_1 \otimes c'_3 c''_2 c''_3 x_2 \otimes x_1^{-1} c''_1 x_2 x_1 : 2 \longrightarrow 3$$

obtained from \mathbf{w} by exchanging (c'_1, c''_1) and (c'_2, c''_2) . Let $[\mathbf{w}]$ denote the equivalence class of \mathbf{w} . Let $\tilde{W}(m, n)$ denote the vector space with basis consisting of equivalence classes of tensor words from m to n .

Let $W(m, n)$ denote the quotient space of $\tilde{W}(m, n)$ by the subspace generated by the following elements:

- (*chord orientation*) $[\mathbf{w}] - [\mathbf{w}']$, where \mathbf{w} and \mathbf{w}' differ by interchanging c'_p and c''_p for some p ,
- (*cancellation*) $[\mathbf{w}] - [\mathbf{w}']$, where \mathbf{w} and \mathbf{w}' differ locally as

$$\begin{aligned} \mathbf{w} &= (\cdots x_i^{\pm 1} x_i^{\mp 1} \cdots), \\ \mathbf{w}' &= (\cdots \quad \quad \quad \cdots), \end{aligned}$$

for some i ,

- (*bead slide*) $[\mathbf{w}] - [\mathbf{w}']$, where \mathbf{w} and \mathbf{w}' differ locally as

$$\begin{aligned} \mathbf{w} &= (\cdots x_i c'_p \cdots x_i c''_p \cdots), \\ \mathbf{w}' &= (\cdots c'_p x_i \cdots c''_p x_i \cdots), \end{aligned}$$

for some i and p ,

- (*4T*) $[\mathbf{w}_1] - [\mathbf{w}_2] - [\mathbf{w}_3] + [\mathbf{w}_4]$ and $[\mathbf{w}_1] - [\mathbf{w}_2] - [\mathbf{w}_5] + [\mathbf{w}_6]$, where $\mathbf{w}_1, \dots, \mathbf{w}_6$ differ locally as

$$\mathbf{w}_1 = (\cdots c'_i \cdots c''_i c'_i \cdots c''_i \cdots),$$

$$\begin{aligned}
 \mathbf{w}_2 &= (\cdots c'_i \cdots c'_{i'} c''_i \cdots c''_{i'} \cdots), \\
 \mathbf{w}_3 &= (\cdots c'_i \cdots c'_{i'} \cdots c''_{i'} c''_i \cdots), \\
 \mathbf{w}_4 &= (\cdots c'_i \cdots c'_{i'} \cdots c''_i c''_{i'} \cdots), \\
 \mathbf{w}_5 &= (\cdots c'_i c'_{i'} \cdots c''_{i'} \cdots c''_i \cdots), \\
 \mathbf{w}_6 &= (\cdots c'_{i'} c'_i \cdots c''_i \cdots c''_{i'} \cdots).
 \end{aligned}$$

for some i, i' with $i \neq i'$.

In the above expressions, each \cdots means a subexpression of a tensor word possibly containing the tensor signs.

5.9. The isomorphism $\tau: W(m, n) \rightarrow \mathbf{A}(m, n)$. By an *admissible chord diagram* from m to n of degree k we mean a restricted F_m -colored chord diagram D on $X_n = \bigcap_1 \cdots \bigcap_n$ with k chords, with each bead in D labelled by one of $x_1^{\pm 1}, \dots, x_m^{\pm 1}$.

We define a linear map

$$\tilde{\tau}: \tilde{W}(m, n) \longrightarrow \mathbf{A}(m, n)$$

as follows. Given a tensor word $\mathbf{w} = w_1 \otimes \cdots \otimes w_n: m \rightarrow n$ of degree k , put the symbols appearing in each w_i on the i th strand \bigcap_i (in the order inverse to the orientation) and, for each $j = 1, \dots, k$, connect the two points labelled by c'_j and c''_j with a chord. Then we obtain an admissible chord diagram $\tilde{\tau}(\mathbf{w})$, regarded as an element of $\mathbf{A}_k(m, n)$. For example, for \mathbf{w} in (5.29) we have

$$\tilde{\tau}(\mathbf{w}) = \boxed{
 \begin{array}{c}
 \text{Diagram with strands } x_1, x_2, x_1^{-1}, x_2 \text{ and chords } c'_i, c''_i \text{ connected by dashed arcs.} \\
 \text{Labels: } x_1, c'_1, c'_2, c''_3, c''_1, c''_3, x_2, x_1^{-1}, c''_2, x_2, x_1
 \end{array}
 } \quad (5.30)$$

Lemma 5.13. *The map $\tilde{\tau}$ is surjective, and induces an isomorphism*

$$\tau: W(m, n) \longrightarrow \mathbf{A}(m, n).$$

Proof. The lemma follows directly from the isomorphism $u^{\text{ch}}: \mathcal{A}^{\text{ch},r}(X_n, F_m) \rightarrow \mathcal{A}^{\text{ch}}(X_n, F_m)$ obtained in Theorem 4.4. \square

5.10. The map $\alpha: W(m, n) \rightarrow \mathbf{P}(m, n)$. We will assign to every tensor word $\mathbf{w}: m \rightarrow n$ of degree k a morphism $\tilde{\alpha}(\mathbf{w}): m \rightarrow n$ in \mathbf{P} of degree k . For example,

for the tensor word $\mathbf{w}: 2 \rightarrow 3$ of degree 3 in (5.29), corresponding to the admissible chord diagram $\tilde{\tau}(\mathbf{w})$ in (5.30), we have graphically

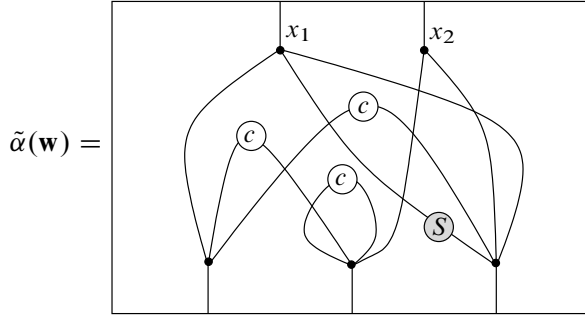

In general, the diagram representing $\tilde{\alpha}(\mathbf{w})$ has m edges e_1, \dots, e_m at the top (corresponding to the generators x_1, \dots, x_m) and n edges e'_1, \dots, e'_n at the bottom. For each $j = 1, \dots, n$, the bottom edge e'_j is locally attached to l'_j input edges, where l'_j is the length of w_j . In our example, we have $(l'_1, l'_2, l'_3) = (3, 4, 4)$. For each $i = 1, \dots, m$, the top edge e_i is locally attached to as many output edges as the number l_i of occurrences of $x_i^{\pm 1}$ in \mathbf{w} . In our example, we have $(l_1, l_2) = (3, 2)$. Moreover, the diagram contains k “caps” labelled by c encoding k copies of $c: 0 \rightarrow 2$. Each “cap” has two output ends. The outputs of top edges, the inputs of bottom edges and the outputs of “caps” are connected by using the following rules.

- If the r th symbol in w_j ($1 \leq j \leq n$, $1 \leq r \leq l'_j$) is x_i^ϵ ($\epsilon = \pm 1$), then the r th input at e'_j is connected by an arc to one of the outputs of e_i . If $\epsilon = -1$ here, then a label S is added to the arc to encode the antipode $S: 1 \rightarrow 1$.
- If the r th symbol in w_j ($1 \leq j \leq n$, $1 \leq r \leq l'_j$) is c'_p (resp. c''_p), with $1 \leq p \leq k$, then the r th input at e'_j is connected by an arc to the left (resp. right) output of the p th “cap”.

We interpret the diagram thus obtained as a morphism in \mathbf{P} in the usual way. At the top we have the tensor product of m multi-output comultiplications, and at the bottom we have the tensor product of n multi-input multiplications.

These rules yield a well-defined morphism $\tilde{\alpha}(\mathbf{w}): m \rightarrow n$ in \mathbf{P} . Indeed, the only possible ambiguities are the ordering of the outputs at each top edge, the positions of the “caps” between the top and bottom, and the choices of the connecting arcs. Independence of $\tilde{\alpha}(\mathbf{w})$ from those choices follows from the cocommutativity of \mathbf{P} and the general properties of symmetric monoidal categories. Thus we obtain a linear map

$$\tilde{\alpha}: \tilde{W}(m, n) \longrightarrow \mathbf{P}(m, n)$$

defined by $\mathbf{w} \mapsto \alpha(\mathbf{w})$ on generators.

Lemma 5.14. *The map $\tilde{\alpha}$ induces a linear map $\alpha: W(m, n) \rightarrow \mathbf{P}(m, n)$.*

Proof. It suffices to check that each of the relations defining the vector space $W(m, n)$ as a quotient of $\tilde{W}(m, n)$ in Section 5.8 is mapped to 0 in \mathbf{P} . Indeed,

- the “chord orientation” relation is mapped to 0 because of the symmetry axiom (5.9),
- the “cancellation” relation is mapped to 0 because of the antipode relation (5.4),
- the “bead slide” relation is mapped to 0 because of (5.14),
- the “4T” relation is mapped to 0 because of (5.15). □

5.11. Surjectivity of α . For $n \geq 0$, let \mathfrak{S}_n denote the symmetric group of order n . Define a homomorphism

$$\mathfrak{S}_n \longrightarrow \mathbf{P}(n, n), \quad \sigma \longmapsto P_\sigma \tag{5.31}$$

by $P_{(i, i+1)} = \text{id}_{i-1} \otimes P_{1,1} \otimes \text{id}_{n-i-1}$ for $i \in \{1, \dots, n-1\}$. Set

$$\mu^{[q_1, \dots, q_n]} = \mu^{[q_1]} \otimes \dots \otimes \mu^{[q_n]}, \quad \Delta^{[p_1, \dots, p_m]} = \Delta^{[p_1]} \otimes \dots \otimes \Delta^{[p_m]},$$

for $q_1, \dots, q_n, p_1, \dots, p_m \geq 0$.

Lemma 5.15. *Let $m, n \geq 0$. Every homogeneous element of $\mathbf{P}(m, n)$ of degree k is a linear combination of morphisms of the form*

$$\begin{aligned} & \mu^{[q_1, \dots, q_n]} P_\sigma (S^{e_1} \otimes \dots \otimes S^{e_s} \otimes \text{id}_{2k}) (\text{id}_s \otimes c^{\otimes k}) \Delta^{[p_1, \dots, p_m]} \\ & = \mu^{[q_1, \dots, q_n]} P_\sigma ((S^{e_1} \otimes \dots \otimes S^{e_s}) \Delta^{[p_1, \dots, p_m]} \otimes c^{\otimes k}), \end{aligned} \tag{5.32}$$

where $s, p_1, \dots, p_m, q_1, \dots, q_n \geq 0$ with $s = p_1 + \dots + p_m = q_1 + \dots + q_n - 2k$, $e_1, \dots, e_s \in \{0, 1\}$ and $\sigma \in \mathfrak{S}_{s+2k}$.

Proof. We adapt the proof of [24, Lemma 2]. The main difference here is that our category is a linear category, and we have an extra morphism c .

Let \mathbf{P}^0 (resp. \mathbf{P}^+ , \mathbf{P}^- , \mathbf{P}^c) denote the linear monoidal subcategory of \mathbf{P} generated by the object 1 and the set of morphisms $\{P_{1,1}, S\}$ (resp. $\{\mu, \eta\}$, $\{\Delta, \epsilon\}$, $\{c\}$). We also use the symbol \mathbf{P}^* (with $*$ = 0, +, −, c) to denote the set $\coprod_{m, n \geq 0} \mathbf{P}^*(m, n)$.

We will consider compositions of such spaces. For instance, $\mathbf{P}^+ \mathbf{P}^0$ denotes the subset of \mathbf{P} consisting of all well-defined linear combinations of compositions $f^+ f^0$ of composable pairs of morphisms $f^+ \in \mathbf{P}^+$ and $f^0 \in \mathbf{P}^0$.

First, we will prove

$$\mathbf{P} = \mathbf{P}^+ \mathbf{P}^0 \mathbf{P}^c \mathbf{P}^-. \quad (5.33)$$

For $i \geq 0$, let \mathbf{P}_i denote the degree i part of \mathbf{P} . If $i > 0$, then \mathbf{P}_i is the product $\mathbf{P}_1 \cdots \mathbf{P}_1$ of i copies of \mathbf{P}_1 . Set $\mathbf{P}_i^c = \mathbf{P}^c \cap \mathbf{P}_i$. Note that \mathbf{P}_0 is the linear symmetric monoidal subcategory of \mathbf{P} generated by $\mu, \eta, \Delta, \epsilon, S$. Thus, the proof of [24, Lemma 2] gives

$$\mathbf{P}^- \mathbf{P}^+ \subset \mathbf{P}^+ \mathbf{P}^0 \mathbf{P}^-, \quad \mathbf{P}^0 \mathbf{P}^+ \subset \mathbf{P}^+ \mathbf{P}^0, \quad \mathbf{P}^- \mathbf{P}^0 \subset \mathbf{P}^0 \mathbf{P}^-, \quad (5.34)$$

$$\mathbf{P}_0 = \mathbf{P}^+ \mathbf{P}^0 \mathbf{P}^-. \quad (5.35)$$

For \mathbf{P}^c , we have

$$\mathbf{P}^c \mathbf{P}^+ \subset \mathbf{P}^+ \mathbf{P}^c, \quad \mathbf{P}^c \mathbf{P}^0 \subset \mathbf{P}^0 \mathbf{P}^c, \quad (5.36)$$

$$\mathbf{P}^- \mathbf{P}^c \subset \mathbf{P}^+ \mathbf{P}^0 \mathbf{P}^c \mathbf{P}^-. \quad (5.37)$$

Here (5.36) easily follows. To prove (5.37), we use

$$\mathbf{P}^- \mathbf{P}_1^c \subset \mathbf{P}^+ \mathbf{P}^0 \mathbf{P}_1^c \mathbf{P}^-,$$

which we can check using (5.8) and (5.11)–(5.12). Then, proceeding by induction on $i \geq 1$ and using (5.34)–(5.36), we obtain $\mathbf{P}^- \mathbf{P}_i^c \subset \mathbf{P}^+ \mathbf{P}^0 \mathbf{P}_i^c \mathbf{P}^-$. This implies (5.37).

Using the inclusions obtained so far, we can check that $\mathbf{P}^+ \mathbf{P}^0 \mathbf{P}^c \mathbf{P}^-$ is closed under composition, i.e.,

$$(\mathbf{P}^+ \mathbf{P}^0 \mathbf{P}^c \mathbf{P}^-)(\mathbf{P}^+ \mathbf{P}^0 \mathbf{P}^c \mathbf{P}^-) \subset \mathbf{P}^+ \mathbf{P}^0 \mathbf{P}^c \mathbf{P}^-.$$

Since $\mathbf{P}^+ \mathbf{P}^0 \mathbf{P}^c \mathbf{P}^-$ contains the identity morphisms, it is a linear subcategory of \mathbf{P} . Since $\mathbf{P}^+ \mathbf{P}^0 \mathbf{P}^c \mathbf{P}^-$ contains $\mathbf{P}^+, \mathbf{P}^0, \mathbf{P}^c$ and \mathbf{P}^- , we obtain (5.33).

Let $k \geq 0$. Homogeneous elements of $\mathbf{P}^0 \mathbf{P}^c$ of degree k are linear combinations of morphisms of the form

$$(S^{e_1} \otimes \cdots \otimes S^{e_{s+2k}}) P_\sigma (\text{id}_s \otimes c^{\otimes k}),$$

where $s \geq 0$, $e_1, \dots, e_{s+2k} \in \{0, 1\}$ and $\sigma \in \mathfrak{S}_{s+2k}$. Thus, by (5.33), every homogeneous element of $\mathbf{P}(m, n)$ of degree k is a linear combination of morphisms of the form

$$\mu^{[q_1, \dots, q_n]} P_\sigma (S^{e_1} \otimes \cdots \otimes S^{e_{s+2k}}) (\text{id}_s \otimes c^{\otimes k}) \Delta^{[p_1, \dots, p_m]}, \quad (5.38)$$

where $p_1, \dots, p_m, q_1, \dots, q_n \geq 0$ are such that $p_1 + \dots + p_m = q_1 + \dots + q_n - 2k$, $s := p_1 + \dots + p_m$, $e_1, \dots, e_{s+2k} \in \{0, 1\}$ and $\sigma \in \mathfrak{S}_{s+2k}$. Since (5.13) gives

$$(S^{e_1} \otimes \dots \otimes S^{e_{s+2k}})(\text{id}_s \otimes c^{\otimes k}) = \pm (S^{e_1} \otimes \dots \otimes S^{e_s} \otimes \text{id}_{2k})(\text{id}_s \otimes c^{\otimes k}),$$

a morphism of the form (5.38) is, up to sign, also of the form (5.32). \square

Lemma 5.16. *The linear map $\alpha: W(m, n) \rightarrow \mathbf{P}(m, n)$ is surjective.*

Proof. Let $f: m \rightarrow n$ in \mathbf{P} be as in (5.32). Define a tensor word $\mathbf{w}: m \rightarrow n$ by

$$\mathbf{w} = u_1 \cdots u_{q_1} \otimes u_{q_1+1} \cdots u_{q_1+q_2} \otimes \cdots \otimes u_{q_1+\dots+q_{n-1}+1} \cdots u_{q_1+\dots+q_{n-1}+q_n},$$

where $u_j := v_{\sigma^{-1}(j)}$ with

$$v_j := \begin{cases} x_{a(j)}^{(-1)^{e_j}} & (j = 1, \dots, s), \\ c'_{(j-s+1)/2} & (j = s+1, s+3, \dots, s+2k-1), \\ c''_{(j-s)/2} & (j = s+2, s+4, \dots, s+2k) \end{cases}$$

for $j = 1, \dots, q_1 + \dots + q_n$. Here we define the map $a: \{1, \dots, s\} \rightarrow \{1, \dots, m\}$ by

$$a(j) = \max\{a \in \{1, \dots, m\} \mid j \leq p_1 + \dots + p_a\}.$$

Then one can check $\alpha([\mathbf{w}]) = f$. Hence, by Lemma 5.15, α is surjective. \square

5.12. Proof of Theorem 5.11. Let $m, n \geq 0$. Consider the diagram

$$\begin{array}{ccc} \mathbf{P}(m, n) & \xrightarrow{F} & \mathbf{A}(m, n) \\ & \searrow \alpha & \nearrow \tau \cong \\ & W(m, n) & \end{array} \quad (5.39)$$

By Lemma 5.13, τ is an isomorphism and, by Lemma 5.16, α is surjective. Thus, to prove that F is an isomorphism it suffices to prove that the diagram (5.39) commutes.

We have factorization of morphisms in \mathbf{A} similar to Lemma 5.15 for \mathbf{P} .

Lemma 5.17. *Every homogeneous element of $\mathbf{A}(m, n)$ of degree k is a linear combination of morphisms of the form*

$$f = \mu^{[q_1, \dots, q_n]} P_\sigma (S^{e_1} \otimes \dots \otimes S^{e_s} \otimes \text{id}_{2k})(\text{id}_s \otimes c^{\otimes k}) \Delta^{[p_1, \dots, p_m]}, \quad (5.40)$$

where $s, p_1, \dots, p_m, q_1, \dots, q_n \geq 0$ with $s = p_1 + \dots + p_m = q_1 + \dots + q_n - 2k$, $e_1, \dots, e_s \in \{0, 1\}$ and $\sigma \in \mathfrak{S}_{s+2k}$.

Proof. This follows from the surjectivity of $\tau: W(m, n) \rightarrow \mathbf{A}(m, n)$. \square

Now one can easily see that, for every $f \in \mathbf{A}(m, n)$ of degree k decomposed as in (5.40), we have $F\alpha\tau^{-1}(f) = f$. Hence the diagram (5.39) commutes. This completes the proof of Theorem 5.11.

6. A ribbon quasi-Hopf algebra in $\widehat{\mathbf{A}}$

In this section, we construct a ribbon quasi-Hopf algebra in $\widehat{\mathbf{A}}$ for each choice of a Drinfeld associator.

6.1. Ribbon quasi-Hopf algebras. We recall the notions of quasi-triangular and ribbon quasi-Hopf algebras in symmetric monoidal categories. See [30] for an introduction to quasi-triangular quasi-Hopf algebras, and see [2, 60] for their ribbon versions.

Let \mathcal{C} be a (possibly linear) symmetric strict monoidal category with monoidal unit I and symmetry $P_{X,Y}: X \otimes Y \rightarrow Y \otimes X$. Let (H, μ, η) be an algebra in \mathcal{C} . We defined the convolution product $*$ on $\mathcal{C}(I, H^{\otimes n})$ in (5.7). For $X \in \text{Ob}(\mathcal{C})$, we can extend $*$ to

$$\begin{aligned} *: \mathcal{C}(I, H^{\otimes n}) \times \mathcal{C}(X, H^{\otimes n}) &\longrightarrow \mathcal{C}(X, H^{\otimes n}), & g * f &:= \mu_n(g \otimes f), \\ *: \mathcal{C}(X, H^{\otimes n}) \times \mathcal{C}(I, H^{\otimes n}) &\longrightarrow \mathcal{C}(X, H^{\otimes n}), & f * h &:= \mu_n(f \otimes h). \end{aligned}$$

Thus, the convolution monoid $\mathcal{C}(I, H^{\otimes n})$ acts on $\mathcal{C}(X, H^{\otimes n})$ from both left and right. These actions commute, i.e., $(g * f) * h = g * (f * h)$.

A *quasi-bialgebra* H in \mathcal{C} is an algebra (H, μ, η) equipped with morphisms of algebras

$$\Delta: H \longrightarrow H \otimes H, \quad \epsilon: H \longrightarrow I,$$

and a convolution-invertible morphism

$$\varphi: I \longrightarrow H^{\otimes 3}$$

such that

$$(\epsilon \otimes \text{id})\Delta = \text{id} = (\text{id} \otimes \epsilon)\Delta, \tag{6.1}$$

$$(\text{id} \otimes \Delta)\Delta = \varphi * (\Delta \otimes \text{id})\Delta * \varphi^{-1}, \tag{6.2}$$

$$(\text{id} \otimes \varphi) * (\text{id} \otimes \Delta \otimes \text{id})\varphi * (\varphi \otimes \text{id}) = (\text{id} \otimes \text{id} \otimes \Delta)\varphi * (\Delta \otimes \text{id} \otimes \text{id})\varphi, \tag{6.3}$$

$$(\text{id} \otimes \epsilon \otimes \text{id})\varphi = \eta \otimes \eta. \tag{6.4}$$

A quasi-bialgebra H is *cocommutative* if $P_{H,H}\Delta = \Delta$, and *special* if we have

$$\mu(\text{id} \otimes x) = \mu(x \otimes \text{id}) \quad \text{for every } x: I \rightarrow H. \quad (6.5)$$

A *quasi-Hopf algebra* is a quasi-bialgebra H equipped with an algebra anti-automorphism

$$S: H \longrightarrow H$$

and convolution-invertible morphisms

$$\alpha, \beta: I \longrightarrow H$$

such that

$$\mu^{[3]}(S \otimes \alpha \otimes \text{id})\Delta = \alpha\epsilon, \quad \mu^{[3]}(\text{id} \otimes \beta \otimes S)\Delta = \beta\epsilon, \quad (6.6)$$

$$\mu^{[5]}(\text{id} \otimes \beta \otimes S \otimes \alpha \otimes \text{id})\varphi = \eta, \quad \mu^{[5]}(S \otimes \alpha \otimes \text{id} \otimes \beta \otimes S)\varphi^{-1} = \eta. \quad (6.7)$$

A quasi-Hopf algebra H is *quasi-triangular* if it is equipped with a convolution-invertible morphism

$$R: I \longrightarrow H \otimes H$$

such that

$$R * \Delta * R^{-1} = P_{H,H}\Delta, \quad (6.8)$$

$$(\Delta \otimes \text{id})R = \varphi_{321} * R_{13} * \varphi_{132}^{-1} * R_{23} * \varphi_{123}, \quad (6.9)$$

$$(\text{id} \otimes \Delta)R = \varphi_{231}^{-1} * R_{13} * \varphi_{213} * R_{12} * \varphi_{123}^{-1}, \quad (6.10)$$

where we set

$$R_{12} = R \otimes \eta, \quad R_{13} = (\text{id} \otimes \eta \otimes \text{id})R, \quad R_{23} = \eta \otimes R$$

and $\varphi_{ijk}^{\pm 1} = P_{(i,j,k)}\varphi^{\pm 1}$. Here $P_\sigma: H^{\otimes 3} \rightarrow H^{\otimes 3}$ for $\sigma \in \mathfrak{S}_3$ is the permutation morphism defined similarly to (5.31). A quasi-triangular quasi-Hopf algebra H is *triangular* if $R_{21} = R$, where we set $R_{21} = P_{H,H}R: I \rightarrow H \otimes H$.

We can view every cocommutative Hopf algebra $(H, \mu, \eta, \Delta, \epsilon, S)$ as a quasi-triangular quasi-Hopf algebra by setting $\varphi = \eta^{\otimes 3}$, $\alpha = \beta = \eta$ and $R = \eta^{\otimes 2}$.

A quasi-triangular quasi-Hopf algebra H is *ribbon* if it admits a convolution-invertible morphism

$$\mathbf{r}: I \longrightarrow H$$

such that

$$S\mathbf{r} = \mathbf{r}, \quad (6.11)$$

$$\Delta\mathbf{r} = R_{21} * R * (\mathbf{r} \otimes \mathbf{r}). \quad (6.12)$$

6.2. Kohno–Drinfeld Lie algebras and associators. We recall the definition of Drinfeld associators.

For $n \geq 0$, the *Kohno–Drinfeld Lie algebra* \mathfrak{t}_n is the Lie algebra over \mathbb{K} generated by t_{ij} ($i, j \in \{1, \dots, n\}, i \neq j$) with relations

$$t_{ij} = t_{ji}, \quad [t_{ij}, t_{ik} + t_{jk}] = 0 \ (i, j, k \text{ distinct}), \quad [t_{ij}, t_{kl}] = 0 \ (i, j, k, l \text{ distinct}).$$

We regard the universal enveloping algebra $U(\mathfrak{t}_n)$ of \mathfrak{t}_n as a subalgebra of the algebra $\mathcal{A}(\downarrow^{\otimes n}) \subset \mathcal{A}(+\otimes^n, +\otimes^n)$ of Jacobi diagrams on $\downarrow^{\otimes n} := \downarrow \cdots \downarrow$, via the injective algebra homomorphism

$$U(\mathfrak{t}_n) \longrightarrow \mathcal{A}(\downarrow^{\otimes n}) \tag{6.13}$$

that maps each t_{ij} to the chord diagram with a chord connecting the i -th and j -th strings. (See [5, Corollary 4.4] or [20, Remark 16.2] for the injectivity of (6.13).)

Let $\mathbb{K}\langle\langle X, Y \rangle\rangle$ denote the algebra of formal power series in two non-commuting generators. As usual, $\mathbb{K}\langle\langle X, Y \rangle\rangle$ is a complete Hopf algebra, with X and Y primitive. A *Drinfeld associator* is a group-like element $\varphi(X, Y) \in \mathbb{K}\langle\langle X, Y \rangle\rangle$ such that

$$\varphi(t_{12}, t_{23} + t_{24})\varphi(t_{13} + t_{23}, t_{34}) = \varphi(t_{23}, t_{34})\varphi(t_{12} + t_{13}, t_{24} + t_{34})\varphi(t_{12}, t_{23}), \tag{6.14}$$

$$\exp\left(\frac{t_{13} + t_{23}}{2}\right) = \varphi(t_{13}, t_{12}) \exp\left(\frac{t_{13}}{2}\right)\varphi(t_{13}, t_{23})^{-1} \exp\left(\frac{t_{23}}{2}\right)\varphi(t_{12}, t_{23}), \tag{6.15}$$

$$\exp\left(\frac{t_{12} + t_{13}}{2}\right) = \varphi(t_{23}, t_{13})^{-1} \exp\left(\frac{t_{13}}{2}\right)\varphi(t_{12}, t_{13}) \exp\left(\frac{t_{12}}{2}\right)\varphi(t_{12}, t_{23})^{-1}. \tag{6.16}$$

Remark 6.1. A Drinfeld associator $\varphi(X, Y)$ gives rise to an associator

$$\Phi := \varphi(t_{12}, t_{23})^{-1} \in \mathcal{A}(\downarrow\downarrow\downarrow)$$

in the sense of Section 3.7.

6.3. A ribbon quasi-Hopf algebra in $\widehat{\mathbf{A}}$. We consider $\mathbf{A}(0, n)$ ($n \geq 0$) as an algebra with the convolution product $*$. We have an algebra isomorphism

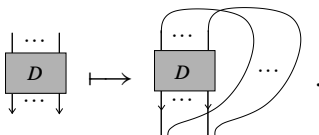
$$\iota: \mathcal{A}(\downarrow^{\otimes n}) \longrightarrow \mathbf{A}(0, n),$$

The diagrammatic equation shows a mapping from a box labeled D with n vertical strings (top and bottom) to another box labeled D with n vertical strings and n loops connecting adjacent strings. The first part of the diagram is a box D with n vertical strings, with three dots above and below. An arrow points to the second part, which is a box D with n vertical strings, with three dots above and below, and n loops connecting adjacent strings. The loops are shown as arcs connecting the top and bottom of adjacent strings.

For $1 \leq i < j \leq n$, set

$$c_{ij} := \iota(t_{ij}) = (\eta^{\otimes(i-1)} \otimes \text{id} \otimes \eta^{\otimes(i-j-1)} \otimes \text{id} \otimes \eta^{\otimes(n-j)})c: 0 \longrightarrow n.$$

Clearly, the cocommutative Hopf algebra structure $(1, \mu, \eta, \Delta, \epsilon, S)$ in \mathbf{A} given in Proposition 5.10 induces a cocommutative Hopf algebra structure in the degree-completion $\widehat{\mathbf{A}}$ of \mathbf{A} .

Let $\varphi(X, Y) \in \mathbb{K}\langle\langle X, Y \rangle\rangle$ be a Drinfeld associator. Define morphisms in $\widehat{\mathbf{A}}$:

$$\varphi = \iota(\varphi(t_{12}, t_{23})) = \varphi(c_{12}, c_{23}): 0 \longrightarrow 3, \quad (6.17)$$

$$R = \iota\left(\exp\left(\frac{1}{2}t_{12}\right)\right) = \exp_*(c/2): 0 \longrightarrow 2, \quad (6.18)$$

$$\mathbf{r} = \iota\left(\exp\left(\frac{1}{2}\begin{array}{c} \circlearrowleft \\ \downarrow \end{array}\right)\right) = \exp_*(\mu c/2): 0 \longrightarrow 1. \quad (6.19)$$

Set $\Phi = \varphi(t_{12}, t_{23})^{-1} \in \mathcal{A}(\downarrow\downarrow\downarrow)$, and define $\nu: 0 \rightarrow 1$ by

$$\nu = \iota\left(\begin{array}{c} \text{---} \\ \uparrow \text{---} \\ \boxed{S_2(\Phi^{-1})} \\ \downarrow \text{---} \\ \text{---} \end{array}\right)^{-1} \quad \text{or, equivalently, by} \quad \nu = \iota\left(\begin{array}{c} \text{---} \\ \uparrow \text{---} \\ \boxed{S_2(\Phi)} \\ \downarrow \text{---} \\ \text{---} \end{array}\right)^{-1} \quad (6.20)$$

where $S_2: \mathcal{A}(\downarrow\downarrow\downarrow) \rightarrow \mathcal{A}(\downarrow\uparrow\downarrow)$ is the diagrammatic ‘‘orientation-reversal operation’’ applied to the second string. (The equivalence of those two definitions of ν follows from $\varphi(t_{23}, t_{12}) = \varphi(t_{12}, t_{23})^{-1}$, which is a consequence of (6.15)–(6.16); see [6, Proposition 3.7].)

Let $\beta: 0 \rightarrow 1$ in $\widehat{\mathbf{A}}$ be convolution-invertible (equivalently, $\epsilon\beta \neq 0$), and let $\alpha = \nu * \beta^{-1}$. We denote

$$H_{\varphi, \beta} = (1, \mu, \eta, \Delta, \epsilon, \varphi, S, \alpha, \beta, R, \mathbf{r}).$$

and, for $\beta = \eta$, we set $H_\varphi = H_{\varphi, \eta}$.

Theorem 6.2. *For each Drinfeld associator $\varphi = \varphi(X, Y)$ and each convolution-invertible $\beta: 0 \rightarrow 1$, $H_{\varphi, \beta}$ is a (triangular, cocommutative, special) ribbon quasi-Hopf algebra in $\widehat{\mathbf{A}}$.*

Proof. To prove that $H_{\varphi, \beta}$ is a ribbon quasi-Hopf algebra, it suffices to check (6.2)–(6.12) since $(1, \mu, \eta, \Delta, \epsilon, S)$ is a Hopf algebra. First, note that

$$\Delta^{[n]} * x = x * \Delta^{[n]} \quad \text{for } n \geq 0 \text{ and } x: 0 \rightarrow n. \quad (6.21)$$

We obtain (6.2) and (6.6) from (6.21). We obtain (6.3) from the pentagon equation (6.14). We obtain (6.4) from $\varphi(0, 0) = 1$, which holds since $\varphi(X, Y)$ is group-like. We obtain (6.7) from (6.21), the well-known identity $S(\iota^{-1}(v)) = \iota^{-1}(v) \in \mathcal{A}(\downarrow)$ and

$$\mu^{[3]}(\text{id} \otimes S \otimes \text{id})\varphi = v^{-1} = \mu^{[3]}(\text{id} \otimes S \otimes \text{id})\varphi_{321}^{-1},$$

which follows from (6.20). We obtain (6.8) from (6.21) and cocommutativity of Δ . We obtain (6.9) and (6.10) from the hexagon equations (6.15) and (6.16). We obtain (6.11) as follows:

$$S\mathbf{r} = S \exp_*(\mu c/2) = \exp_* S(\mu c/2) = \exp_*(\mu(S \otimes S)P_{1,1}c/2) = \mathbf{r}.$$

To obtain (6.12), let us apply to it the algebra isomorphism ι^{-1} . We have

$$\begin{aligned} \iota^{-1}(\Delta\mathbf{r}) &= C_{++}(\iota^{-1}(\mathbf{r})) \\ &= \exp C_{++} \left(\frac{1}{2} \begin{array}{c} \downarrow \\ \circlearrowleft \\ \downarrow \end{array} \right) = \exp \left(\frac{1}{2} \begin{array}{c} \downarrow \\ \text{---} \\ \downarrow \\ \text{---} \\ \downarrow \end{array} \circlearrowleft \right) \\ &= \exp \left(\frac{1}{2} \begin{array}{c} \downarrow \\ \circlearrowleft \\ \downarrow \end{array} + \frac{1}{2} \begin{array}{c} \downarrow \\ \circlearrowright \\ \downarrow \end{array} + \begin{array}{c} \downarrow \\ \text{---} \\ \downarrow \end{array} \right) \\ &= \exp \left(\begin{array}{c} \downarrow \\ \text{---} \\ \downarrow \end{array} \right) \exp \left(\frac{1}{2} \begin{array}{c} \downarrow \\ \circlearrowleft \\ \downarrow \end{array} \right) \exp \left(\frac{1}{2} \begin{array}{c} \downarrow \\ \circlearrowright \\ \downarrow \end{array} \right), \end{aligned}$$

where the second equality follows from Lemma 3.6, and the last equality follows since

$$\begin{array}{c} \downarrow \\ \circlearrowleft \\ \downarrow \end{array}, \begin{array}{c} \downarrow \\ \circlearrowright \\ \downarrow \end{array}, \begin{array}{c} \downarrow \\ \text{---} \\ \downarrow \end{array}$$

mutually commute. Since $H_{\varphi, \beta}$ is triangular, we have

$$\begin{aligned} \iota^{-1}(R_{21} * R * (\mathbf{r} \otimes \mathbf{r})) &= (\iota^{-1}(R))^2(\iota^{-1}(\mathbf{r}) \otimes \iota^{-1}(\mathbf{r})) \\ &= \exp \left(\begin{array}{c} \downarrow \\ \text{---} \\ \downarrow \end{array} \right) \left(\exp \left(\frac{1}{2} \begin{array}{c} \downarrow \\ \circlearrowleft \\ \downarrow \end{array} \right) \otimes \exp \left(\frac{1}{2} \begin{array}{c} \downarrow \\ \circlearrowright \\ \downarrow \end{array} \right) \right). \end{aligned}$$

Hence we have (6.12). □

The universal property of \mathbf{A} (Theorem 5.11) implies the following generalization of Theorem 6.2. Let \mathcal{C} be a linear symmetric strict monoidal category equipped with a filtration $\mathcal{C} = \mathcal{F}^0 \supset \mathcal{F}^1 \supset \mathcal{F}^2 \supset \dots$. Let $\widehat{\mathcal{C}}^{\mathcal{F}} = \varprojlim_k \mathcal{C}/\mathcal{F}^k$ be the completion of \mathcal{C} with respect to \mathcal{F} , and let

$$j: \mathcal{C} \longrightarrow \widehat{\mathcal{C}}^{\mathcal{F}}$$

be the canonical functor. (See Section 10.1 for a brief review of filtrations and completions.)

Corollary 6.3. *Let (H, c) be a Casimir Hopf algebra in \mathcal{C} and assume that $c \in \mathcal{F}^1(H^{\otimes 0}, H^{\otimes 2})$. Then there is a unique continuous linear symmetric monoidal functor*

$$F_{(H,c)}: \widehat{\mathbf{A}} \longrightarrow \widehat{\mathcal{C}}^{\mathcal{F}}$$

that maps the Casimir Hopf algebra in $\widehat{\mathbf{A}}$ to $j(H, c)$. Therefore, $F_{(H,c)}$ maps the ribbon quasi-Hopf algebra in $\widehat{\mathbf{A}}$ to a ribbon quasi-Hopf algebra in $\widehat{\mathcal{C}}^{\mathcal{F}}$.

Remark 6.4. We can consider the quasi-triangular quasi-Hopf algebra

$$H_\varphi = (1, \mu, \eta, \Delta, \epsilon, \varphi, S, \nu, \eta, R)$$

as a deformation of the cocommutative Hopf algebra $H_0 := (1, \mu, \eta, \Delta, \epsilon, S)$ in the following way. Let $s \in \mathbb{K}$. An s -associator is a group-like element $\varphi(X, Y) \in \mathbb{K}\langle\langle X, Y \rangle\rangle$ satisfying the pentagon relation (6.14) and the following two hexagon relations:

$$\exp\left(\frac{s(t_{13} + t_{23})}{2}\right) = \varphi(t_{13}, t_{12}) \exp\left(\frac{st_{13}}{2}\right) \varphi(t_{13}, t_{23})^{-1} \exp\left(\frac{st_{23}}{2}\right) \varphi(t_{12}, t_{23}), \quad (6.22)$$

$$\exp\left(\frac{s(t_{12} + t_{13})}{2}\right) = \varphi(t_{23}, t_{13})^{-1} \exp\left(\frac{st_{13}}{2}\right) \varphi(t_{12}, t_{13}) \exp\left(\frac{st_{12}}{2}\right) \varphi(t_{12}, t_{23})^{-1}. \quad (6.23)$$

Note that a 1-associator is a Drinfeld associator in the sense of Section 6.2, and that 0-associators constitute the so-called *Grothendieck–Teichmüller group*. (In fact, Furusho [15] proved that if $\varphi(X, Y)$ satisfies (6.14), then it satisfies (6.22) and (6.23) for some s in the algebraic closure of \mathbb{K} .) Given an s -associator $\varphi_s(X, Y)$, define $\varphi_s: 0 \rightarrow 3$ and $\nu_s: 0 \rightarrow 1$ by (6.17) and (6.20), respectively, and define $R_s: 0 \rightarrow 2$ by (6.18) with c replaced with sc . Then, by a proof completely parallel to that of Theorem 6.2, it follows that

$$H_s := (1, \mu, \eta, \Delta, \epsilon, \varphi_s, S, \nu_s, \eta, R_s)$$

is a quasi-triangular quasi-Hopf algebra in $\widehat{\mathbf{A}}$. Assume now that φ is a Drinfeld associator. Then $\varphi_s(X, Y) := \varphi(sX, sY)$ is an s -associator for every $s \in \mathbb{K}$, so that $\{H_s\}_{s \in \mathbb{K}}$ is a one-parameter family of quasi-triangular quasi-Hopf algebras. We have $H_1 = H_\varphi$ and H_0 is a cocommutative Hopf algebra.

7. Weight systems

We illustrate the results of the previous two sections by considering weight systems, which transform Jacobi diagrams into linear maps.

7.1. Casimir Lie algebras and weight systems. A *Casimir Lie algebra* is a Lie algebra \mathfrak{g} (over \mathbb{K}) equipped with an ad-invariant, symmetric 2-tensor $c \in \mathfrak{g} \otimes \mathfrak{g}$. Then the universal enveloping algebra $U(\mathfrak{g})$ of \mathfrak{g} together with $c \in \mathfrak{g}^{\otimes 2} \subset U(\mathfrak{g})^{\otimes 2}$ is a Casimir Hopf algebra in the category of vector spaces.

Consequently, $(U(\mathfrak{g}), c)$ is also a Casimir Hopf algebra in $\mathbf{M}_{\mathfrak{g}} := \mathbf{Mod}_{U(\mathfrak{g})}$, the linear symmetric strict monoidal category of $U(\mathfrak{g})$ -modules. The universal property of \mathbf{A} gives a unique linear symmetric monoidal functor

$$W_{(\mathfrak{g}, c)}: \mathbf{A} \longrightarrow \mathbf{M}_{\mathfrak{g}}$$

mapping the Casimir Hopf algebra (H, c) in \mathbf{A} to the Casimir Hopf algebra $(U(\mathfrak{g}), c)$. We call $W_{(\mathfrak{g}, c)}$ the *weight system* of the Casimir Lie algebra (\mathfrak{g}, c) .

Example 7.1. (1) A *quadratic Lie algebra* is a pair (\mathfrak{g}, κ) of a finite-dimensional Lie algebra \mathfrak{g} and a non-degenerate symmetric ad-invariant bilinear form $\kappa: \mathfrak{g} \times \mathfrak{g} \rightarrow \mathbb{K}$. Let $c_\kappa \in \mathfrak{g} \otimes \mathfrak{g}$ be the 2-tensor corresponding to κ via

$$\mathrm{Hom}(\mathfrak{g} \otimes \mathfrak{g}, \mathbb{K}) \cong \mathrm{Hom}(\mathfrak{g}, \mathbb{K}) \otimes \mathrm{Hom}(\mathfrak{g}, \mathbb{K}) \cong \mathfrak{g} \otimes \mathfrak{g},$$

with the second isomorphism induced by κ . Then (\mathfrak{g}, c_κ) is a Casimir Lie algebra, and hence $(U(\mathfrak{g}), c_\kappa)$ is a Casimir Hopf algebra in the category of vector spaces.

(2) The *Cartan trivector* $T_\kappa \in \mathfrak{g}^{\otimes 3}$ of (\mathfrak{g}, κ) is the skew-symmetric, ad-invariant 3-tensor corresponding to the trilinear form

$$\mathfrak{g} \otimes \mathfrak{g} \otimes \mathfrak{g} \longrightarrow \mathbb{K}, \quad (x, y, z) \longmapsto \kappa([x, y], z).$$

We have

$$T_\kappa = W_{(\mathfrak{g}, c_\kappa)} \left(\left(\begin{array}{c} \text{---} \\ \diagup \quad \diagdown \\ \text{---} \\ \diagdown \quad \diagup \\ \text{---} \\ \text{---} \end{array} \right) \right) \in U(\mathfrak{g})^{\otimes 3}.$$

7.2. Continuous weight systems. Let $\mathbb{K}[[h]]$ be the formal power series algebra. For a vector space V , let $V[[h]]$ denote the h -adic completion of $V \otimes \mathbb{K}[[h]]$.

We fix a Casimir Lie algebra (\mathfrak{g}, c) . Let $\mathbf{M}_{\mathfrak{g}}[[h]]$ be the $\mathbb{K}[[h]]$ -linear symmetric strict monoidal category such that $\text{Ob}(\mathbf{M}_{\mathfrak{g}}[[h]]) = \text{Ob}(\mathbf{M}_{\mathfrak{g}})$ and

$$\mathbf{M}_{\mathfrak{g}}[[h]](V, W) = \mathbf{M}_{\mathfrak{g}}(V, W)[[h]]$$

for $V, W \in \text{Ob}(\mathbf{M}_{\mathfrak{g}}[[h]])$. The composition in the category $\mathbf{M}_{\mathfrak{g}}[[h]]$ and its symmetric strict monoidal structure are inherited from $\mathbf{M}_{\mathfrak{g}}$ in the obvious way.

Since $(U(\mathfrak{g}), c)$ is a Casimir Hopf algebra in $\mathbf{M}_{\mathfrak{g}}$, so is $(U(\mathfrak{g}), hc)$ in $\mathbf{M}_{\mathfrak{g}}[[h]]$. By the universal property of \mathbf{A} , there is a unique linear symmetric monoidal functor

$$W_{(\mathfrak{g}, hc)}: \mathbf{A} \longrightarrow \mathbf{M}_{\mathfrak{g}}[[h]]$$

such that $W_{(\mathfrak{g}, hc)}(m) = U(\mathfrak{g})^{\otimes m}$ for $m \geq 0$ and which maps the Casimir Hopf algebra (H, c) in \mathbf{A} to the Casimir Hopf algebra $(U(\mathfrak{g}), hc)$ in $\mathbf{M}_{\mathfrak{g}}[[h]]$. By continuity, the functor $W_{(\mathfrak{g}, hc)}$ above extends uniquely as

$$\widehat{W}_{(\mathfrak{g}, hc)}: \widehat{\mathbf{A}} \longrightarrow \mathbf{M}_{\mathfrak{g}}[[h]].$$

Remark 7.2. (1) Let \mathfrak{g} be a Lie algebra. One could also work within $\mathbf{Mod}_{U(\mathfrak{g})[[h]]}$, the category of $U(\mathfrak{g})[[h]]$ -modules, instead of $\mathbf{M}_{\mathfrak{g}}[[h]]$. In fact, there is a canonical linear functor

$$i: \mathbf{M}_{\mathfrak{g}}[[h]] \longrightarrow \mathbf{Mod}_{U(\mathfrak{g})[[h]]}$$

which maps each $U(\mathfrak{g})$ -module V to $V[[h]]$ and maps each $f: V \rightarrow W$ in $\mathbf{M}_{\mathfrak{g}}[[h]]$, i.e., $f \in \mathbf{M}_{\mathfrak{g}}(V, W)[[h]]$, to the map $i(f): V[[h]] \rightarrow W[[h]]$ induced by f . Since the functor i is fully faithful, we may regard $\mathbf{M}_{\mathfrak{g}}[[h]]$ as a subcategory of $\mathbf{Mod}_{U(\mathfrak{g})[[h]]}$.

(2) Let (\mathfrak{g}, c) be a Casimir Lie algebra. Then, by Corollary 6.3, the composition

$$i \circ \widehat{W}_{(\mathfrak{g}, hc)}: \widehat{\mathbf{A}} \longrightarrow \mathbf{Mod}_{U(\mathfrak{g})[[h]]}$$

maps the ribbon quasi-Hopf algebra in $\widehat{\mathbf{A}}$ (see Theorem 6.2) to a ribbon quasi-Hopf algebra structure on $U(\mathfrak{g})[[h]]$. This structure is known from Drinfeld's work [14]. See [30, Theorem XIX.4.2] for the description of the underlying quasi-triangular quasi-bialgebra structure.

8. Construction of the functor Z

In this section, we construct a functor

$$Z: \mathcal{B}_q \longrightarrow \widehat{\mathbf{A}}, \tag{8.1}$$

from the non-strictification \mathcal{B}_q of \mathcal{B} to the degree-completion $\widehat{\mathbf{A}}$ of \mathbf{A} .

8.1. The category \mathcal{B}_q of bottom q -tangles in handlebodies. Define the category \mathcal{B}_q of bottom q -tangles in handlebodies to be the non-strictification (see Section 3.3) of the strict monoidal category \mathcal{B} . Here we identify $\text{Ob}(\mathcal{B}) = \mathbb{N}$ with the free monoid $\text{Mon}(\bullet)$ on an element \bullet . Hence we have $\text{Ob}(\mathcal{B}_q) = \text{Mag}(\bullet)$, the free unital magma on \bullet .

Example 8.1. For $w \in \text{Mag}(\bullet)$, we regard $\mathcal{B}_q(\emptyset, w)$ as a subset of $\mathcal{T}_q(\emptyset, w(+\!-\!))$, where $w(+\!-\!) \in \text{Mag}(\pm)$ is obtained from w by substituting $\bullet = (+\!-\!)$.

8.2. The extended Kontsevich integral Z . The rest of this section is devoted to the proof of following result.

Theorem 8.2. *There is a functor $Z: \mathcal{B}_q \rightarrow \widehat{\mathbf{A}}$ such that*

- (i) *for $w \in \text{Mag}(\bullet)$, we have $Z(w) = |w|$,*
- (ii) *if $T \in \mathcal{B}_q(\emptyset, w) \subset \mathcal{T}_q(\emptyset, w(+\!-\!))$, $w \in \text{Mag}(\bullet)$, then the value of Z on T is the usual Kontsevich integral $Z(T)$, as defined in Section 3.7,*
- (iii) *Z is tensor-preserving, i.e., we have*

$$Z(T \otimes T') = Z(T) \otimes Z(T')$$

for morphisms T and T' in \mathcal{B}_q .

The functor $Z: \mathcal{B}_q \rightarrow \widehat{\mathbf{A}}$ is *not* a monoidal functor. By replacing the target monoidal category $\widehat{\mathbf{A}}$ with an appropriate “parenthesized” version $\widehat{\mathbf{A}}_q^\varphi$, we can make Z into a braided monoidal functor $Z_q^\varphi: \mathcal{B}_q \rightarrow \widehat{\mathbf{A}}_q^\varphi$; see Section 9.3.

8.3. Notations. Let \mathcal{C} be a monoidal category with (left) duals. The dual of $x \in \text{Ob}(\mathcal{C})$ is denoted by x^* . For $x \in \text{Ob}(\mathcal{C})$, set

$$d(x) = x \otimes x^* \in \text{Ob}(\mathcal{C}).$$

We extend this definition to finite sequences of objects of \mathcal{C} as follows.

First, assume that the monoidal category \mathcal{C} is strict. For $\underline{x} = (x_1, \dots, x_k) \in \text{Ob}(\mathcal{C})^k$ ($k \geq 1$), set

$$d(\underline{x}) = d(x_1, \dots, x_k) := d(x_1) \otimes \cdots \otimes d(x_k) \in \text{Ob}(\mathcal{C}).$$

Now, assume that the monoidal category \mathcal{C} is non-strict. For $w \in \text{Mag}(\bullet)$ of length $k \geq 1$ and $\underline{y} = (y_1, \dots, y_k) \in \text{Ob}(\mathcal{C})^k$, let $w(\underline{y}) = w(y_1, \dots, y_k) \in \text{Ob}(\mathcal{C})$ be the object obtained from w by replacing its k consecutive letters by y_1, \dots, y_k

in this order. (For instance, if $k = 3$ and $w = ((\bullet\bullet)\bullet)$, then $w(y_1, y_2, y_3) = (y_1 \otimes y_2) \otimes y_3$.) Set

$$d^w(\underline{x}) = d^w(x_1, \dots, x_k) := w(d(x_1), \dots, d(x_k))$$

for $\underline{x} = (x_1, \dots, x_k) \in \text{Ob}(\mathcal{C})^k$.

Moreover, we will need the following notation when the monoidal category \mathcal{C} is non-strict. Let $w \in \text{Mag}(\bullet)$ of length k , let $\underline{x} = (x_1, \dots, x_k)$, $\underline{y} = (y_1, \dots, y_k) \in \text{Ob}(\mathcal{C})^k$ and let $f_1: x_1 \rightarrow y_1, \dots, f_k: x_k \rightarrow y_k$ be morphisms in \mathcal{C} . Then,

$$w(f_1, \dots, f_k): w(\underline{x}) \longrightarrow w(\underline{y})$$

denotes the “ w -parenthesized” tensor product of f_1, \dots, f_k .

8.4. Construction of Z . Let $m, n \geq 0$. We decompose the handlebody V_m as

$$V_m = \underbrace{([-1, 1]^2 \times [0, 7/8])}_{\text{a “lower” copy of the cube}} \cup \underbrace{([-1, 1]^2 \times [7/8, 1] \cup (m \text{ 1-handles}))}_{\text{an “upper” copy of } V_m}. \quad (8.2)$$

For every $T: m \rightarrow n$ in \mathcal{B} there is an n -component bottom tangle in V_m such that

- it intersects transversally the square $[-1, 1]^2 \times \{7/8\}$ in finitely many points uniformly distributed along the line $[-1, 1] \times \{0\} \times \{7/8\}$,
- its intersection with the “upper” part of (8.2) consists of finitely many parallel copies of the cores of the 1-handles.

Then T is determined by the intersection of this representative tangle with the “lower” part of (8.2), which defines a tangle

$$U: d(v_1, \dots, v_m) \longrightarrow (+-)^n \quad \text{in } \mathcal{T}$$

for some $v_1, \dots, v_m \in \text{Mon}(\pm)$. We call U a *cube presentation* of T .

Example 8.3. Here is a 3-component bottom tangle T in V_2 , together with a cube presentation U where $v_1 = v_2 = (++)$:

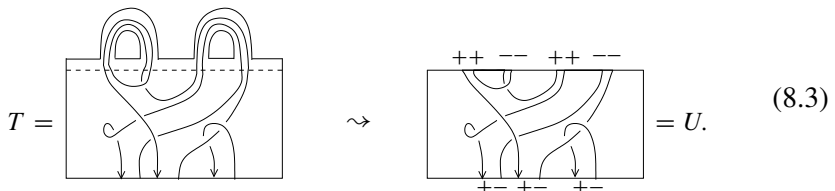

$$T = \text{[Diagram of } T \text{]} \rightsquigarrow \text{[Diagram of } U \text{]} = U. \quad (8.3)$$

If T is upgraded to a morphism $T: v \rightarrow w$ in \mathcal{B}_q with $|v| = m$, $|w| = n$, and if v_1, \dots, v_m are upgraded to $v_1, \dots, v_m \in \text{Mag}(\pm)$, then we call

$$U: d^v(v_1, \dots, v_m) \longrightarrow w(+ -) \quad \text{in } \mathcal{T}_q$$

a *cube presentation* of the bottom q -tangle T .

Definition 8.4. Let $T: v \rightarrow w$ in \mathcal{B}_q with $m = |v|$, $n = |w|$, and let

$$U: d^v(v_1, \dots, v_m) \longrightarrow w(+ -) \quad \text{in } \mathcal{T}_q$$

be a cube presentation of T . The *extended Kontsevich integral* of T is the morphism

$$Z(T): m \longrightarrow n \quad \text{in } \widehat{\mathcal{A}}$$

with square presentation

$$Z(U) \circ (a_{v_1} \otimes \text{id}_{v_1^*} \otimes \cdots \otimes a_{v_m} \otimes \text{id}_{v_m^*}): d(v_1, \dots, v_m) \longrightarrow (+ -)^n \quad \text{in } \mathcal{A}.$$

Thus, diagrammatically, we have

(8.4)

The next lemma shows that the extended Kontsevich integral is well defined.

Lemma 8.5. Let $T: v \rightarrow w$ in \mathcal{B}_q , $m = |v|$, $n = |w|$. For all cube presentations

$$U: d^v(v_1, \dots, v_m) \longrightarrow w(+ -), \quad U': d^v(v'_1, \dots, v'_m) \longrightarrow w(+ -) \quad \text{in } \mathcal{T}_q$$

of T , the morphisms

$$\begin{aligned} & Z(U) \circ (a_{v_1} \otimes \text{id}_{v_1^*} \otimes \cdots \otimes a_{v_m} \otimes \text{id}_{v_m^*}), \\ & Z(U') \circ (a_{v'_1} \otimes \text{id}_{(v'_1)^*} \otimes \cdots \otimes a_{v'_m} \otimes \text{id}_{(v'_m)^*}) \end{aligned}$$

are square presentations of the same morphism $m \rightarrow n$ in $\widehat{\mathcal{A}}$.

Proof. For $V: x \rightarrow y$ in \mathcal{T}_q , let $r(V): y^* \rightarrow x^*$ denote the π -rotation of V around the \vec{y} axis of \mathbb{R}^3 .

We can realize an isotopy of bottom tangles with cube presentations as a sequence of isotopies of cube presentations and “sliding subtangles through the handles”. (Similar arguments appear in [42].) Thus, without loss of generality, we can assume that there are morphisms $T_0: v(v_1(v'_1)^*, \dots, v_m(v'_m)^*) \rightarrow w(+ -)$ and $T_1: v'_1 \rightarrow v_1, \dots, T_m: v'_m \rightarrow v_m$ in \mathcal{T}_q such that

$$\begin{cases} U = T_0 \circ v(\text{id}_{v_1} \otimes r(T_1), \dots, \text{id}_{v_m} \otimes r(T_m)), \\ U' = T_0 \circ v(T_1 \otimes \text{id}_{(v'_1)^*}, \dots, T_m \otimes \text{id}_{(v'_m)^*}). \end{cases}$$

It follows that

$$\begin{cases} Z(U) \circ A = Z(T_0) \circ (a_{v_1} \otimes Z(r(T_1)) \otimes \dots \otimes a_{v_m} \otimes Z(r(T_m))), \\ Z(U') \circ A' = Z(T_0) \circ (Z(T_1)a_{v'_1} \otimes \text{id}_{(v'_1)^*} \otimes \dots \otimes Z(T_m)a_{v'_m} \otimes \text{id}_{(v'_m)^*}), \end{cases}$$

where $A := (a_{v_1} \otimes \text{id}_{v_1^*} \otimes \dots \otimes a_{v_m} \otimes \text{id}_{v_m^*})$, and A' is defined similarly from the words v'_1, \dots, v'_m . Thus, it suffices to prove that

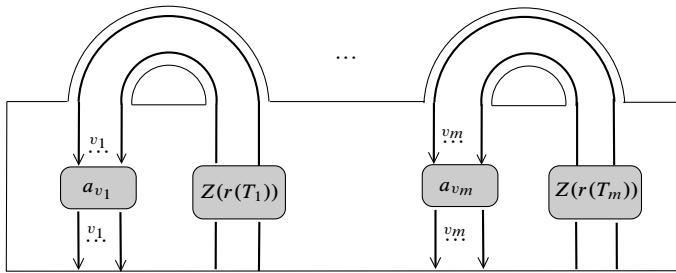

is equal to

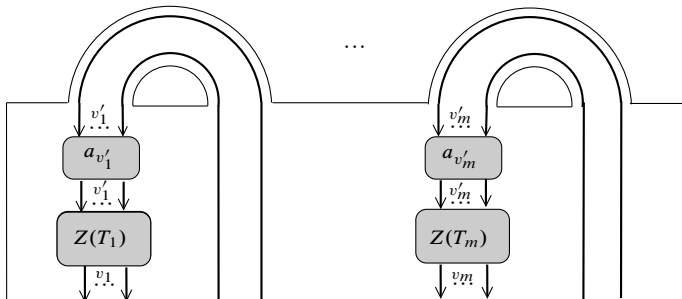

in the space of $F(x_1, \dots, x_m)$ -colored Jacobi diagrams on the appropriate oriented 1-manifold. For this, it suffices to show that

$$\begin{array}{c} \downarrow v'_i \\ \dots \\ \downarrow \\ rZr(T_i) \\ \downarrow v'_i \\ \dots \\ \downarrow \\ a_{v_i} \\ \downarrow v_i \\ \dots \\ \downarrow \end{array} = \begin{array}{c} \downarrow v'_i \\ \dots \\ \downarrow \\ a_{v'_i} \\ \downarrow v'_i \\ \dots \\ \downarrow \\ Z(T_i) \\ \downarrow v_i \\ \dots \\ \downarrow \end{array} : v'_i \longrightarrow v_i \text{ in } \mathcal{A},$$

which follows by applying the usual Kontsevich integral to the following identity of q -tangles:

$$\begin{array}{c} \text{---} \\ \uparrow \text{---} \\ \uparrow \text{---} \\ \downarrow \dots \\ \downarrow \dots \\ \downarrow \dots \\ r(T_i) \\ \downarrow \dots \\ \downarrow \dots \\ \downarrow \dots \end{array} = \begin{array}{c} \text{---} \\ \uparrow \text{---} \\ \uparrow \text{---} \\ \downarrow \dots \\ \downarrow \dots \\ \downarrow \dots \\ T_i \\ \downarrow \dots \\ \downarrow \dots \\ \downarrow \dots \end{array} : \emptyset \longrightarrow v_i(v'_i)^* \text{ in } \mathcal{T}_q. \quad \square$$

Obviously, we have (ii) in Theorem 8.2. We have (iii) since the usual Kontsevich integral itself is tensor-preserving. Therefore, it remains to prove that Z is functorial.

8.5. Functoriality of Z . To prove that Z is a functor, we need a recurrence formula on the cabling anomalies $a_w: w \rightarrow w$ in \mathcal{A} .

Lemma 8.6. *For each $w \in \text{Mag}(\pm)$ of length n and each map*

$$f: \pi_0(\downarrow \dots \downarrow)^w = \{1, \dots, n\} \longrightarrow \text{Mag}(\pm),$$

we have

$$a_{C_f(w)} = (r^{[w_1]}(a_{f(1)}) \otimes \dots \otimes r^{[w_n]}(a_{f(n)})) \circ C_f(a_w) \in \mathcal{A}(\downarrow \dots \downarrow)^{C_f(w)},$$

where $r^{[+]} = \text{id}$ and $r^{[-]} = r$ with r being the π -rotation.

Proof. Setting $x = C_f(w) \in \text{Mag}(\pm)$, we have

$$\begin{array}{c} \text{---} \\ \uparrow \text{---} \\ \uparrow \text{---} \\ \downarrow \dots \\ \downarrow \dots \\ \downarrow \dots \\ a_x \\ \downarrow \dots \\ \downarrow \dots \\ \downarrow \dots \end{array} = ZC_x \left(\begin{array}{c} \text{---} \\ \uparrow \text{---} \\ \uparrow \text{---} \\ \downarrow \dots \\ \downarrow \dots \\ \downarrow \dots \\ (+-) \end{array} \right) = ZC_f C_w \left(\begin{array}{c} \text{---} \\ \uparrow \text{---} \\ \uparrow \text{---} \\ \downarrow \dots \\ \downarrow \dots \\ \downarrow \dots \\ (+-) \end{array} \right).$$

By Lemma 3.9, we deduce that

$$\begin{aligned}
 & \text{Diagram with box } a_x \text{ and strands } x, x^* \text{ and a crossing} \\
 &= c(w w^*, f_t) \circ C_f Z C_w \left(\text{Diagram with crossing } (+-) \right) \\
 &= c(w w^*, f_t) \circ C_f \left(\text{Diagram with box } a_w \text{ and strands } w, w^* \text{ and a crossing} \right) \\
 &= c(w w^*, f_t) \circ \text{Diagram with box } C_f(a_w) \text{ and strands } x, x^* \text{ and a crossing}.
 \end{aligned}$$

The series of diagrams $c(w w^*, f_t)$ is obtained from $\text{id}_w \otimes \text{id}_{w^*}$ by replacing the i -th string of id_w by $a_{f(i)}$ if $w_i = +$ or by $\text{id}_{f(i)^*}$ if $w_i = -$ and, next, by replacing the i -th string of id_{w^*} by $a_{f(n-i+1)}$ if $w_{n-i+1} = -$ or by $\text{id}_{f(n-i+1)^*}$ if $w_{n-i+1} = +$. Thus, using the STU relation, we obtain

$$\text{Diagram with box } a_x \text{ and strands } x, x^* \text{ and a crossing} = (r^{[w_1]}(a_{f(1)}) \otimes \cdots \otimes r^{[w_n]}(a_{f(n)}) \otimes \text{id}_{x^*}) \circ \text{Diagram with box } C_f(a_w) \text{ and strands } x, x^* \text{ and a crossing}$$

and we have the conclusion. \square

Let $v \xrightarrow{T} w \xrightarrow{T'} x$ in \mathcal{B}_q with $|v| = m$, $|w| = n$, $|x| = p$, and let

$$U: \mathbf{d}^v(v_1, \dots, v_m) \longrightarrow w(+), \quad U': \mathbf{d}^w(w_1, \dots, w_n) \longrightarrow x(+-) \quad \text{in } \mathcal{T}_q$$

be cube presentations of T and T' , respectively. Then

$$U' \circ C_f(U): \mathbf{d}^v(v'_1, \dots, v'_m) \longrightarrow x(+-) \quad \text{in } \mathcal{T}_q$$

is a cube presentation of $T' \circ T: v \rightarrow x$, where $f: \pi_0(U) \rightarrow \text{Mag}(\pm)$ is an appropriate map and $v'_1, \dots, v'_m \in \text{Mag}(\pm)$ are such that

$$C_{f_s}(\mathbf{d}^v(v_1, \dots, v_m)) = \mathbf{d}^v(v'_1, \dots, v'_m).$$

Therefore, $Z(T' \circ T)$ has the following square presentation:

$$\begin{aligned}
& Z(U' \circ C_f(U)) \circ (a_{v'_1} \otimes \text{id}_{(v'_1)^*} \otimes \cdots \otimes a_{v'_m} \otimes \text{id}_{(v'_m)^*}) \\
&= Z(U') \circ Z(C_f(U)) \circ (a_{v'_1} \otimes \text{id}_{(v'_1)^*} \otimes \cdots \otimes a_{v'_m} \otimes \text{id}_{(v'_m)^*}) \\
&= Z(U') \circ c(w(+), f_t) \circ C_f Z(U) \\
&\quad \circ c(\mathbf{d}^v(v_1, \dots, v_m), f_s)^{-1} \circ (a_{v'_1} \otimes \text{id}_{(v'_1)^*} \otimes \cdots \otimes a_{v'_m} \otimes \text{id}_{(v'_m)^*}) \\
&= Z(U') \circ (a_{w_1} \otimes \text{id}_{w_1^*} \otimes \cdots \otimes a_{w_n} \otimes \text{id}_{w_n^*}) \circ C_f Z(U) \\
&\quad \circ c(\mathbf{d}^v(v_1, \dots, v_m), f_s)^{-1} \circ (a_{v'_1} \otimes \text{id}_{(v'_1)^*} \otimes \cdots \otimes a_{v'_m} \otimes \text{id}_{(v'_m)^*}).
\end{aligned}$$

Here the second identity is given by Lemma 3.9. By m applications of Lemma 8.6 and using the STU relation, we obtain the following square presentation of $Z(T' \circ T)$:

$$\begin{aligned}
& Z(U') \circ (a_{w_1} \otimes \text{id}_{w_1^*} \otimes \cdots \otimes a_{w_n} \otimes \text{id}_{w_n^*}) \circ C_f Z(U) \\
&\quad \circ C_{f_s}(a_{v_1} \otimes \text{id}_{v_1^*} \otimes \cdots \otimes a_{v_m} \otimes \text{id}_{v_m^*}) \\
&= Z(U') \circ (a_{w_1} \otimes \text{id}_{w_1^*} \otimes \cdots \otimes a_{w_n} \otimes \text{id}_{w_n^*}) \\
&\quad \circ C_f(Z(U) \circ (a_{v_1} \otimes \text{id}_{v_1^*} \otimes \cdots \otimes a_{v_m} \otimes \text{id}_{v_m^*})).
\end{aligned}$$

By Lemma 4.10, we have $Z(T' \circ T) = Z(T') \circ Z(T)$.

8.6. Proof of Theorem 1.2. Consider a morphism $T: v \rightarrow w$ in \mathcal{B}_q with a decomposition into q -tangles T_0, T_1, \dots, T_m as shown in (1.7), where $m := |v|$, $n := |w|$ and

$$T_0: v(u_1 u'_1, \dots, u_m u'_m) \longrightarrow w(+), \quad T_i: \emptyset \longrightarrow u_i u'_i \quad (i = 1, \dots, m) \quad \text{in } \mathcal{T}_q.$$

To deduce Theorem 1.2 from Theorem 8.2, it suffices to show that the functor $Z: \mathcal{B}_q \rightarrow \hat{\mathbf{A}}$ resulting from the latter satisfies (1.8) with $Z^{\mathcal{B}} := Z$. Let us write

$$T = [T_0; T_1, \dots, T_m] = [T_0; (T_i)_{i=1, \dots, m}]$$

and extend this notation $[-; -, \dots, -]$ to other compatible sequences of q -tangles T'_0, T'_1, \dots, T'_m . We use the same kind of notation for Jacobi diagrams. In these notations, what we have to prove is the following:

$$Z(T) = [Z(T_0); Z(T_1), \dots, Z(T_m)]. \quad (8.5)$$

For each $i = 1, \dots, m$, let $\tilde{T}_i: u_i^* \rightarrow u'_i$ be the unique morphism in \mathcal{T}_q such that

$$T_i = (\text{id}_{u_i} \otimes \tilde{T}_i) \circ C_{u_i} \left(\begin{array}{c} \curvearrowright \\ \downarrow \end{array} \right). \quad (8.6)$$

Then, we have

$$\begin{aligned}
& [Z(T_0); Z(T_1), \dots, Z(T_m)] \\
& \stackrel{(8.6)}{=} [Z(T_0); (Z((\text{id}_{u_i} \otimes \tilde{T}_i) \circ C_{u_i}(\downarrow \curvearrowright)))_{i=1, \dots, m}] \\
& = [Z(T_0); (Z(\text{id}_{u_i} \otimes \tilde{T}_i) \circ Z(C_{u_i}(\downarrow \curvearrowright)))_{i=1, \dots, m}] \\
& = \left[Z(T_0) \circ \bigotimes_{i=1}^m Z(\text{id}_{u_i} \otimes \tilde{T}_i); (Z(C_{u_i}(\downarrow \curvearrowright)))_{i=1, \dots, m} \right] \\
& = \left[Z\left(T_0 \circ \bigotimes_{i=1}^m (\text{id}_{u_i} \otimes \tilde{T}_i)\right); (Z(C_{u_i}(\downarrow \curvearrowright)))_{i=1, \dots, m} \right].
\end{aligned}$$

By Definition 8.4 and (3.8), the right hand side is equal to

$$\begin{aligned}
& Z\left(\left[T_0 \circ \bigotimes_{i=1}^m (\text{id}_{u_i} \otimes \tilde{T}_i); (C_{u_i}(\downarrow \curvearrowright))_{i=1, \dots, m}\right]\right) \\
& = Z\left([T_0; ((\text{id}_{u_i} \otimes \tilde{T}_i) \circ C_{u_i}(\downarrow \curvearrowright))_{i=1, \dots, m}]\right) \\
& \stackrel{(8.6)}{=} Z([T_0; (T_i)_{i=1, \dots, m}]) = Z(T).
\end{aligned}$$

Hence we have (8.5), which completes the proof of Theorem 1.2.

8.7. Group-like property of Z . Recall from Section 4.5 that the category $\hat{\mathbf{A}}$ is enriched over cocommutative coalgebras, and that there is a monoidal subcategory $\hat{\mathbf{A}}^{\text{grp}}$ of $\hat{\mathbf{A}}$, the group-like part of $\hat{\mathbf{A}}$.

Proposition 8.7. *The extended Kontsevich integral Z takes group-like values, i.e., for $T: v \rightarrow w$ in \mathcal{B}_q , we have*

$$Z(T) \in \hat{\mathbf{A}}^{\text{grp}}(|v|, |w|).$$

Thus we have a (tensor-preserving) functor $Z: \mathcal{B}_q \rightarrow \hat{\mathbf{A}}^{\text{grp}}$.

Proof. Since the usual Kontsevich integral takes group-like values, this follows from Lemma 4.16 and the definition of $Z(T)$ using a cube presentation of T . \square

8.8. F-grading on Z . We recall from Section 4.4 that the linear category \mathbf{A} is graded over the opposite of the category \mathbf{F} of finitely generated free groups, and that this grading corresponds to homotopy classes of Jacobi diagrams in handlebodies. Similarly, we define the *homotopy class* of $T: m \rightarrow n$ in \mathcal{B} to be the group homomorphism $h(T): F_n \rightarrow F_m$ induced by $i_T: V_n \rightarrow V_m$ on fundamental groups.

Proposition 8.8. *The extended Kontsevich integral Z preserves the homotopy class: if $T: v \rightarrow w$ in \mathcal{B}_q , then we have*

$$Z(T) \in \widehat{\mathbf{A}}(|v|, |w|)_{h(T)}.$$

Proof. This follows from the definition of $Z(T)$ using a cube presentation of T . \square

9. The braided monoidal functor Z_q^φ and computation of Z

In this section, we assume that the associator $\Phi \in \mathcal{A}(\downarrow\downarrow\downarrow)$ used in the construction of $Z: \mathcal{B}_q \rightarrow \widehat{\mathbf{A}}$ arises from a Drinfeld associator $\varphi(X, Y) \in \mathbb{K}\langle\langle X, Y \rangle\rangle$ as explained in Remark 6.1. We compute Z on a generating set of \mathcal{B}_q and construct a braided monoidal functor $Z_q^\varphi: \mathcal{B}_q \rightarrow \widehat{\mathbf{A}}_q^\varphi$, which is a variant of Z with values in a deformation of the non-strictification of $\widehat{\mathbf{A}}$.

9.1. Generators of \mathcal{B}_q . As announced in [22, §14.5] and will be proved in [25], the strict monoidal category \mathcal{B} is generated by the morphisms

$$\begin{aligned}
 \psi &:= \text{[diagram: crossing of two strands]}, & \psi^{-1} &:= \text{[diagram: inverse crossing of two strands]}, \\
 \mu &:= \text{[diagram: multiplication]}, & \Delta &:= \text{[diagram: comultiplication]}, & \eta &:= \text{[diagram: unit]}, & \epsilon &:= \text{[diagram: counit]}, \\
 S &:= \text{[diagram: antipode]}, & S^{-1} &:= \text{[diagram: inverse antipode]}, & r_+ &:= \text{[diagram: ribbon element]}, & r_- &:= \text{[diagram: inverse ribbon element]}.
 \end{aligned} \tag{9.1}$$

The monoidal category \mathcal{B} has a unique braiding

$$\psi_{p,q}: p + q \longrightarrow q + p, \quad p, q \geq 0$$

such that $\psi_{1,1} = \psi$. The object 1 is a Hopf algebra in the braided category \mathcal{B} , with multiplication μ , unit η , comultiplication Δ , counit ϵ and invertible antipode S . The canonical functor $\mathcal{B} \rightarrow \mathcal{Cob}$ (see Section 2.4) maps this Hopf algebra to the Hopf algebra in \mathcal{Cob} given by Crane and Yetter [11] and Kerler [34], and it maps the morphisms r_\pm to the “ribbon elements” in the sense of [35].

Example 9.1. We can use the Hopf algebra structure of 1 in \mathcal{B} to define some additional morphisms. The *adjoint action* is the morphism

$$\text{ad} := \mu^{[3]}(\text{id}_1 \otimes \psi)(\text{id}_1 \otimes S \otimes \text{id}_1)(\Delta \otimes \text{id}_1) = \begin{array}{|c|} \hline \text{Diagram} \\ \hline \end{array} : 2 \longrightarrow 1.$$

Using the ribbon elements r_{\pm} and following [35], we define

$$\mathbf{c} := (\mu(r_- \otimes \text{id}_1) \otimes \mu(\text{id}_1 \otimes r_-))\Delta r_+ = \begin{array}{|c|} \hline \text{Diagram} \\ \hline \end{array} : 0 \longrightarrow 2.$$

The above generating set for the strict monoidal category \mathcal{B} induces a generating set for the non-strict monoidal category \mathcal{B}_q :

$$\begin{aligned} \psi^{\pm 1}: \bullet\bullet &\longrightarrow \bullet\bullet, & \mu: \bullet\bullet &\longrightarrow \bullet, & \eta, r_{\pm}: \emptyset &\longrightarrow \bullet, \\ \Delta: \bullet &\longrightarrow \bullet\bullet, & \epsilon: \bullet &\longrightarrow \emptyset, & S^{\pm 1}: \bullet &\longrightarrow \bullet. \end{aligned}$$

The associativity isomorphisms of \mathcal{B}_q are denoted by $\alpha_{u,v,w}: (uv)w \rightarrow u(vw)$.

9.2. Values of Z on the generators. We compute the values of Z on the generators of the monoidal category \mathcal{B}_q given in the previous subsection. Our formulas will be expressed only in terms of the chosen Drinfeld associator $\varphi(X, Y)$, and they will involve the structural morphisms of the Casimir Hopf algebra $(H, c) = (1, \eta, \mu, \epsilon, \Delta, S, c)$ in \mathbf{A} . (See Proposition 5.10.)

As in Section 6.3, we equip $\widehat{\mathbf{A}}(0, m)$ ($m \geq 0$) with its convolution product $*$ and consider the following morphisms in $\widehat{\mathbf{A}}$:

$$\begin{aligned} \varphi &= \varphi(c_{12}, c_{23}): 0 \longrightarrow 3, \\ R &= \exp_*(c/2): \longrightarrow 2, \\ \mathbf{r} &= \exp_*(\mu c/2): 0 \longrightarrow 1. \end{aligned}$$

Set

$$v = (\mu^{[3]}(\text{id}_1 \otimes S \otimes \text{id}_1)\varphi)^{-1}: 0 \longrightarrow 1 \quad \text{in } \widehat{\mathbf{A}},$$

where $()^{-1}$ denotes convolution-inverse. Note that v corresponds to the element (6.20) of $\mathcal{A}(\downarrow)$ through the isomorphism ι of Section 6.3.

In what follows, we use the usual graphical calculus for morphisms in $\widehat{\mathbf{A}}$, where morphisms run downwards. The antipode S , the iterated multiplication $\mu^{[n]}$

and the iterated comultiplication $\Delta^{[n]}$ ($n \geq 0$) are depicted by

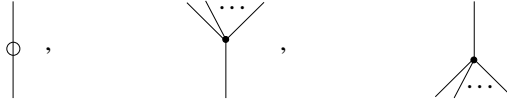

respectively. For instance, the adjoint action of the Hopf algebra H

$$\text{ad} = \mu^{[3]}(\text{id}_1 \otimes P_{1,1})(\text{id}_1 \otimes S \otimes \text{id}_1)(\Delta \otimes \text{id}_1): 2 \longrightarrow 1$$

is depicted by

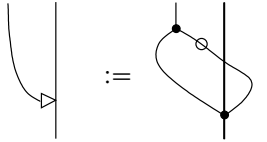

Proposition 9.2. *We have*

$$Z(\psi^{\pm 1}) = \text{diagram with } R^{\pm 1} \text{ label}, \quad Z(r_{\pm}) = \text{diagram with } r^{\mp 1} \text{ label}, \quad Z(\eta) = \text{diagram}, \quad Z(\epsilon) = \text{diagram}, \quad (9.2)$$

$$Z(\alpha_{u,v,w}^{\pm 1}) = \text{diagram with } \varphi^{\pm 1} \text{ label and } |u|, |v|, |w| \text{ labels}, \quad \text{for } u, v, w \in \text{Mag}(\bullet), \quad (9.3)$$

$$Z(S^{\pm 1}) = \text{diagram with } r^{\pm 1/2} \text{ label}, \quad (9.4)$$

$$Z(\mu) = \text{diagram with } \varphi, \varphi^{-1}, v \text{ labels}, \quad (9.5)$$

$$Z(\Delta) = \text{Diagram} \quad (9.6)$$

Proof. First, we briefly explain how to compute $Z(\psi)$, $Z(r_+)$, $Z(\eta)$, $Z(\epsilon)$ and $Z(\alpha_{u,v,w})$. One can compute $Z(\psi^{-1})$, $Z(r_-)$ and $Z(\alpha_{u,v,w}^{-1})$ similarly. We only indicate the decompositions into q -tangles of some cube presentations leading to (9.2) and (9.3):

$$\begin{aligned} \psi &= \text{Diagram} , r_+ = \text{Diagram} , \\ \eta &= \text{Diagram} , \epsilon = \text{Diagram} , \\ \alpha_{u,v,w} &= \text{Diagram} \end{aligned}$$

We leave the details to the interested reader.

Now we compute $Z(S)$. Since

$$S = \text{Diagram}$$

we have

$$\begin{aligned}
 Z(S) = & \left[\text{Diagram 1} \right] = \left[\text{Diagram 2} \right] \\
 & = \left[\text{Diagram 3} \right]
 \end{aligned}$$

Diagram 1: A rectangular box with a top semi-circular cap and a bottom crossing. A dashed horizontal line is labeled $\exp(-\frac{1}{2})$. A solid horizontal line above it is labeled $\exp(\frac{1}{2})$.

Diagram 2: Similar to Diagram 1, but the solid line is split into two segments, each labeled $\exp(\frac{1}{4})$.

Diagram 3: Similar to Diagram 2, but with two shaded horizontal bands and a dashed line connecting them, labeled $\exp(\frac{1}{4})$.

which implies (9.4). The computation of $Z(S^{-1})$ is similar.

One can easily derive (9.5) from the following decomposition into q -tangles of a cube presentation of μ :

$$\mu = \left[\text{Diagram} \right]$$

Diagram: A rectangular box with two top semi-circular caps. It contains several vertical strands with arrows and crossings, representing a decomposition of the tangle μ .

Finally, let us consider (9.6). We need to compute $a := \iota(a_{(++)}) \in \hat{\mathbf{A}}(0, 2)$, where $a_{(++)} \in \mathcal{A}(\downarrow\downarrow)$ is the cabling anomaly. Since we have

$$a_{(++)} = Z \left(\text{Diagram 1} \right) = Z \left(\text{Diagram 2} \right) = Z \left(\text{Diagram 3} \right),$$

Diagram 1: A tangle with two strands crossing, labeled $a_{(++)}$.

Diagram 2: A tangle with two strands, one labeled $(++)$ and the other $(--)$.

Diagram 3: A complex tangle with multiple crossings and strands, representing a decomposition of the previous diagrams.

we obtain

$$a = \left[\text{Diagram} \right] \quad (9.7)$$

Diagram: A diagram with two vertical strands. The top strand has a loop labeled φ and the bottom strand has a loop labeled φ^{-1} . They are connected by several crossings.

Then (9.6) follows from (9.7) and the following decomposition into q -tangles of a cube presentation of Δ :

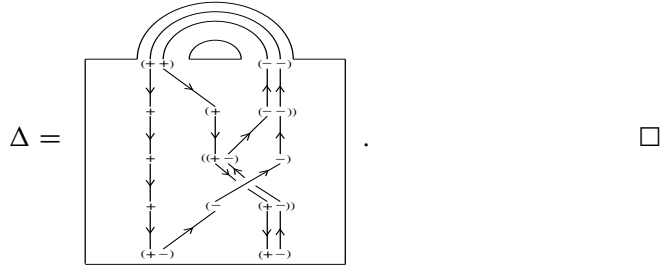

9.3. The braided monoidal functor $Z_q^\varphi: \mathcal{B}_q \rightarrow \widehat{\mathbf{A}}_q^\varphi$. Using the above computations of Z on the braiding and associativity isomorphisms of \mathcal{B}_q , we define a non-strict braided monoidal category $\widehat{\mathbf{A}}_q^\varphi$ as follows.

Let $\widehat{\mathbf{A}}_q$ denote the non-strictification of the linear strict monoidal category $\widehat{\mathbf{A}}$, see Section 3.3. (The non-strictification defined there extends to linear strict monoidal categories in the obvious way.) We identify $\text{Ob}(\widehat{\mathbf{A}}) = \mathbb{N}$ with $\text{Mon}(\bullet)$: consequently, $\text{Ob}(\widehat{\mathbf{A}}_q) = \text{Mag}(\bullet)$. The symmetry in $\widehat{\mathbf{A}}$ gives one in $\widehat{\mathbf{A}}_q$:

$$P_{v,w} := P_{|v|,|w|} \in \widehat{\mathbf{A}}_q(vw, wv) = \widehat{\mathbf{A}}(|v| + |w|, |w| + |v|) \quad \text{for } v, w \in \text{Mag}(\bullet).$$

Thus $\widehat{\mathbf{A}}_q$ is a linear symmetric non-strict monoidal category.

Using the Drinfeld associator $\varphi = \varphi(X, Y)$, we deform $\widehat{\mathbf{A}}_q$ into a linear braided non-strict monoidal category $\widehat{\mathbf{A}}_q^\varphi$ as follows. The underlying category, the tensor product functor and the monoidal unit of $\widehat{\mathbf{A}}_q^\varphi$ are the same as those of $\widehat{\mathbf{A}}_q$. The tensor product for $\widehat{\mathbf{A}}_q^\varphi$ is strictly unital, and the left and right unitality isomorphisms in $\widehat{\mathbf{A}}_q^\varphi$ are the identities. Define the associativity isomorphism $\alpha_{u,v,w}: (uv)w \rightarrow u(vw)$ by

$$\alpha_{u,v,w} := \quad , \tag{9.8}$$

and define the braiding $\psi_{v,w}: vw \rightarrow wv$ by

$$\psi_{v,w} := \quad . \tag{9.9}$$

The tensor-preserving functor $Z: \mathcal{B}_q \rightarrow \widehat{\mathbf{A}}$ is upgraded to a braided monoidal functor as follows.

Theorem 9.3. *With the above description, the category $\widehat{\mathbf{A}}_q^\varphi$ is braided monoidal and there is a (unique) braided monoidal functor*

$$Z_q^\varphi: \mathcal{B}_q \longrightarrow \widehat{\mathbf{A}}_q^\varphi \quad (9.10)$$

which is the identity on objects, such that

$$Z_q^\varphi(f) = Z(f) \in \widehat{\mathbf{A}}_q^\varphi(w, w') = \widehat{\mathbf{A}}(|w|, |w'|)$$

for morphisms $f: w \rightarrow w'$ in \mathcal{B}_q .

Proof. We can check that $\widehat{\mathbf{A}}_q^\varphi$ is a braided monoidal category using the properties of a Drinfeld associator (see Section 6.2). Alternatively, using the universality of Z proved in the next section, this follows since \mathcal{B}_q itself is a braided monoidal category and we have $Z(\psi_{v,w}) = \psi_{v,w}$, $Z(\alpha_{u,v,w}) = \alpha_{u,v,w}$; see (9.2) and (9.3).

Clearly, Z_q^φ is a well-defined functor. Since Z is tensor-preserving, so is Z_q^φ . By (9.2) and (9.3), Z_q^φ preserves the braidings and the associativity isomorphisms. Both \mathcal{B}_q and $\widehat{\mathbf{A}}_q^\varphi$ have the identity left and right unitality isomorphisms. Hence we have the assertion. \square

Remark 9.4. The braided monoidal structure of $\widehat{\mathbf{A}}_q^\varphi$ descends to a braided monoidal structure on the category $\widehat{\mathbf{A}}$, with the tensor product functor defined in Section 4.3, as follows. For $m, n, p \geq 0$, the associativity isomorphism $\alpha_{m,n,p}: (m+n)+p \rightarrow m+(n+p)$ and the braiding $\psi_{n,p}: n+p \rightarrow p+n$ are defined to be the right hand sides of (9.8) and (9.9), respectively, where we set $|u| = m$, $|v| = n$ and $|w| = p$. (Note that $\alpha_{m,n,p}$ and $\psi_{n,p}$ depend only on the choices of m, n, p and not on u, v, w .) Let $\widehat{\mathbf{A}}^\varphi$ denote the linear braided non-strict monoidal category thus obtained, with the identity left and right unitality isomorphisms. There is a fully faithful, linear braided monoidal functor

$$\pi: \widehat{\mathbf{A}}_q^\varphi \longrightarrow \widehat{\mathbf{A}}^\varphi$$

which maps each object $w \in \text{Mag}(\bullet)$ to its length, and maps the morphisms identically. Clearly, π is an equivalence of linear braided monoidal categories.

9.4. Transmutation of quasi-triangular quasi-Hopf algebras. In Section 9.5, we will interpret the formulas for Z in Proposition 9.2 in terms of transmutation. For a quasi-triangular Hopf algebra H , Majid introduced a Hopf algebra \underline{H} in the braided monoidal category \mathbf{Mod}_H of H -modules, called the *transmutation* of H [46, 47]. Here we consider transmutation of quasi-triangular quasi-Hopf algebras introduced by Klim [36].

Let $H = (H, \eta, \mu, \epsilon, \Delta, \varphi, S, \alpha, \beta, R)$ be a quasi-triangular quasi-Hopf algebra in a symmetric strict monoidal category \mathcal{C} with monoidal unit I . Following [36, Theorem 3.1], define morphisms

$$\underline{\eta}: I \rightarrow H, \quad \underline{\epsilon}: H \rightarrow I, \quad \underline{\mu}: H \otimes H \rightarrow H, \quad \underline{\Delta}: H \rightarrow H \otimes H, \quad \underline{S}: H \rightarrow H$$

in \mathcal{C} by

$$\underline{\eta} = \beta, \quad \underline{\epsilon} = \epsilon, \tag{9.11}$$

$$\underline{\mu}(b \otimes b') = q^1(x^1 \triangleright b)S(q^2)x^2b'S(x^3), \tag{9.12}$$

$$\underline{\Delta}(b) = x^1X^1b_{(1)}g^1S(x^2R^2y^3X^3_{(2)}) \otimes x^3R^1 \triangleright y^1X^2b_{(2)}g^2S(y^2X^3_{(1)}), \tag{9.13}$$

$$\underline{S}(b) = X^1R^2x^2\beta S(q^1(X^2R^1x^1 \triangleright b)S(q^2)X^3x^3), \tag{9.14}$$

where the adjoint action $\text{ad}: H \otimes H \rightarrow H$ is denoted by $l \otimes r \mapsto l \triangleright r$, we use Sweedler's notation $\Delta(z) = z_{(1)} \otimes z_{(2)}$ for $z \in H$, and we set

$$\begin{aligned} q &= q^1 \otimes q^2 = X^1 \otimes S^{-1}(\alpha X^3)X^2, \\ \varphi &= X^1 \otimes X^2 \otimes X^3, \quad \varphi^{-1} = x^1 \otimes x^2 \otimes x^3 = y^1 \otimes y^2 \otimes y^3, \\ g &= g^1 \otimes g^2 = (\Delta(S(x^1)\alpha x^2))\delta(S \otimes S)(\Delta^{\text{op}}(x^3)), \\ \delta &= \delta^1 \otimes \delta^2 = B^1\beta S(B^4) \otimes B^2\beta S(B^3), \\ B^1 \otimes B^2 \otimes B^3 \otimes B^4 &= (\Delta \otimes \text{id} \otimes \text{id})(\varphi)(\varphi^{-1} \otimes 1), \\ R &= R^1 \otimes R^2. \end{aligned}$$

Here we use the notations for a quasi-triangular quasi-Hopf algebra over a field, but the meaning of the above formulas in the category \mathcal{C} should be clear. Let $\underline{H} = (H, \text{ad})$ denote the object H with the adjoint action. Klim proved that $\underline{H} = (\underline{H}, \underline{\eta}, \underline{\mu}, \underline{\epsilon}, \underline{\Delta}, \underline{S})$ is a Hopf algebra in the braided monoidal category \mathbf{Mod}_H . (Recall that the monoidal category \mathbf{Mod}_H is not strict in general, although we assumed that \mathcal{C} is strict monoidal.)

By straightforward computation, we can rewrite (9.12) and (9.13) as follows.

Lemma 9.5. *We have*

$$\underline{\mu} = \mu\gamma_2\gamma_1, \quad (9.15)$$

$$\underline{\Delta} = \theta_5\theta_4\theta_3\theta_2\theta_1\Delta, \quad (9.16)$$

where we define $\gamma_1, \gamma_2, \theta_1, \dots, \theta_5: H^{\otimes 2} \rightarrow H^{\otimes 2}$ by

$$\begin{aligned} \gamma_1(b \otimes b') &= (x^1 \triangleright b) \otimes x^2 b' S(x^3), & \gamma_2(b \otimes b') &= X^1 b S(X^2) \alpha X^3 \otimes b', \\ \theta_1(b \otimes b') &= b g^1 \otimes b' g^2, & \theta_2(b \otimes b') &= X^1 b S(X^3_{(2)}) \otimes X^2 b' S(X^3_{(1)}), \\ \theta_3(b \otimes b') &= b S(y^3) \otimes y^1 b' S(y^2), & \theta_4(b \otimes b') &= b S(R^2) \otimes (R^1 \triangleright b'), \\ \theta_5(b \otimes b') &= x^1 b S(x^2) \otimes (x^3 \triangleright b'). \end{aligned}$$

9.5. Transmutation and the functor Z . Consider now the quasi-triangular quasi-Hopf algebra in $\widehat{\mathbf{A}}$

$$H := H_\varphi = (1, \eta, \mu, \epsilon, \Delta, \varphi, S, \alpha, \beta, R) \quad (9.17)$$

given by Theorem 6.2 with $\beta = \eta$ (and, hence, $\alpha = \nu$). Let $\underline{H} = (\underline{H}, \underline{\eta}, \underline{\mu}, \underline{\epsilon}, \underline{\Delta}, \underline{S})$ be the transmutation of H , which is a Hopf algebra in the braided non-strict monoidal category \mathbf{Mod}_H of H -modules in $\widehat{\mathbf{A}}$.

Let $H^{\mathcal{B}_q} = (\bullet, \eta, \mu, \epsilon, \Delta, S)$ denote the Hopf algebra in \mathcal{B}_q defined in Section 9.1. It follows from Theorem 9.3 that

$$Z_q^\varphi(H^{\mathcal{B}_q}) = (\bullet, Z_q^\varphi(\eta), Z_q^\varphi(\mu), Z_q^\varphi(\epsilon), Z_q^\varphi(\Delta), Z_q^\varphi(S))$$

is a Hopf algebra in the braided non-strict monoidal category $\widehat{\mathbf{A}}_q^\varphi$.

Next, we define a fully faithful linear functor

$$F: \widehat{\mathbf{A}}_q^\varphi \longrightarrow \mathbf{Mod}_H$$

by $F(w) = w(\underline{H})$ for $w \in \text{Mag}(\bullet)$ and

$$F(f) = f \quad \text{for } f \in \widehat{\mathbf{A}}_q^\varphi(v, w) = \widehat{\mathbf{A}}(|v|, |w|) \quad \text{with } v, w \in \text{Mag}(\bullet).$$

Then, by (9.8) and (9.9), F is a braided monoidal functor. Hence $F(Z_q^\varphi(H^{\mathcal{B}_q}))$ is a Hopf algebra in \mathbf{Mod}_H .

Theorem 9.6. *The two braided Hopf algebras $F(Z_q^\varphi(H^{\mathcal{B}_q}))$ and \underline{H} coincide.*

Proof. Since the antipode of a braided bialgebra is unique, it suffices to prove

$$Z(\eta) = \underline{\eta}, \quad Z(\epsilon) = \underline{\epsilon}, \quad Z(\mu) = \underline{\mu}, \quad Z(\Delta) = \underline{\Delta}.$$

It is easy to check the first two identities. We can check $Z(\mu) = \underline{\mu}$ by using (9.5), (9.15), and

$$\mu\gamma_2(b \otimes b') = X^1 b S(X^2) \nu X^3 b' \stackrel{(6.21)}{=} X^1 b S(X^2) X^3 b' \nu,$$

where, as before, b and b' are formal variables denoting virtual elements in the Hopf algebra.

Let us now prove $Z(\Delta) = \underline{\Delta}$. We have

$$\begin{aligned} g &= \Delta(S(x^1) \nu x^2) \delta \Delta(S(x^3)) \\ &\stackrel{(6.21)}{=} \Delta(S(x^1) \nu x^2) \Delta(S(x^3)) \delta \\ &= \Delta(S(x^1) \nu x^2 S(x^3)) \delta \\ &\stackrel{(6.7)}{=} \delta = X^1_{(1)} x^1 S(X^3) \otimes X^1_{(2)} x^2 S(x^3) S(X^2) \stackrel{(9.7)}{=} a. \end{aligned}$$

Hence, $\theta_1 \Delta(b) = \Delta(b) g = \Delta(b) a \stackrel{(6.21)}{=} a \Delta(b)$. Therefore,

$$\underline{\Delta}(b) \stackrel{(9.16)}{=} \theta_5 \cdots \theta_1 \Delta(b) = \theta_5 \cdots \theta_2 (a \Delta(b)) \stackrel{(9.6)}{=} Z(\Delta)(b)$$

where we use $P_{1,1} R = R$ in the last identity. Hence $\underline{\Delta} = Z(\Delta)$. □

9.6. Computations of Z up to degree 2. Here we give the values of Z for the generators of \mathcal{B}_q up to degree 2.

Proposition 9.7. We have $Z(\eta) = \img alt="Diagram of a square with a semi-circular arc at the bottom" data-bbox="461 681 523 718"}, $Z(\epsilon) = \img alt="Diagram of a square with a semi-circular arc at the top" data-bbox="629 681 691 718"/> and the following identities hold true up to degree 2:$$

$$\begin{aligned} Z(\mu) = & \img alt="Diagram of a square with two semi-circular arcs at the top and two vertical lines at the bottom" data-bbox="245 759 391 825"/> + \frac{1}{24} \img alt="Diagram of a square with two semi-circular arcs at the top, two vertical lines at the bottom, and a dashed semi-circular arc connecting the two vertical lines" data-bbox="465 759 611 825"/> + \frac{1}{48} \img alt="Diagram of a square with two semi-circular arcs at the top, two vertical lines at the bottom, and a dashed circle inside" data-bbox="685 759 831 825"/> \\ & - \frac{1}{48} \img alt="Diagram of a square with two semi-circular arcs at the top, two vertical lines at the bottom, and a dashed circle inside, with a different orientation" data-bbox="298 836 444 902"/> - \frac{1}{48} \img alt="Diagram of a square with two semi-circular arcs at the top, two vertical lines at the bottom, and a dashed circle inside, with a different orientation" data-bbox="514 836 660 902"/>, \end{aligned}$$

$$\begin{aligned}
 Z(\Delta) &= \begin{array}{c} \text{Diagram 1} \\ - \frac{1}{2} \text{Diagram 2} \\ + \frac{1}{8} \text{Diagram 3} \\ + \frac{1}{48} \text{Diagram 4} \\ - \frac{1}{12} \text{Diagram 5} \\ + \frac{1}{24} \text{Diagram 6} \\ + \frac{1}{24} \text{Diagram 7} \end{array}, \\
 Z(S^{\pm 1}) &= \begin{array}{c} \text{Diagram 1} \\ \pm \frac{1}{2} \text{Diagram 2} \\ \mp \frac{1}{2} \text{Diagram 3} \\ + \frac{1}{8} \text{Diagram 4} \\ - \frac{1}{4} \text{Diagram 5} \\ + \frac{1}{8} \text{Diagram 6} \end{array}, \\
 Z(r_{\pm}) &= \begin{array}{c} \text{Diagram 1} \\ \mp \frac{1}{2} \text{Diagram 2} \\ + \frac{1}{8} \text{Diagram 3} \end{array}, \\
 Z(\psi^{\pm 1}) &= \begin{array}{c} \text{Diagram 1} \\ \pm \frac{1}{2} \text{Diagram 2} \\ + \frac{1}{8} \text{Diagram 3} \end{array}, \\
 Z(\alpha_{u,v,w}^{\pm 1}) &= \begin{array}{c} \text{Diagram 1} \\ \mp \frac{1}{24} \text{Diagram 2} \end{array}.
 \end{aligned}$$

Proof. One can check these formulas by direct computations using Proposition 9.2 and the well-known identity

$$\varphi(X, Y) = 1 + \frac{1}{24}[X, Y] + (\text{terms of degree } > 2), \tag{9.18}$$

which follows from (6.15) and (6.16). We leave the details to the interested reader. \square

Remark 9.8. The quasi-triangular quasi-Hopf algebra $H = H_\varphi$ in $\widehat{\mathbf{A}}$ given in (9.17) has the following structure up to degree 2. The morphisms $\eta, \mu, \epsilon, \Delta, S$ are as depicted in (5.28) and concentrated in degree 0. Combining (6.17) to (9.18), using (6.18) and using (6.20), respectively, we obtain the following identities up to degree 2:

$$\begin{aligned} \varphi^{\pm 1} &= \boxed{\text{three arcs}} \mp \frac{1}{24} \boxed{\text{three arcs with a dashed triangle}}, \\ R^{\pm 1} &= \boxed{\text{two arcs}} \pm \frac{1}{2} \boxed{\text{two arcs with a dashed arc}} + \frac{1}{8} \boxed{\text{two arcs with two dashed arcs}}, \\ v &= \boxed{\text{one arc}} + \frac{1}{48} \boxed{\text{one arc with a dashed loop}}. \end{aligned}$$

We can also deduce Proposition 9.7 from these identities by using Theorem 9.6.

10. Universality of the extended Kontsevich integral

In this section, we show that the extended Kontsevich integral $Z_q^\varphi: \mathcal{B}_q \rightarrow \widehat{\mathbf{A}}_q^\varphi$ (given by Theorem 9.3) induces an isomorphism $Z_q^\varphi: \widehat{\mathbb{K}\mathcal{B}_q} \rightarrow \widehat{\mathbf{A}}_q^\varphi$ of linear braided monoidal categories, where $\widehat{\mathbb{K}\mathcal{B}_q}$ is the completion of the linearization $\mathbb{K}\mathcal{B}_q$ of \mathcal{B}_q with respect to the Vassiliev–Goussarov filtration. This implies the universality of Z among Vassiliev–Goussarov invariants of bottom tangles in handlebodies.

10.1. Ideals in monoidal categories. Let \mathcal{C} be a linear (possibly non-strict) monoidal category. We partly borrow from [31, §3.3] the following terminology. An *ideal* \mathcal{J} of \mathcal{C} consists of a family of linear subspaces $\mathcal{J}(v, w) \subset \mathcal{C}(v, w)$ for all $v, w \in \text{Ob}(\mathcal{C})$ such that $f \otimes g, f \circ g \in \mathcal{J}$ for morphisms $f, g \in \mathcal{C}$ with either $f \in \mathcal{J}$ or $g \in \mathcal{J}$. For instance, the ideal *generated* by a set S of morphisms of \mathcal{C} is the smallest ideal of \mathcal{C} containing S . Every ideal \mathcal{J} of \mathcal{C} defines a congruence relation in \mathcal{C} , and the quotient category \mathcal{C}/\mathcal{J} is a linear monoidal category.

A *filtration* \mathcal{F} in \mathcal{C} is a decreasing sequence $\mathcal{C} = \mathcal{F}^0 \supset \mathcal{F}^1 \supset \mathcal{F}^2 \supset \dots$ of ideals of \mathcal{C} such that $\mathcal{F}^k \circ \mathcal{F}^l \subset \mathcal{F}^{k+l}$ for $k, l \geq 0$. Then $\mathcal{F}^k \otimes \mathcal{F}^l \subset \mathcal{F}^{k+l}$ follows. The *completion of \mathcal{C} with respect to \mathcal{F}*

$$\widehat{\mathcal{C}}^\mathcal{F} := \varprojlim_k \mathcal{C}/\mathcal{F}^k$$

inherits a structure of filtered linear monoidal category from \mathcal{C} . Let $\widehat{\mathcal{F}}$ denote the filtration of $\widehat{\mathcal{C}}^{\mathcal{F}}$ induced by \mathcal{F} . Let $\text{Gr}^{\mathcal{F}}\mathcal{C}$ denote the graded linear monoidal category associated to \mathcal{F} : we have $\text{Ob}(\text{Gr}^{\mathcal{F}}\mathcal{C}) = \text{Ob}(\mathcal{C})$ and

$$\text{Gr}^{\mathcal{F}}\mathcal{C}(v, w) = \bigoplus_{k \geq 0} \mathcal{F}^k(v, w) / \mathcal{F}^{k+1}(v, w).$$

The product $\mathcal{J}\mathcal{J}$ of two ideals $\mathcal{J}, \mathcal{J} \subset \mathcal{C}$ is the ideal of \mathcal{C} generated by gf for all composable pairs of $g \in \mathcal{J}, f \in \mathcal{J}$. For an ideal $\mathcal{J} \subset \mathcal{C}$, the \mathcal{J} -adic filtration $\mathcal{C} = \mathcal{J}^0 \supset \mathcal{J}^1 \supset \mathcal{J}^2 \supset \dots$ of \mathcal{C} is defined inductively by $\mathcal{J}^0 = \mathcal{C}$ and $\mathcal{J}^{k+1} = \mathcal{J}\mathcal{J}^k$ for $k \geq 0$. We write $\widehat{\mathcal{C}} = \widehat{\mathcal{C}}^{\mathcal{J}}$ and $\text{Gr}\mathcal{C} = \text{Gr}^{\mathcal{J}}\mathcal{C}$ if the ideal \mathcal{J} is clear from the context. Note that \mathcal{J}^k contains all morphisms of \mathcal{C} that can be obtained by taking compositions and tensor products of a finite number of morphisms in \mathcal{C} containing at least k elements of \mathcal{J} .

We define the tensor power $w^{\otimes k}$ of an object w in \mathcal{C} inductively by $w^{\otimes 0} = I$, the monoidal unit, and $w^{\otimes(k+1)} = w^{\otimes k} \otimes w$. The tensor power $f^{\otimes k}: v^{\otimes k} \rightarrow w^{\otimes k}$ of a morphism $f: v \rightarrow w$ is defined similarly. (If \mathcal{C} is a strict monoidal category, then these tensor powers coincide with those we have already used.)

10.2. The Vassiliev–Goussarov filtration. We now generalize the Vassiliev–Goussarov filtration for links/tangles in a ball (see e.g. [6]) to bottom tangles in handlebodies. In the definition of the Vassiliev–Goussarov filtration, one usually uses only crossing-change moves to form alternating sums of tangles that generate the filtration. We here also use framing-change moves since we work with framed tangles.

Let $\mathbb{K}\mathcal{B}_q$ denote the linearization of the category \mathcal{B}_q . A *plot* P of a diagram D of a bottom q -tangle $T: v \rightarrow w$ is a disk in which D appears as either a crossing or a positive curl:

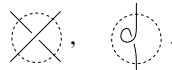

We get a new bottom q -tangle $T_P: v \rightarrow w$ from T by the following move at P :

$$T = \begin{array}{c} \text{---} \\ \diagdown \\ \diagup \\ \text{---} \end{array} \circlearrowleft \mapsto T_P = \begin{array}{c} \text{---} \\ \diagup \\ \diagdown \\ \text{---} \end{array} \circlearrowleft, \quad T = \begin{array}{c} \text{---} \\ \circlearrowright \\ \text{---} \end{array} \circlearrowleft \mapsto T_P = \begin{array}{c} \text{---} \\ | \\ \text{---} \end{array} \circlearrowleft. \quad (10.1)$$

More generally, if P is a finite set of pairwise disjoint plots of D , then we obtain a new bottom q -tangle T_P from T by applying the above move in each plot of P .

For $k \geq 0$, let $\mathcal{V}^k(v, w)$ denote the linear subspace of $\mathbb{K}\mathcal{B}_q(v, w)$ spanned by

$$[T; P] := \sum_{S \subset P} (-1)^{|S|} T_S,$$

where $T \in \mathcal{B}_q(v, w)$ and P is a set of k pairwise disjoint plots of an arbitrary diagram of T . The spaces $\mathcal{V}^k(v, w)$ give the *Vassiliev–Goussarov filtration* of $\mathbb{K}\mathcal{B}_q$:

$$\mathbb{K}\mathcal{B}_q = \mathcal{V}^0 \supset \mathcal{V}^1 \supset \mathcal{V}^2 \supset \dots.$$

As we will see, \mathcal{V} is a filtration of $\mathbb{K}\mathcal{B}_q$ in the sense of Section 10.1.

Recall from Section 9.1 the morphisms $\eta, r_+, r_- : \emptyset \rightarrow \bullet$ and $\mathbf{c} : \emptyset \rightarrow \bullet\bullet$ in \mathcal{B}_q . Let \mathcal{J} be the ideal of $\mathbb{K}\mathcal{B}_q$ generated by

$$r_+ - \eta \in \mathbb{K}\mathcal{B}_q(\emptyset, \bullet).$$

We have

$$\mathbf{c} - \eta^{\otimes 2} \in \mathcal{J}(\emptyset, \bullet\bullet). \quad (10.2)$$

Indeed, since $r_- = \mu(r_- \otimes \eta) \stackrel{\mathcal{J}}{\equiv} \mu(r_- \otimes r_+) = \eta$, we have

$$\mathbf{c} = (\mu(r_- \otimes \text{id}) \otimes \mu(\text{id} \otimes r_-)) \Delta r_+ \stackrel{\mathcal{J}}{\equiv} (\mu(\eta \otimes \text{id}) \otimes \mu(\text{id} \otimes \eta)) \Delta \eta = \eta^{\otimes 2}.$$

Now we give a categorical description of the Vassiliev–Goussarov filtration.

Proposition 10.1. *The Vassiliev–Goussarov filtration coincides with the \mathcal{J} -adic filtration; i.e., we have $\mathcal{V}^k = \mathcal{J}^k$ for $k \geq 0$.*

Proof. We first prove that \mathcal{V} is a filtration. It is easy to see that each \mathcal{V}^k is an ideal. To prove $\mathcal{V}^{k'} \circ \mathcal{V}^k \subset \mathcal{V}^{k+k'}$, consider morphisms $w \xrightarrow{T} w' \xrightarrow{T'} w''$ in \mathcal{B}_q , and let P (resp. P') consist of k (resp. k') pairwise disjoint plots of a diagram of T (resp. T'). We will prove $[T'; P'] \circ [T; P] \in \mathcal{V}^{k+k'}$. We can assume that the diagrams of T and T' arise from diagrams of some cube presentations U and U' of T and T' , respectively. Then

$$[T'; P'] \circ [T; P] = \sum_{S \subset P} \sum_{S' \subset P'} (-1)^{|S|+|S'|} T'_{S'} \circ T_S$$

has a cube presentation

$$\sum_{S \subset P} \sum_{S' \subset P'} (-1)^{|S|+|S'|} U'_{S'} \circ C_f(U_S) = [U'; P'] \circ C_f([U, P])$$

for some map $f: \pi_0(U) \rightarrow \text{Mag}(\pm)$. We can decompose the cabling of each of the moves in (10.1) into a finite sequence of moves in (10.1). Therefore we have

$$C_f([U, P]) = \sum_i [V_i, P_i],$$

where each V_i is a q -tangle differing from $C_f(U)$ only in the plots of P , and each P_i consists of k smaller plots in a diagram of V_i . It follows that

$$\sum_i [U'; P'] \circ [V_i, P_i] = \sum_i [U' \circ V_i; P' \cup P_i]$$

is a cube presentation of $[T'; P'] \circ [T; P]$. Hence it belongs to $\mathcal{V}^{k+k'}$.

Now we prove $\mathcal{J}^k = \mathcal{V}^k$ for $k \geq 1$. We have $\mathcal{J}^k \subset \mathcal{V}^k$ since \mathcal{V} is a filtration and we have $r_+ - \eta \in \mathcal{V}^1$. To prove $\mathcal{V}^k \subset \mathcal{J}^k$, consider an element $[T; P] \in \mathcal{V}^k(v, w)$, where $T \in \mathcal{B}_q(v, w)$ and P is a set of k pairwise disjoint plots of a diagram D of T . Assume that P has k' plots containing crossings and $k'' := k - k'$ plots containing positive curls. We can realize the moves in (10.1) by the moves $\eta^{\otimes 2} \mapsto \mathbf{c}$ and $\eta \mapsto r_+$. Thus, by moving the plots of P towards the upper right corner of D using planar isotopy and Reidemeister moves, we obtain

$$[T; P] = \pm T' \circ (\text{id}_v \otimes ((\mathbf{c} - \eta^{\otimes 2})^{\otimes k'} \otimes (r_+ - \eta)^{\otimes k''})),$$

where T' is a morphism in \mathcal{B}_q . By (10.2), it follows that $[T; P] \in \mathcal{J}^k$. \square

Remark 10.2. (1) One can define the filtrations \mathcal{V} and \mathcal{J} in $\mathbb{K}\mathcal{B}$ as well. Proposition 10.1 is valid in this setting, too.

(2) A result similar to Proposition 10.1 is given in [22]. The braided monoidal category \mathbb{B} defined there is a subcategory of the category \mathcal{T} of tangles, and there is a braided monoidal functor $\mathbb{B} \rightarrow \mathcal{B}$. The result [22, Theorem 9.19] essentially states that the Vassiliev–Goussarov filtration of the linearization $\mathbb{Z}\mathbb{B}$ of \mathbb{B} coincides with the $\mathcal{J}_{\mathbb{B}}$ -adic filtration, where $\mathcal{J}_{\mathbb{B}}$ is the ideal in $\mathbb{Z}\mathbb{B}$ generated by the morphism corresponding to $\eta^{\otimes 2} - \mathbf{c}$.

(3) In Sections 10.1 and 10.2, one can work over a commutative, unital ring. In particular, Proposition 10.1 holds for $\mathbb{Z}\mathcal{B}_q$ and $\mathbb{Z}\mathcal{B}$ as well.

Let $\widehat{\mathbb{K}\mathcal{B}}_q := \widehat{\mathbb{K}\mathcal{B}}_q^{\mathcal{V}} = \widehat{\mathbb{K}\mathcal{B}}_q^{\mathcal{J}}$, the completion of $\mathbb{K}\mathcal{B}_q$ with respect to the Vassiliev–Goussarov filtration or the \mathcal{J} -adic filtration. Let $\widehat{\mathbb{K}\mathcal{B}} = \widehat{\mathbb{K}\mathcal{B}}^{\mathcal{V}} = \widehat{\mathbb{K}\mathcal{B}}^{\mathcal{J}}$ be the completion of $\mathbb{K}\mathcal{B}$ similarly defined. Then $\widehat{\mathbb{K}\mathcal{B}}_q$ is naturally identified with the non-strictification $(\widehat{\mathbb{K}\mathcal{B}})_q$ of $\widehat{\mathbb{K}\mathcal{B}}$.

Let $\text{Gr } \mathbb{KB}_q$ denote the graded linear braided monoidal category associated to the filtration $\mathcal{V} = \mathcal{J}$ of \mathbb{KB}_q . The braidings $\psi_{v,w}$ in $\text{Gr } \mathbb{KB}_q$ are actually symmetries, i.e., we have $\psi_{w,v}\psi_{v,w} = \text{id}_{v,w}$ in $\text{Gr } \mathbb{KB}_q$. Indeed, since $\psi_{w,v}\psi_{v,w}$ and $\text{id}_{v,w}$ are related by finitely many crossing changes, we have

$$\psi_{w,v}\psi_{v,w} - \text{id}_{v \otimes w} \in \mathcal{V}^1.$$

Thus, $\text{Gr } \mathbb{KB}_q$ is a graded linear symmetric (non-strict) monoidal category. Similarly, $\text{Gr } \mathbb{KB}$ is a graded linear symmetric strict monoidal category.

10.3. The degree filtration of \mathbf{A}_q . Let \mathbf{A}_q denote the non-strictification of the linear strict monoidal category \mathbf{A} . The grading of \mathbf{A} induces that of \mathbf{A}_q . Thus \mathbf{A}_q has a *degree filtration*

$$\mathbf{A}_q = \mathcal{D}^0 \supset \mathcal{D}^1 \supset \mathcal{D}^2 \supset \dots$$

defined by

$$\mathcal{D}^k(v, w) = \bigoplus_{i \geq k} \mathbf{A}_i(|v|, |w|) \subset \mathbf{A}_q(v, w) \quad \text{for } k \geq 0, v, w \in \text{Mag}(\bullet).$$

Now we give a categorical description of the degree filtration \mathcal{D} . Each of the generators of the monoidal category \mathbf{A} provided by Theorem 5.11, say $f \in \mathbf{A}(m, n)$, have a lift in $f \in \mathbf{A}_q(\bullet^{\otimes m}, \bullet^{\otimes n})$. Let \mathcal{J} be the ideal of \mathbf{A}_q generated by the Casimir element $r \in \mathbf{A}_q(\emptyset, \bullet)$. Then \mathcal{J} is also generated by the Casimir 2-tensor $c \in \mathbf{A}_q(\emptyset, \bullet\bullet)$ since

$$r = \frac{1}{2}\mu c \quad \text{and} \quad c = \Delta r - r \otimes \eta - \eta \otimes r.$$

Proposition 10.3. *The degree filtration coincides with the \mathcal{J} -adic filtration; i.e., we have $\mathcal{D}^k = \mathcal{J}^k$ for $k \geq 0$.*

Proof. We have $\mathcal{J}^k \subset \mathcal{D}^k$ for $k \geq 0$ since \mathcal{D} is a filtration and we have $r \in \mathcal{D}^1$.

To prove $\mathcal{D}^k \subset \mathcal{J}^k$, consider a restricted chord diagram $D \in \mathcal{D}^k(v, w)$. By moving the k chords towards the top-right corner of a projection diagram of D , we obtain $D = D' \circ (\text{id}_v \otimes c^{\otimes k}) \in \mathcal{J}^k$, where D' is a morphism in \mathbf{A}_q . \square

Remark 10.4. We can define the filtrations \mathcal{D} and \mathcal{J} in the linear strict monoidal category \mathbf{A} as well. Proposition 10.3 is valid in this setting, too.

We can naturally identify $\widehat{\mathbf{A}}_q^{\mathcal{D}} = \widehat{\mathbf{A}}_q^{\mathcal{J}}$, namely the degree-completion or the \mathcal{J} -adic completion of \mathbf{A}_q , with the non-strictification $\widehat{\mathbf{A}}_q$ of $\widehat{\mathbf{A}}$ defined in Section 9.3.

It should not be confused with the monoidal category $\widehat{\mathbf{A}}_q^\varphi$, which is a deformation of $\widehat{\mathbf{A}}_q$ whose associativity isomorphisms involve a Drinfeld associator φ . However, $\widehat{\mathbf{A}}_q$ and $\widehat{\mathbf{A}}_q^\varphi$ have naturally identified underlying categories and tensor product functors. Thus we may regard the ideals $\widehat{\mathcal{D}}^k$ of $\widehat{\mathbf{A}}_q = \widehat{\mathbf{A}}_q^{\mathcal{D}}$ as ideals of $\widehat{\mathbf{A}}_q^\varphi$.

Consider the graded linear braided monoidal category $\text{Gr } \widehat{\mathbf{A}}_q^\varphi$ associated to the filtration $\widehat{\mathcal{D}}$ on $\widehat{\mathbf{A}}_q^\varphi$. We have the following.

Proposition 10.5. *The category $\text{Gr } \widehat{\mathbf{A}}_q^\varphi$ is symmetric monoidal, and is isomorphic to \mathbf{A}_q as a graded linear symmetric monoidal category. (Thus, the structure of $\text{Gr } \widehat{\mathbf{A}}_q^\varphi$ does not depend on the choice of φ .)*

Proof. The braiding $\psi_{v,w}$ in $\widehat{\mathbf{A}}_q^\varphi$ defined in (9.9) becomes symmetric in $\text{Gr } \widehat{\mathbf{A}}_q^\varphi$, i.e., $\psi_{w,v}\psi_{v,w} = \text{id}_{v \otimes w}$ in $\text{Gr } \widehat{\mathbf{A}}_q^\varphi$, since $\psi_{w,v}\psi_{v,w} - \text{id}_{v \otimes w} \in \widehat{\mathcal{D}}^1$. Thus, $\text{Gr } \widehat{\mathbf{A}}_q^\varphi$ is symmetric monoidal.

The associativity isomorphism $\alpha_{u,v,w}: (u \otimes v) \otimes w \rightarrow u \otimes (v \otimes w)$ in $\widehat{\mathbf{A}}_q^\varphi$ defined in (9.8) is congruent modulo $\widehat{\mathcal{D}}^1$ to the associativity isomorphism

$$\begin{aligned} \alpha_{u,v,w} &= \text{id} \in \widehat{\mathbf{A}}(|u| + |v| + |w|, |u| + |v| + |w|) \\ &= \widehat{\mathbf{A}}_q((u \otimes v) \otimes w, u \otimes (v \otimes w)) \end{aligned}$$

in $\widehat{\mathbf{A}}_q$. Similarly, the braiding $\psi_{u,v}: u \otimes v \rightarrow v \otimes u$ in $\widehat{\mathbf{A}}_q^\varphi$ defined in (9.9) is congruent modulo $\widehat{\mathcal{D}}^1$ to the symmetry $P_{u,v}: u \otimes v \rightarrow v \otimes u$ in $\widehat{\mathbf{A}}_q$. Hence $\text{Gr } \widehat{\mathbf{A}}_q^\varphi$ is isomorphic to $\text{Gr } \widehat{\mathbf{A}}_q = \mathbf{A}_q$ as a linear symmetric monoidal category. \square

In the following we identify $\text{Gr } \widehat{\mathbf{A}}_q^\varphi$ with \mathbf{A}_q .

10.4. Universality of Z_q^φ . We first check that Z_q^φ is filtration-preserving.

Proposition 10.6. *The functor $Z_q^\varphi: \mathbb{K}\mathcal{B}_q \rightarrow \widehat{\mathbf{A}}_q^\varphi$ induced by $Z_q^\varphi: \mathcal{B}_q \rightarrow \widehat{\mathbf{A}}_q^\varphi$ preserves filtrations; i.e., $Z_q^\varphi(\mathcal{V}^k) \subset \widehat{\mathcal{D}}^k$ for $k \geq 0$. Hence Z_q^φ induces a filtered linear braided monoidal functor*

$$Z_q^\varphi: \widehat{\mathbb{K}\mathcal{B}}_q \longrightarrow \widehat{\mathbf{A}}_q^\varphi. \quad (10.3)$$

Proof. Since $r_+ - \eta$ generates the ideal $\mathcal{J} = \mathcal{V}^1 \subset \mathbb{K}\mathcal{B}_q$, since we have

$$Z_q^\varphi(r_+ - \eta) \stackrel{(9.2)}{=} \mathbf{r}^{-1} - \eta = -r + (\deg \geq 2) \in \widehat{\mathcal{D}}^1, \quad (10.4)$$

and since Z_q^φ is a monoidal functor, it follows that $Z_q^\varphi(\mathcal{V}^1) \subset \widehat{\mathcal{D}}^1$. Hence,

$$Z_q^\varphi(\mathcal{V}^k) \subset Z_q^\varphi(\mathcal{V}^1)^k \subset (\widehat{\mathcal{D}}^1)^k \subset \widehat{\mathcal{D}}^k. \quad \square$$

By Proposition 10.6, $Z_q^\varphi: \widehat{\mathbb{K}\mathcal{B}_q} \rightarrow \widehat{\mathbf{A}}_q^\varphi$ induces a graded linear braided monoidal functor

$$\mathrm{Gr} Z_q^\varphi: \mathrm{Gr} \mathbb{K}\mathcal{B}_q \longrightarrow \mathrm{Gr} \widehat{\mathbf{A}}_q^\varphi = \mathbf{A}_q.$$

We already know that both $\mathrm{Gr} \mathbb{K}\mathcal{B}_q$ and $\mathrm{Gr} \widehat{\mathbf{A}}_q^\varphi = \mathbf{A}_q$ are symmetric monoidal. Thus, $\mathrm{Gr} Z_q^\varphi$ is a graded linear *symmetric* monoidal functor. Recall that $\mathrm{Gr} \mathbb{K}\mathcal{B}_q$ and \mathbf{A}_q are the non-strictifications of $\mathrm{Gr} \mathbb{K}\mathcal{B}$ and \mathbf{A} , respectively. It is easy to see that the functor $\mathrm{Gr} Z_q^\varphi$ is the non-strictification of a unique graded linear symmetric monoidal functor

$$\bar{Z}: \mathrm{Gr} \mathbb{K}\mathcal{B} \longrightarrow \mathbf{A}.$$

More concretely, we can define \bar{Z} by

$$\bar{Z}(t) := (\text{degree } k \text{ part of } Z_q^\varphi(t_q))$$

for $t \in \mathcal{V}^k(m, n)$, $m, n, k \geq 0$, where $t_q = t \in \mathcal{V}^k(\bullet^{\otimes m}, \bullet^{\otimes n}) \subset \mathbb{K}\mathcal{B}_q(\bullet^{\otimes m}, \bullet^{\otimes n})$.

Theorem 10.7. *The functor $\mathrm{Gr} Z_q^\varphi: \mathrm{Gr} \mathbb{K}\mathcal{B}_q \rightarrow \mathbf{A}_q$ is an isomorphism of graded linear symmetric (non-strict) monoidal categories. The functor $\bar{Z}: \mathrm{Gr} \mathbb{K}\mathcal{B} \rightarrow \mathbf{A}$ is an isomorphism of graded linear symmetric strict monoidal categories.*

Proof. It suffices to prove the latter assertion, since the former corresponds to the latter by non-strictification.

Let $H^\mathcal{B} = (1, \mu, \eta, \Delta, \epsilon, S)$ be the Hopf algebra in \mathcal{B} defined in Section 9.1. It induces a Hopf algebra $H^{\mathrm{Gr}\mathbb{K}\mathcal{B}} = (1, \mu, \eta, \Delta, \epsilon, S)$ in $\mathrm{Gr} \mathbb{K}\mathcal{B}$, concentrated in the degree 0 part $\mathrm{Gr}^0 \mathbb{K}\mathcal{B} = \mathcal{V}^0/\mathcal{V}^1$.

Let us prove that $H^{\mathrm{Gr}\mathbb{K}\mathcal{B}}$ has a Casimir Hopf algebra structure. Since Δ and $\psi_{1,1}\Delta$ in \mathcal{B} are related by some crossing changes, we have $\Delta - \psi_{1,1}\Delta \in \mathcal{V}^1(1, 2)$, i.e., $\Delta = \psi_{1,1}\Delta$ in $\mathrm{Gr} \mathbb{K}\mathcal{B}$. Thus $H^{\mathrm{Gr}\mathbb{K}\mathcal{B}}$ is cocommutative. Furthermore,

$$\tilde{\mathbf{c}} := \mathbf{c} - \eta^{\otimes 2} \in \mathcal{V}^1(0, 2)$$

gives a Casimir 2-tensor for H^{GrKB} . Indeed, the identities in \mathcal{B}

$$\begin{aligned}(\Delta \otimes \text{id}_1)\mathbf{c} &= (\text{id}_2 \otimes \mu)(\text{id}_1 \otimes \mathbf{c} \otimes \text{id}_1)\mathbf{c}, \\ \psi\mathbf{c} &= (\text{ad} \otimes \text{id}_1)(r_+ \otimes \mathbf{c}), \\ \mathbf{c}\epsilon &= (\text{ad} \otimes \text{ad})(\text{id}_1 \otimes \psi \otimes \text{id}_1)(\Delta \otimes \mathbf{c})\end{aligned}$$

imply

$$\begin{aligned}(\Delta \otimes \text{id}_1)\tilde{\mathbf{c}} - (\text{id}_1 \otimes \eta \otimes \text{id}_1)\tilde{\mathbf{c}} - \eta \otimes \tilde{\mathbf{c}} &= (\text{id}_2 \otimes \mu)(\text{id}_1 \otimes \tilde{\mathbf{c}} \otimes \text{id}_1)\tilde{\mathbf{c}} \in \mathcal{V}^2(0, 3), \\ \psi\tilde{\mathbf{c}} - \tilde{\mathbf{c}} = \psi\mathbf{c} - \mathbf{c} &= (\text{ad} \otimes \text{id}_1)((r_+ - \eta) \otimes \tilde{\mathbf{c}}) \in \mathcal{V}^2(0, 2), \\ \tilde{\mathbf{c}}\epsilon &= (\text{ad} \otimes \text{ad})(\text{id}_1 \otimes \psi \otimes \text{id}_1)(\Delta \otimes \tilde{\mathbf{c}}),\end{aligned}$$

respectively. By Theorem 5.11, there is a unique symmetric monoidal functor

$$G: \mathbf{A} \longrightarrow \text{GrKB}$$

which maps the Casimir Hopf algebra $(H^{\mathbf{A}}, c)$ in \mathbf{A} to the Casimir Hopf algebra $(H^{\text{GrKB}}, -\tilde{\mathbf{c}})$ in GrKB .

We prove that G is full. By Proposition 10.1, GrKB is generated by its degree 0 part $\mathcal{V}^0/\mathcal{V}^1$ and its degree 1 part $\mathcal{V}^1/\mathcal{V}^2$. We have $\mathcal{V}^0/\mathcal{V}^1 = G(\mathbf{A}_0)$ since $\mathcal{V}^0/\mathcal{V}^1$ (resp. \mathbf{A}_0) is generated by the Hopf algebra H^{GrKB} (resp. $H^{\mathbf{A}}$). Thus it suffices to prove $\mathcal{V}^1/\mathcal{V}^2 = \mathcal{J}^1/\mathcal{J}^2 \subset G(\mathbf{A}_1)$. As an ideal of KB/\mathcal{J}^2 , \mathcal{J} is generated by $\tilde{r}_+ := r_+ - \eta \in \mathcal{J}^1/\mathcal{J}^2$. Hence it suffices to check $\tilde{r}_+ \in G(\mathbf{A}_1)$. Since $\mu(r_+ \otimes r_+) = \mu\mathbf{c} \in \mathcal{B}(0, 1)$, we have

$$\mathcal{J}^2 \ni \mu(\tilde{r}_+ \otimes \tilde{r}_+) = \mu\mathbf{c} - 2r_+ + \eta = \mu\tilde{\mathbf{c}} - 2\tilde{r}_+.$$

Therefore,

$$G(r) = G\left(\frac{1}{2}\mu\mathbf{c}\right) = \frac{1}{2}G(\mu)G(c) = -\frac{1}{2}\mu\tilde{\mathbf{c}} = -\tilde{r}_+. \quad (10.5)$$

The linear symmetric monoidal functor $\bar{Z}G: \mathbf{A} \rightarrow \mathbf{A}$ preserves $H^{\mathbf{A}}$. Moreover, (10.4) and (10.5) imply $\bar{Z}G(r) = r$. Thus $\bar{Z}G$ is the identity on the generators of \mathbf{A} ; hence $\bar{Z}G = \text{id}_{\mathbf{A}}$. Therefore \bar{Z} is an isomorphism. \square

We conclude this section with a stronger version of Theorem 10.7 and two remarks about it.

Theorem 10.8. *The functor $Z_q^\varphi: \widehat{\text{KB}}_q \rightarrow \widehat{\mathbf{A}}_q^\varphi$ is an isomorphism of filtered linear braided (non-strict) monoidal categories.*

Proof. Theorem 10.7 and an induction on k shows that

$$Z_q^\varphi: \widehat{\mathbb{K}\mathcal{B}_q} / \widehat{\mathcal{V}}^{k+1} \longrightarrow \widehat{\mathbf{A}}_q^\varphi / \widehat{\mathcal{D}}^{k+1}$$

is an isomorphism for all $k \geq 0$. Hence

$$Z_q^\varphi: \widehat{\mathbb{K}\mathcal{B}_q} \longrightarrow \widehat{\mathbf{A}}_q^\varphi$$

is an isomorphism. \square

Remark 10.9. The map $G: \mathbf{A}(m, n) \rightarrow (\text{Gr } \mathbb{K}\mathcal{B})(m, n)$, $m, n \geq 0$, defined in the proof of Theorem 10.7 can also be constructed as a direct sum of maps

$$G_d: \mathbf{A}(m, n)_d \longrightarrow (\text{Gr } \mathbb{K}\mathcal{B})(m, n)_d$$

indexed by $d \in \mathbf{F}(n, m)$, using calculus of claspers instead of the presentation of \mathbf{A} . More precisely, the map G_d is defined by *fixing* an n -component bottom tangle γ_d in V_m of homotopy class d , and by realizing every (m, n) -Jacobi diagram D of homotopy class d as a “simple strict graph clasper” C_D on γ_d in the sense of [21]. Then $G_d(D)$ is defined as the alternating sum of clasper surgeries on the connected components of C_D . See [21, §8.2] for the special case $m = 0$.

Remark 10.10. Theorem 10.8 implies the universal property of Z and Z_q^φ among \mathbb{K} -valued Vassiliev–Goussarov invariants of bottom tangles in handlebodies. For links in handlebodies (and, more generally, for links in thickened surfaces), similar results have been obtained in [3, 42].

11. Relationship with the LMO functor

In this section, we explain how the extended Kontsevich integral relates to the LMO functor introduced in [9].

11.1. Review of the LMO functor. The LMO functor as defined in [9]

$$\tilde{Z}: \mathcal{L}\text{Cob}_q \longrightarrow {}^{\text{ts}}\mathcal{A}$$

is a functor from the category $\mathcal{L}\text{Cob}_q$ of Lagrangian q -cobordisms to (the degree-completion of) the category ${}^{\text{ts}}\mathcal{A}$ of “top-substantial Jacobi diagrams”. Here we consider the restriction of \tilde{Z} to the category ${}^s\mathcal{L}\text{Cob}_q \cong \mathcal{B}_q$ of *special Lagrangian q -cobordisms*, which is the non-strictification of the strict monoidal category ${}^s\mathcal{L}\text{Cob} \cong \mathcal{B}$ recalled in Section 2.4. By [9, Corollary 5.4], it turns out that \tilde{Z} on

${}^s\mathcal{L}Cob$ takes values in a subcategory ${}^s\mathcal{A}$ of ${}^t\mathcal{A}$, which we call the category of *special (top-substantial) Jacobi diagrams*. Thus, we here consider the restricted version of the LMO functor:

$$\tilde{Z}: {}^s\mathcal{L}Cob_q \longrightarrow {}^s\mathcal{A}.$$

The category ${}^s\mathcal{A}$ is defined as follows. Set $\text{Ob}({}^s\mathcal{A}) = \mathbb{N}$. Given a finite set U , a U -labeled Jacobi diagram is a univalent graph with oriented trivalent vertices, with each univalent vertex labeled by an element of U . We identify two U -labeled Jacobi diagrams if there is a homeomorphism from one to the other preserving the vertex-orientations and the labelings. Let $\mathcal{A}(U)$ denote the vector space generated by U -labeled Jacobi diagrams modulo the AS and IHX relations (3.4). For $m, n \geq 0$, let ${}^s\mathcal{A}(m, n)$ be the subspace of

$$\mathcal{A}(\{1^+, \dots, m^+\} \cup \{1^-, \dots, n^-\})$$

spanned by *special Jacobi diagrams*, which are those diagrams with no connected component without labels in $\{1^-, \dots, n^-\}$. (Recall that a *top-substantial Jacobi diagram* in [9] allows such connected components that are not struts. Thus, we have ${}^s\mathcal{A}(m, n) \subset {}^t\mathcal{A}(m, n)$, where ${}^t\mathcal{A}(m, n)$ is the space of top-substantial Jacobi diagrams.) The composition $D' \circ D$ of two special Jacobi diagrams $m \xrightarrow{D} n \xrightarrow{D'} p$ in ${}^s\mathcal{A}$ is the sum of all possible ways of gluing some i^- -vertices of D with some i^+ -vertices of D' for all $i \in \{1, \dots, n\}$. Define the identity morphisms in ${}^s\mathcal{A}$ by

$$\text{id}_m = \exp_{\sqcup} \left(\sum_{i=1}^m \binom{i^+}{i^-} \right) : m \longrightarrow m,$$

where \sqcup denotes the disjoint union of Jacobi diagrams.

The category ${}^s\mathcal{A}$ has a strict monoidal structure such that $m \otimes m' = m + m'$ for $m, m' \geq 0$, and the tensor product $D \otimes D'$ of two special Jacobi diagrams D and D' is the disjoint union $D \sqcup D'$ with the appropriate re-numbering of the colors of D' . The category ${}^s\mathcal{A}$ is graded, where the *degree* of a special Jacobi diagram is half the total number of vertices. The degree-completion of ${}^s\mathcal{A}$ is also denoted by ${}^s\mathcal{A}$.

The *LMO functor* is a functor $\tilde{Z}: {}^s\mathcal{L}Cob_q \rightarrow {}^s\mathcal{A}$ with the following properties.

- (i) We have $\tilde{Z}(w) = |w|$ for $w \in \text{Mag}(\bullet)$.
- (ii) Let $T \in \mathcal{B}_q(\emptyset, w) \subset \mathcal{T}_q(\emptyset, w(+))$ with $w \in \text{Mag}(\bullet)$, $|w| = n$ and let $E_T \in {}^s\mathcal{L}Cob_q(\emptyset, w)$ be the cobordism corresponding to T . Then we have $\tilde{Z}(E_T) = \chi^{-1}Z(T)$, where $Z(T)$ is the usual Kontsevich integral (as defined in Section 3.7) and

$$\chi: {}^s\mathcal{A}(0, n) \xrightarrow{\cong} \mathcal{A}(X_n)$$

is the diagrammatic analog of the PBW isomorphism (see [4]). Here, recall $X_n = \curvearrowleft_1 \cdots \curvearrowright_n$.

(iii) For morphisms T and T' in $\mathcal{L}Cob_q$, we have $\tilde{Z}(T \otimes T') = \tilde{Z}(T) \otimes \tilde{Z}(T')$.

11.2. From the extended Kontsevich integral to the LMO functor. For two integers $m, n \geq 0$, define a linear map $\kappa: \mathbf{A}(m, n) \rightarrow {}^s\mathcal{A}(m, n)$ by

$$\kappa \left(\begin{array}{c} \text{Diagram with } m \text{ handles and } n \text{ strands} \end{array} \right) := \chi^{-1} \left(\begin{array}{c} \text{Diagram with } m \text{ handles, } n \text{ strands, and exponential labels } \exp(1^+) \text{ and } \exp(m^+) \end{array} \right),$$

where an $F(x_1, \dots, x_m)$ -colored Jacobi diagram on X_n , is presented by a projection diagram in the square with handles. By the IHX and STU relations, κ is well-defined. Note that κ is an analog of the ‘‘hair map’’ considered by Garoufalidis, Kricker and Rozansky in [16, 18].

Proposition 11.1. *The maps $\kappa: \mathbf{A}(m, n) \rightarrow {}^s\mathcal{A}(m, n)$ for $m, n \geq 0$ define a monoidal functor $\kappa: \mathbf{A} \rightarrow {}^s\mathcal{A}$, which induces a monoidal functor $\kappa: \hat{\mathbf{A}} \rightarrow {}^s\mathcal{A}$ by continuity.*

Proof. Consider two restricted Jacobi diagrams D and D' with square presentations S and S' , respectively:

$$D' = \begin{array}{c} \text{Diagram with } n \text{ handles and } p \text{ strands} \\ \in \mathbf{A}(n, p), \end{array}$$

$$D = \begin{array}{c} \text{Diagram with } m \text{ handles and } n \text{ strands} \\ \in \mathbf{A}(m, n). \end{array}$$

In what follows, we express exponentials with square brackets and, given two Jacobi diagrams E and E' labeled by the finite sets $\{1^-, \dots, n^-\}$ and $\{1^+, \dots, n^+\}$,

respectively, let $\langle E', E \rangle$ denote the sum of all possible ways of gluing some i^- -vertices of E with some i^+ -vertices of E' for all $i \in \{1, \dots, n\}$. Then $\kappa(D') \circ \kappa(D)$ is equal to

$$\begin{aligned}
 & \kappa \left(\begin{array}{c} \text{Diagram 1: Box } S' \text{ with } n \text{ arcs } (1, \dots, n) \text{ and } p \text{ outputs } (1, \dots, p) \end{array} \right) \circ \kappa \left(\begin{array}{c} \text{Diagram 2: Box } S \text{ with } m \text{ arcs } (1, \dots, m) \text{ and } n \text{ outputs } (1, \dots, n) \end{array} \right) \\
 &= \left\langle \chi^{-1} \left(\begin{array}{c} \text{Diagram 3: Box } S' \text{ with } [1^+ \dots] \text{ and } [m^+ \dots] \text{ arcs and } p \text{ outputs} \end{array} \right), \chi^{-1} \left(\begin{array}{c} \text{Diagram 4: Box } S \text{ with } [1^+ \dots] \text{ and } [m^+ \dots] \text{ arcs and } n \text{ outputs} \end{array} \right) \right\rangle \\
 &= \chi^{-1} \left(\left\langle \begin{array}{c} \text{Diagram 3} \\ \text{Diagram 4} \end{array} \right\rangle \right) \\
 &= \chi^{-1} \left(\begin{array}{c} \text{Diagram 5: Box } S' \text{ with } \uparrow\uparrow\uparrow \text{ and } \downarrow\downarrow\downarrow \text{ markings and } p \text{ outputs} \\ \circ C_f \left(\begin{array}{c} \text{Diagram 4} \end{array} \right) \end{array} \right) \\
 &= \chi^{-1} \left(\begin{array}{c} \text{Diagram 5} \\ \circ \begin{array}{c} \text{Diagram 4} \\ \text{Diagram 6: Box } C_f(S) \text{ with } \uparrow\uparrow\uparrow \text{ and } \downarrow\downarrow\downarrow \text{ markings and } n \text{ outputs} \end{array} \end{array} \right) \\
 &= \chi^{-1} \left(\begin{array}{c} \text{Diagram 7: Box } S' \circ C_f(S) \text{ with } [1^+ \dots] \text{ and } [m^+ \dots] \text{ arcs and } p \text{ outputs} \end{array} \right) = \kappa \left(\begin{array}{c} \text{Diagram 2} \end{array} \right),
 \end{aligned}$$

where the last four \circ denote compositions in \mathcal{A} , and $f: \pi_0(S) \rightarrow \text{Mon}(\pm)$ is an appropriate map. We deduce from Example 4.10 that $\kappa(D') \circ \kappa(D) = \kappa(D' \circ D)$. We can easily check $\kappa(\text{id}_m) = \text{id}_m$ for $m \geq 0$. Thus we obtain a functor $\kappa: \mathbf{A} \rightarrow {}^s\mathcal{A}$, which is obviously monoidal. \square

Theorem 11.2. *The following square of functors commutes:*

$$\begin{array}{ccc}
 \mathcal{B}_q & \xrightarrow{Z} & \widehat{\mathbf{A}} \\
 \cong \downarrow & & \downarrow \kappa \\
 {}^s\mathcal{L}\mathcal{Cob}_q & \xrightarrow{\bar{Z}} & {}^s\mathcal{A}
 \end{array} \tag{11.1}$$

Proof. Let $T: v \rightarrow w$ in \mathcal{B}_q , $|v| = m$, $|w| = n$, and let $U: d^v(v_1, \dots, v_m) \rightarrow w(+\dots-)$ in \mathcal{T}_q be a cube presentation of T . Then $\kappa(Z(T))$ is equal to

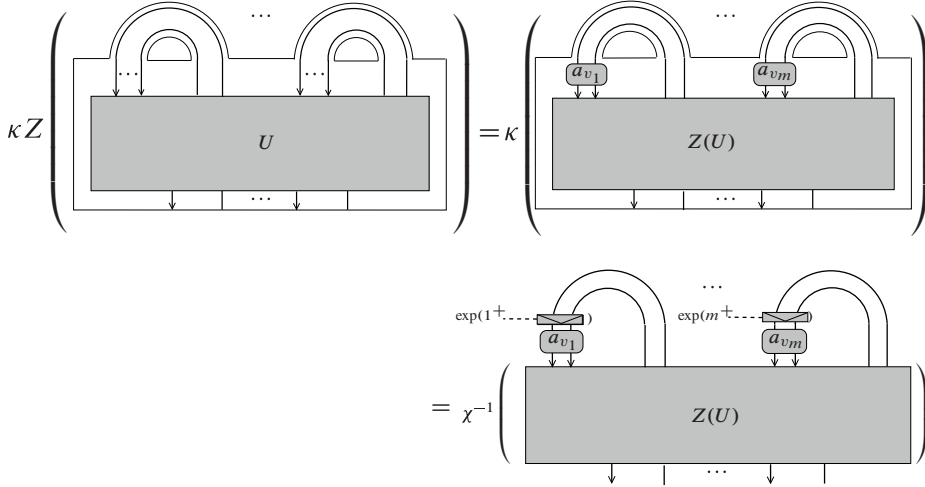

and the result directly follows from [9, Lemma 5.5]. □

Theorem 11.2 shows that the extended Kontsevich integral Z dominates the LMO functor \tilde{Z} . However, the converse might not hold since, as we will see in the next subsection, the functor κ is not faithful. Some other remarks about the functor κ follow.

Remark 11.3. Theorem 1.5 in Section 1 is stated in a way slightly different from Theorem 11.2. In fact, the latter differs from the former simply because we have restricted the source of \tilde{Z} to ${}^s\mathcal{L}Cob_q \subset \mathcal{L}Cob_q$ and its target to ${}^s\mathcal{A} \subset {}^t\mathcal{A}$.

Remark 11.4. Several interesting structures in \mathbf{A} (and $\hat{\mathbf{A}}$) are mapped by κ into the categories ${}^s\mathcal{A}$ and ${}^t\mathcal{A}$. For instance, the symmetry $P_{m,n}: m + n \rightarrow n + m$ in (4.11) is mapped to a symmetry

$$P_{m,n} := \exp_{\square} \left(\sum_{i=1}^m \binom{i^+}{(n+i)^-} + \sum_{j=1}^n \binom{(m+j)^+}{j^-} \right); m + n \longrightarrow n + m$$

for the strict monoidal category ${}^s\mathcal{A}$ (resp. ${}^t\mathcal{A}$). Similarly, the braided monoidal structure of $\hat{\mathbf{A}}_q^\varphi$ is mapped by κ into a braided monoidal structure on the non-strictification of ${}^s\mathcal{A}$ (resp. ${}^t\mathcal{A}$). The Casimir Hopf algebra in \mathbf{A} (given by Proposition 5.10) and the ribbon quasi-Hopf algebra in $\hat{\mathbf{A}}$ (given by Theorem 6.2) are mapped by κ into such structures in ${}^s\mathcal{A}$, and hence in ${}^t\mathcal{A}$.

Remark 11.5. Recall from Section 4.5 that the categories \mathbf{A} and $\widehat{\mathbf{A}}$ are enriched over the category \mathbf{CC} of cocommutative coalgebras. It is not difficult to verify that the categories ${}^{\text{ts}}\mathcal{A}$ and ${}^{\text{s}}\mathcal{A}$ are enriched over \mathbf{CC} , with the coalgebra structure on the morphism spaces described in [9], where connected Jacobi diagrams are primitive as usual. Then one can check that the “hair functor” $\kappa: \widehat{\mathbf{A}} \rightarrow {}^{\text{s}}\mathcal{A}$ is a \mathbf{CC} -functor, i.e., the maps $\kappa: \widehat{\mathbf{A}}(m, n) \rightarrow {}^{\text{s}}\mathcal{A}(m, n)$ are coalgebra maps. By applying the “group-like part functor” $\text{grp}: \mathbf{CC} \rightarrow \mathbf{Set}$, we obtain a group-like version of κ :

$$\kappa^{\text{grp}}: \widehat{\mathbf{A}}^{\text{grp}} \longrightarrow {}^{\text{s}}\mathcal{A}^{\text{grp}}.$$

11.3. Non-faithfulness of κ . Using Vogel’s results [63], Patureau-Mirand has proved that the “hair map” in [16, 18] is not injective [55, Theorem 4]. The next proposition is proved by adapting his arguments to our situation.

Theorem 11.6. *If $m, n \geq 1$, then $\kappa: \mathbf{A}(m, n) \rightarrow {}^{\text{s}}\mathcal{A}(m, n)$ is not injective, and therefore, neither is $\kappa: \widehat{\mathbf{A}}(m, n) \rightarrow {}^{\text{s}}\mathcal{A}(m, n)$.*

Proof. Let $G(n)$ be the subspace of $\mathcal{A}(\{1, \dots, n\})$ spanned by connected Jacobi diagrams with exactly n univalent vertices labeled from 1 to n . There is a natural action of the symmetric group \mathfrak{S}_n on $G(n)$, and we consider the subspace Λ of $G(3)$ consisting of those $x \in G(3)$ such that $\sigma \cdot x = \text{sgn}(\sigma)x$ for all $\sigma \in \mathfrak{S}_3$. According to Vogel [63], the space Λ admits a structure of commutative algebra with non-trivial zero divisors. Based on these results, Patureau-Mirand [55, Corollary 2] proved the existence of an element $r \in \Lambda \setminus \{0\}$ of degree 17 such that

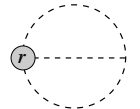

$$\neq 0 \in \mathcal{A}(\emptyset), \tag{11.2}$$

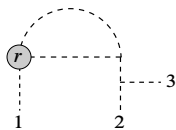

$$= 0 \in G(3). \tag{11.3}$$

Then we define

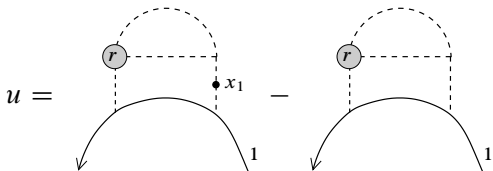

$$u = \in \mathcal{A}(X_1, F(x_1)) = \mathbf{A}(1, 1).$$

By (11.3), we have $\chi(\kappa(u)) = 0 \in \mathcal{A}(X_1, \{1^+\})$, and hence $\kappa(u) = 0$. More generally, if $m, n \geq 1$, then $\kappa: \mathbf{A}(m, n) \rightarrow {}^{\text{s}}\mathcal{A}(m, n)$ vanishes on $u \otimes \eta^{\otimes(n-1)} \epsilon^{\otimes(m-1)}$. Thus, to prove that it is not injective, it suffices to check $u \neq 0$.

Recall the projection $p: \mathcal{A}(X_1, F(x_1)) \rightarrow \mathcal{A}(X_1)$ introduced in the proof of Lemma 4.5. We have

$$\chi^{-1}(p(u)) = -\chi^{-1} \left(\text{Diagram 1} \right) = - \text{Diagram 2} \in \mathcal{A}(\{1\}),$$

since $G(1) = 0$ [63, Proposition 4.3]. By (11.2), the right hand side is not zero, and hence we have $u \neq 0$. □

11.4. Jacobi diagrams colored by a cocommutative Hopf algebra. In order to give a Hopf-algebraic description of the kernel of κ in the next subsection, we need to generalize some constructions of Section 4.1.

Let X be a compact oriented 1-manifold, and let H be a cocommutative Hopf algebra with comultiplication $\Delta: H \rightarrow H \otimes H$, counit $\epsilon: H \rightarrow \mathbb{K}$ and (involutive) antipode $S: H \rightarrow H$.

Recall from Section 4.1 the notion of chord diagrams colored by a set. Let $\mathcal{D}^{\text{ch}}(X, H)$ be the vector space generated by H -colored chord diagrams on X , modulo the following local relations:

$$\begin{aligned}
 & \overline{kx+ly} \leftrightarrow k \overline{x} + l \overline{y}, \\
 & \cdots \overline{kx+ly} \leftrightarrow k \cdots \overline{x} + l \cdots \overline{y}, \\
 & \overline{x \ y} \leftrightarrow \overline{xy} \quad , \quad \overline{1} \leftrightarrow \longrightarrow , \\
 & \overline{x \ y} \leftrightarrow \overline{xy} \quad , \quad \overline{\cdots 1} \leftrightarrow \cdots \longrightarrow , \\
 & \overline{\cdots x} \leftrightarrow \overline{\cdots S(x)} \quad , \quad \overline{\begin{array}{c} x \\ \nearrow \end{array}} \leftrightarrow \sum_{(x)} \overline{\begin{array}{c} x'' \\ \nearrow \\ x' \end{array}} ,
 \end{aligned} \tag{11.4}$$

for all $x, y \in H$ and $k, l \in \mathbb{K}$, where $\Delta(x) = \sum_{(x)} x' \otimes x''$ is written using Sweedler’s notation. Let $\mathcal{R}^{\text{ch}}(X, H)$ be the subspace of $\mathcal{D}^{\text{ch}}(X, H)$ generated by the 4T relations (3.2), and set

$$\mathcal{A}^{\text{ch}}(X, H) = \mathcal{D}^{\text{ch}}(X, H) / \mathcal{R}^{\text{ch}}(X, H).$$

We still let $\mathcal{A}^{\text{ch}}(X, H)$ denote the degree-completion of this space, where the *degree* of an H -colored chord diagram on X is the number of chords.

More generally, let $\mathcal{D}^{\text{Jac}}(X, H)$ be the vector space generated by H -colored Jacobi diagrams on X , modulo the local relations

$$\forall x \in H, \quad \begin{array}{c} \text{---} \bullet \text{---} \\ \diagup \quad \diagdown \\ \text{---} \end{array} \leftrightarrow \sum_{(x)} \begin{array}{c} \text{---} \bullet \text{---} \\ \diagup \quad \diagdown \\ \text{---} \end{array} \quad \text{and (11.4).} \quad (11.5)$$

Let $\mathcal{R}^{\text{Jac}}(X, H)$ be the subspace of $\mathcal{D}^{\text{Jac}}(X, H)$ generated by the STU relations (3.3), and set

$$\mathcal{A}^{\text{Jac}}(X, H) = \mathcal{D}^{\text{Jac}}(X, H) / \mathcal{R}^{\text{Jac}}(X, H).$$

We still let $\mathcal{A}^{\text{Jac}}(X, H)$ denote the degree-completion of this space, where the *degree* of an H -colored Jacobi diagram on X is half the total number of vertices.

Example 11.7. Assume that $H = \mathbb{K}[\pi]$ is the group Hopf algebra of a group π . Then $\mathcal{A}^{\text{ch}}(X, H)$ and $\mathcal{A}^{\text{Jac}}(X, H)$ are canonically isomorphic to the spaces $\mathcal{A}^{\text{ch}}(X, \pi)$ and $\mathcal{A}^{\text{Jac}}(X, \pi)$, respectively, introduced in Section 4.1.

Let $I := \ker(\epsilon: H \rightarrow \mathbb{K})$ be the augmentation ideal of H and, for $k \geq 0$, let $F_k \mathcal{D}^{\text{ch}}(X, H)$ be the subspace of $\mathcal{D}^{\text{ch}}(X, H)$ spanned by H -colored chord diagrams on X with (at least) k beads colored by elements of I . Let $F_k \mathcal{A}^{\text{ch}}(X, H)$ denote the image of $F_k \mathcal{D}^{\text{ch}}(X, H)$ in $\mathcal{A}^{\text{ch}}(X, H)$. Thus we obtain a filtration

$$\mathcal{A}^{\text{ch}}(X, H) = F_0 \mathcal{A}^{\text{ch}}(X, H) \supset F_1 \mathcal{A}^{\text{ch}}(X, H) \supset F_2 \mathcal{A}^{\text{ch}}(X, H) \supset \dots$$

The I -adic completion

$$\widehat{\mathcal{A}}^{\text{ch}}(X, H) := \varprojlim_k \frac{\mathcal{A}^{\text{ch}}(X, H)}{F_k \mathcal{A}^{\text{ch}}(X, H)}$$

of $\mathcal{A}^{\text{ch}}(X, H)$ inherits a filtration from $\mathcal{A}^{\text{ch}}(X, H)$. Let $\alpha: \mathcal{A}^{\text{ch}}(X, H) \rightarrow \widehat{\mathcal{A}}^{\text{ch}}(X, H)$ be the canonical map. Applying the same definitions to Jacobi diagrams yields the space $\widehat{\mathcal{A}}^{\text{Jac}}(X, H)$. According to the next theorem, we can identify the filtered spaces $\mathcal{A}^{\text{ch}}(X, H)$ and $\mathcal{A}^{\text{Jac}}(X, H)$ (resp. $\widehat{\mathcal{A}}^{\text{ch}}(X, H)$ and $\widehat{\mathcal{A}}^{\text{Jac}}(X, H)$) and simply denote them by $\mathcal{A}(X, H)$ (resp. $\widehat{\mathcal{A}}(X, H)$).

Theorem 11.8. *The canonical map*

$$\phi: \mathcal{A}^{\text{ch}}(X, H) \longrightarrow \mathcal{A}^{\text{Jac}}(X, H)$$

is an isomorphism of filtered spaces. Furthermore, the AS and IHX relations (3.4) hold in $\mathcal{A}^{\text{Jac}}(X, H)$.

Proof. Clearly, ϕ is a filtration-preserving linear map, i.e., $\phi(F_k \mathcal{A}^{\text{ch}}(X, H))$ is contained in $F_k \mathcal{A}^{\text{Jac}}(X, H)$ for $k \geq 0$. We can check

$$\phi(F_k \mathcal{A}^{\text{ch}}(X, H)) = F_k \mathcal{A}^{\text{Jac}}(X, H)$$

by using the STU relation, the identity

$$\text{Diagram with bead } x \text{ on a strand} = \sum_{(x)} \text{Diagram with beads } x', x'' \text{ on a strand}$$

in $\mathcal{A}^{\text{Jac}}(X, H)$ for $x \in H$, and the inclusion $\Delta(I) \subset I \otimes \mathbb{K} + \mathbb{K} \otimes I$.

The proofs of the injectivity of ϕ and the AS and IHX relations given in Theorem 4.4 for a group algebra $H = \mathbb{K}[\pi]$ work for a general H . \square

Every homomorphism $f: H \rightarrow H'$ of cocommutative Hopf algebras induces a linear map $f_*: \mathcal{A}(X, H) \rightarrow \mathcal{A}(X, H')$ by applying f to all beads of an H -colored Jacobi diagram on X . Thus we obtain a functor $\mathcal{A}(X, -)$ from cocommutative Hopf algebras to vector spaces, which admits a “continuous” version as follows.

Let $\hat{H} := \varprojlim_k H/I^k$ be the I -adic completion of H , which is a cocommutative complete Hopf algebra. The canonical map $H \rightarrow \hat{H}$ will be omitted from our notations, although it may not be injective. We can express every $\hat{x} \in \hat{H}$ as

$$\hat{x} = \sum_{k=0}^{\infty} x(k) \quad \text{where } x(k) \in I^k.$$

For a set S , we write an S -colored Jacobi diagram D on X as

$$D = D(s_1, \dots, s_r),$$

where s_1, \dots, s_r are the colors of the beads numbered from 1 to r , and $D(-, \dots, -)$ stands for the corresponding Jacobi diagram on X with “uncolored” beads. Thus every \hat{H} -colored Jacobi diagram on X

$$D = D(\hat{x}_1, \dots, \hat{x}_r) \quad \text{where } \hat{x}_1 = \sum_{k_1=0}^{\infty} x_1(k_1), \dots, \hat{x}_r = \sum_{k_r=0}^{\infty} x_r(k_r)$$

defines an element

$$D(\hat{x}_1, \dots, \hat{x}_r) := \sum_{k_1, \dots, k_r=0}^{\infty} \alpha(D(x_1(k_1), \dots, x_r(k_r))) \in \hat{\mathcal{A}}(X, H).$$

We can easily verify the following lemma.

Lemma 11.9. *Every homomorphism $f: \widehat{H} \rightarrow \widehat{H}'$ of complete Hopf algebras, between the I -adic completions of cocommutative Hopf algebras H and H' , induces a unique filtration-preserving linear map $f_*: \widehat{\mathcal{A}}(X, H) \rightarrow \widehat{\mathcal{A}}(X, H')$ such that*

$$f_*\alpha(D(x_1, \dots, x_k)) = D(f(x_1), \dots, f(x_k)) \quad (11.6)$$

for every H -colored Jacobi diagram $D(x_1, \dots, x_k)$ on X . Moreover, we have $(f'f)_* = f'_*f_*$ for all such homomorphisms $\widehat{H} \xrightarrow{f} \widehat{H}' \xrightarrow{f'} \widehat{H}''$.

11.5. A Hopf-algebraic description of the kernel of κ . In this subsection, we fix $m, n \geq 1$ and set

$$F_m = F(x_1, \dots, x_m), \quad X_n = \curvearrowleft_1 \cdots \curvearrowleft_n.$$

Recall that the degree-completion of $\mathcal{A}(X_n, \mathbb{K}[F_m])$ is denoted by the same notation $\mathcal{A}(X_n, \mathbb{K}[F_m])$, and the I -adic completion of $\mathcal{A}(X_n, \mathbb{K}[F_m])$ is denoted by $\widehat{\mathcal{A}}(X_n, \mathbb{K}[F_m])$. We have seen in Section 11.4 that the canonical homomorphism $\mathbb{K}[F_m] \rightarrow \widehat{\mathbb{K}[F_m]}$, where $\widehat{\mathbb{K}[F_m]}$ is the I -adic completion of $\mathbb{K}[F_m]$, has a diagrammatic counterpart $\alpha: \mathcal{A}(X_n, \mathbb{K}[F_m]) \rightarrow \widehat{\mathcal{A}}(X_n, \mathbb{K}[F_m])$. Theorem 11.6 and Proposition 11.10 below imply that α is not injective, in contrast with the well-known injectivity of $\mathbb{K}[F_m] \rightarrow \widehat{\mathbb{K}[F_m]}$.

Proposition 11.10. *There is a canonical isomorphism between ${}^s\mathcal{A}(m, n)$ and $\widehat{\mathcal{A}}(X_n, \mathbb{K}[F_m])$ which makes the following diagram commute:*

$$\begin{array}{ccc} \widehat{\mathbf{A}}(m, n) & \xrightarrow{\kappa} & {}^s\mathcal{A}(m, n) \\ \parallel & & \downarrow \cong \\ \mathcal{A}(X_n, \mathbb{K}[F_m]) & \xrightarrow{\alpha} & \widehat{\mathcal{A}}(X_n, \mathbb{K}[F_m]) \end{array}$$

In particular, the kernel of κ coincides with the kernel of α .

Proof. Set $U_m = \{1^+, \dots, m^+\}$. We can merge the notions of “ U_m -labeled Jacobi diagram” and “Jacobi diagram on X_n ” into the notion of “ U_m -labeled Jacobi diagram on X_n ”; the degree of such a diagram is half the total number of vertices. (Here we assume that each connected component of a U_m -labeled Jacobi diagram on X_n has at least one univalent vertex on X_n .) Let $\mathcal{A}(X_n, U_m)$ be the (degree-completion of the) vector space generated by U_m -labeled Jacobi diagrams on X_n modulo the STU relation.

Let $\chi: {}^s\mathcal{A}(m, n) \rightarrow \mathcal{A}(X_n, U_m)$ be the diagrammatic analog of the PBW isomorphism. We will prove that the maps α and κ fit into the following commutative

diagram:

$$\begin{array}{ccccc}
 \widehat{\mathcal{A}}(m, n) & \xrightarrow{\kappa} & {}^s\mathcal{A}(m, n) & \xrightarrow[\cong]{\chi} & \mathcal{A}(X_n, U_m) \\
 \parallel & & & & \uparrow \hat{\lambda} \\
 \mathcal{A}(X_n, \mathbb{K}[F_m]) & \xrightarrow{\alpha} & \widehat{\mathcal{A}}(X_n, \mathbb{K}[F_m]) & \xrightarrow[\cong]{f_*} & \widehat{\mathcal{A}}(X_n, T(V_m))
 \end{array} \tag{11.7}$$

Here $T(V_m)$ is the tensor algebra over the vector space V_m with basis $\{v_1, \dots, v_m\}$, equipped with the usual Hopf algebra structure. Using Lemma 11.9, the isomorphism f_* is induced by the complete Hopf algebra isomorphism $f: \widehat{\mathbb{K}[F_m]} \rightarrow \widehat{T(V_m)}$ that maps each x_i to $\exp(v_i)$. The map $\hat{\lambda}$ is induced by a filtration-preserving linear map $\lambda: \mathcal{A}(X_n, T(V_m)) \rightarrow \mathcal{A}(X_n, U_m)$ defined below.

We can transform every $T(V_m)$ -colored Jacobi diagram D on X_n into a U_m -labeled Jacobi diagram on X_n by applying the following transformations to beads:

$$\begin{array}{ccc}
 \begin{array}{c} v_{i_1} v_{i_2} \cdots v_{i_r} \\ \bullet \\ \longrightarrow \end{array} & \rightsquigarrow & \begin{array}{c} i_1^+ i_2^+ \quad i_r^+ \\ \vdots \quad \vdots \quad \vdots \\ \longrightarrow \end{array} \\
 \forall i_1, \dots, i_r \in \{1, \dots, m\}, & & \\
 \begin{array}{c} \cdots v_{i_1} v_{i_2} \cdots v_{i_r} \\ \bullet \\ \dashrightarrow \end{array} & \rightsquigarrow & \begin{array}{c} i_1^+ i_2^+ \quad i_r^+ \\ \vdots \quad \vdots \quad \vdots \\ \dashrightarrow \end{array}
 \end{array}$$

By the STU (and AS, IHX) relations in $\mathcal{A}(X_n, U_m)$, the above procedure defines a linear map $\mathcal{D}^{\text{Jac}}(X_n, T(V_m)) \rightarrow \mathcal{A}(X_n, U_m)$, which induces a linear map

$$\lambda: \mathcal{A}(X_n, T(V_m)) \longrightarrow \mathcal{A}(X_n, U_m).$$

Obviously, λ is filtration-preserving. One easily checks from the definitions that the resulting map $\hat{\lambda}$ makes the diagram (11.7) commute.

To prove the proposition, it suffices to show that $\hat{\lambda}$ is an isomorphism. For this, we will construct an inverse to $\hat{\lambda}$. Let D be a U_m -labeled Jacobi diagram on X_n . We can decompose D uniquely as

$$D = D_0 \cup D'_1 \cup \cdots \cup D'_r,$$

where D_0 is a Jacobi diagram on X_n , we have r distinguished points $*_1, \dots, *_r$ in the interiors of the edges of $X_n \cup D_0$, each D'_i is a $(U_m \cup \{*_i\})$ -labeled tree-shaped Jacobi diagram with exactly one univalent vertex labeled by $*_i$, and we have $D'_i \cap D'_j = \emptyset$ for all $i \neq j$ and $D'_i \cap D_0 = \{*_i\}$ for all i . Note that each tree D'_i , rooted at $*_i$, defines a Lie word with letters in U_m : hence, using the correspondence $i^+ \leftrightarrow v_i$ between U_m and the basis of V_m , each D'_i defines a primitive element $d'_i \in T(V_m)$. Choose an orientation on each edge of D_0 . For each $i \in \{1, \dots, r\}$, set $\varepsilon_i = 0$ if $*_i$ belongs to X_n or if $*_i$ belongs to an edge of D_0 and the tree D'_i is

above this edge when its orientation goes from left to right; set $\varepsilon_i = 1$ otherwise. Let S denote the antipode of $T(V_m)$. By considering the $T(V_m)$ -colored Jacobi diagram on X_n that is obtained from D_0 by putting a bead colored by $S^{\varepsilon_i}(d'_i)$ at $*_i$ for all $i \in \{1, \dots, r\}$, we obtain an element

$$\rho(D) \in \mathcal{D}^{\text{Jac}}(X_n, T(V_m))$$

which does not depend on the above choice of edge-orientations. It is easy to verify that an STU relation in $\mathcal{A}(X_n, U_m)$ is mapped by ρ either to 0 or to an STU relation in $\mathcal{D}^{\text{Jac}}(X_n, T(V_m))$. Hence we obtain a linear map

$$\rho: \mathcal{A}(X_n, U_m) \longrightarrow \mathcal{A}(X_n, T(V_m)),$$

with $\mathcal{A}(X_n, U_m)$ before completion, inducing a linear map

$$\hat{\rho}: \mathcal{A}(X_n, U_m) \longrightarrow \hat{\mathcal{A}}(X_n, T(V_m)),$$

with $\mathcal{A}(X_n, U_m)$ after degree-completion. Obviously, we have $\hat{\rho} \circ \hat{\lambda} = \text{id}$. Using the STU (and AS, IHX) relations in $\mathcal{A}(X_n, U_m)$, it is easy to check $\hat{\lambda} \circ \hat{\rho} = \text{id}$. \square

12. Perspectives

We plan to consider several developments of the functor $Z = Z^{\mathcal{B}}: \mathcal{B}_q \rightarrow \hat{\mathbf{A}}$ in forthcoming works. For simplicity, the degree-completion $\hat{\mathbf{A}}$ of \mathbf{A} will now be denoted as \mathbf{A} . Also, we will ignore parenthesization of objects in non-strict monoidal categories and write \mathcal{B} for \mathcal{B}_q , for instance.

12.1. Incorporation of tangles. One can naturally construct a braided strict monoidal category \mathcal{BT} which contains both the categories \mathcal{B} and \mathcal{T} as braided monoidal subcategories. The objects of \mathcal{BT} are words in the letters $+, -, \bullet$ and morphisms are bottom tangles in handlebodies mixed with additional tangles. Similarly, there is \mathcal{LCobT} containing both \mathcal{LCob} and \mathcal{T} as braided monoidal subcategories. We can extend the functors $Z: \mathcal{B} \rightarrow \mathbf{A}$ and $\tilde{Z}: \mathcal{LCob} \rightarrow {}^{\text{ts}}\mathcal{A}$ to \mathcal{BT} and \mathcal{LCobT} , respectively, so that the commutative square (1.9) extends to

$$\begin{array}{ccc} \mathcal{BT} & \xrightarrow{Z} & \mathbf{A}^\dagger \\ E \downarrow & & \downarrow \kappa \\ \mathcal{LCobT} & \xrightarrow{\tilde{Z}} & {}^{\text{ts}}\mathcal{A}^\dagger \end{array} \quad (12.1)$$

Here \mathbf{A}^\dagger is a linear symmetric monoidal category extending both \mathbf{A} and the linear version of \mathcal{A} mentioned in Remark 3.5, and, similarly, ${}^{\text{ts}}\mathcal{A}^\dagger$ extends both ${}^{\text{ts}}\mathcal{A}$ and this

linear version of \mathcal{A} . We remark that the extension of \tilde{Z} to $\mathcal{LCob}\mathcal{T}$ also generalizes Nozaki’s extension of the LMO functor to Lagrangian cobordisms of punctured surfaces [52].

As a symmetric monoidal linear category, \mathbf{A}^\dagger is free on a triple (H, V, V^*) consisting of a Casimir Hopf algebra H , a left H -module V and its dual V^* . The functor Z induces an isomorphism of graded linear symmetric monoidal categories between the associated graded of the Vassiliev–Goussarov filtration for \mathcal{BT} and \mathbf{A}^\dagger .

Let $m \geq 0$ be an integer and recall that $S \subset \partial V_m$ is the bottom square. Consider the compact oriented surface $\Sigma_{m,1} := \partial V_m \setminus \text{int}(S)$ of genus m with one boundary component. The morphisms in \mathcal{BT} whose underlying bottom tangle in a handlebody is $\text{id}_m \in \mathcal{B}(m, m)$ can be regarded as tangles in the thickened surface $\Sigma_{m,1} \times I$. In particular, by specializing the above functor $Z: \mathcal{BT} \rightarrow \mathbf{A}^\dagger$ to that kind of morphisms, we obtain

- expansions of the free group $\pi_1(\Sigma_{m,1})$, which refine the symplectic expansions derived from the LMO functor [49],
- representations of pure braid groups on $\Sigma_{m,1}$, and, more generally, representations of monoids of string-links in $\Sigma_{m,1} \times I$.

We plan to study elsewhere these new representations.

12.2. Handlebody groups and twist groups. Fix an integer $m \geq 0$. The automorphism group of the object m in $\mathcal{H} \cong \mathcal{B}^{\text{op}}$ is naturally identified with the *handlebody group*

$$\mathcal{H}_{m,1} := \text{Homeo}(V_m, S) / \cong,$$

which is the group of isotopy classes rel S of self-homeomorphisms of V_m that restrict to id_S . Hence the functor $Z: \mathcal{B} \rightarrow \mathbf{A}$ restricts to a monoid homomorphism

$$Z: \mathcal{H}_{m,1} \longrightarrow A_m := \mathbf{A}(m, m)^{\text{op}}. \tag{12.2}$$

It is well known that the group $\mathcal{H}_{m,1}$ naturally embeds into the *mapping class group*

$$\mathcal{M}_{m,1} := \text{Homeo}(\Sigma_{m,1}, \partial \Sigma_{m,1}) / \cong$$

of the surface $\Sigma_{m,1} = \partial V_m \setminus \text{int}(S)$. Since the LMO functor \tilde{Z} is injective² on the Lagrangian subgroup of $\mathcal{M}_{m,1}$ (i.e., the automorphism group of the object m in \mathcal{LCob}), Theorem 1.5 implies that $Z: \mathcal{H}_{m,1} \rightarrow A_m$ is injective. We plan to use this

² This follows easily from the injectivity of \tilde{Z} on the Torelli group [9, Corollary 8.22] since the strut part of \tilde{Z} encodes the action of the Lagrangian subgroup of $\mathcal{M}_{m,1}$ on $H_1(\Sigma_{m,1}; \mathbb{Z})$.

homomorphism to study the algebraic structure of $\mathcal{H}_{m,1}$ and the inclusion of this group in the monoid $\mathcal{H}(m, m)$.

In particular, we are interested in the *twist group* $\mathcal{T}_{m,1}$ which is the kernel of the natural homomorphism $\mathcal{H}_{m,1} \rightarrow \text{Aut}(F_m)$. Here $F_m := \pi_1(V_m, S)$ is the fundamental group of V_m based at the contractible subspace S . Note that $\mathcal{T}_{m,1}$ is the kernel of the degree 0 part of $Z: \mathcal{H}_{m,1} \rightarrow A_m$, since the latter gives the homotopy class of bottom tangles in handlebodies. It is known that, as a subgroup of $\mathcal{M}_{m,1}$, the group $\mathcal{T}_{m,1}$ is generated by Dehn twists along boundaries of properly embedded disks in $V_m \setminus S$ [44].

The pair (handlebody group, twist group) can be regarded as an analogue of the pair (mapping class group, Torelli group). We recall some of the features of the Johnson–Morita theory, which consists in studying the group $\mathcal{M}_{m,1}$ via its action on the lower central series of the fundamental group π of $\Sigma_{m,1}$ (see [50] for a survey):

- (1) the *Johnson filtration* $J_0\mathcal{M}_{m,1} \supset J_1\mathcal{M}_{m,1} \supset \cdots \supset J_k\mathcal{M}_{m,1} \supset \cdots$ consists of the kernels of the actions of $\mathcal{M}_{m,1}$ on the successive nilpotent quotients of π (so that $J_0\mathcal{M}_{m,1} = \mathcal{M}_{m,1}$ and $J_1\mathcal{M}_{m,1}$ is the Torelli group);
- (2) for every $k \geq 1$, the k -th *Johnson homomorphism* τ_k maps $J_k\mathcal{M}_{m,1}$ to an abelian group and encodes the action of $J_k\mathcal{M}_{m,1}$ on the k -th nilpotent quotient of π ;
- (3) for every $k \geq 1$, the k -th Johnson homomorphism has a diagrammatic description and then corresponds to the leading term of the “tree reduction” of the LMO functor \tilde{Z} on $J_k\mathcal{M}_{m,1}$ [9, 26];
- (4) more generally, the action of $J_1\mathcal{M}_{m,1}$ on (the Malcev completion of) π is encoded in the full “tree reduction” of the LMO functor \tilde{Z} by means of a “symplectic expansion” [49].

There is an analogue of the Johnson–Morita theory for the pair (handlebody group, twist group). This has been introduced in [27, §10.1] as an instance of a “general theory” of Johnson homomorphisms, and will be studied with further details in a forthcoming work. In this approach, the group $\mathcal{H}_{m,1}$ is studied via its action on the lower central series of the kernel of the homomorphism $\pi \rightarrow F_m$ induced by the inclusion $\Sigma_{m,1} \hookrightarrow V_m$. Then the analogue of (1) is a filtration of $\mathcal{H}_{m,1}$ whose first term is $\mathcal{T}_{m,1}$, and the analogue of (2) consists of two sequences of homomorphisms $(\tau_k^0)_k$ and $(\tau_k^1)_k$ which happen to be equivalent one to the other. There are also analogues of (3) and (4), which involve the “tree reduction” of $Z: \mathcal{H}_{m,1} \rightarrow A_m$ and the refinement of the “symplectic expansion” mentioned in Section 12.1.

We expect the homomorphism $Z: \mathcal{H}_{m,1} \rightarrow A_m$ to be a powerful tool to study the associated graded of the lower central series of $\mathcal{T}_{m,1}$ in relation with the associated graded of the Vassiliev–Goussarov filtration that has been identified in Section 10.4.

12.3. Extension of Z to boundary Lagrangian cobordisms. The reader may wonder whether one can extend the functor $Z: {}^s\mathcal{L}Cob \rightarrow \mathbf{A}$ on ${}^s\mathcal{L}Cob \cong \mathcal{B}$ to the category $\mathcal{L}Cob$ of Lagrangian cobordisms, with the target category still involving some homotopy classes of Jacobi diagrams in handlebodies. This does not hold, but one can extend Z to a functor ${}^bZ: {}^b\mathcal{L}Cob \rightarrow {}^b\mathbf{A}$ which fits into the following commutative diagram of monoidal categories and monoidal functors:

$$\begin{array}{ccc}
 {}^s\mathcal{L}Cob & \xrightarrow{Z} & \mathbf{A} \\
 \downarrow & & \downarrow \\
 {}^b\mathcal{L}Cob & \xrightarrow{{}^bZ} & {}^b\mathbf{A} \\
 \downarrow & & \downarrow \kappa' \\
 \mathcal{L}Cob & \xrightarrow{\tilde{Z}} & {}^{\text{ts}}\mathbf{A}
 \end{array}$$

The category ${}^b\mathcal{L}Cob$ of *boundary Lagrangian cobordisms*, defined below, is a braided monoidal subcategory of $\mathcal{L}Cob$ which contains ${}^s\mathcal{L}Cob$ as a braided monoidal subcategory. The vertical arrows on the left are inclusion functors. Like ${}^s\mathcal{L}Cob$ and $\mathcal{L}Cob$, the objects of ${}^b\mathcal{L}Cob$ are non-negative integers. The morphisms from m to n in ${}^b\mathcal{L}Cob$ are cobordisms $C = (C, c): m \rightarrow n$, in the sense of Section 2.4, such that the composite $\underline{C} := V_n \circ C: m \rightarrow 0$ is a homology handlebody where the m meridian curves in $\partial \underline{C} \cong \partial V_m$ bound mutually disjoint, connected, oriented surfaces S_1, \dots, S_m . This notion may be thought of as a cobordism version of boundary links. Note that ${}^b\mathcal{L}Cob(0, 0) = \mathcal{L}Cob(0, 0)$ is essentially the monoid of homology 3-spheres (whereas ${}^s\mathcal{L}Cob(0, 0)$ is trivial).

The target category ${}^b\mathbf{A}$ of bZ is much larger than \mathbf{A} : there, Jacobi diagrams in handlebodies may involve connected components with no univalent vertex. Note that ${}^b\mathbf{A}(0, 0)$ is the target of the LMO invariant of homology 3-spheres (whereas $\mathbf{A}(0, 0)$ is 1-dimensional). The category ${}^b\mathbf{A}$ includes \mathbf{A} as a symmetric monoidal linear subcategory, and the functor $\kappa': {}^b\mathbf{A} \rightarrow {}^{\text{ts}}\mathbf{A}$ is a natural extension of the hair map $\kappa: \mathbf{A} \rightarrow {}^{\text{ts}}\mathbf{A}$.

We plan to construct the functor bZ as follows. Every boundary Lagrangian cobordism $C: m \rightarrow n$ is obtained from a special Lagrangian cobordism $C': m \rightarrow n$ by surgery along a framed link L in C' such that

- each component of L is null-homotopic in $V_n \circ C' = V_m$,

- the linking matrix of L is diagonal with diagonal entries ± 1 , where linking numbers and framings of components of L are defined in $V_n \circ C' = V_m$.

The Kontsevich integral $Z(C' \cup L) \in \mathbf{A}^\dagger(m, n)$ is as outlined in Section 12.1. Then the invariant ${}^bZ(C)$ is obtained from $Z(C' \cup L)$ by applying an equivariant version of the Aarhus integral developed by Garoufalidis and Kricker [16] to each component of the surgery link L .

We hope that bZ will be useful to study the LMO invariant of homology 3-spheres in relation with their fundamental groups. Indeed, it seems difficult to conduct such a study using the LMO functor \tilde{Z} instead of bZ .

References

- [1] J. E. Andersen, A. J. Bene, J.-B. Meilhan and R. C. Penner, Finite type invariants and fatgraphs. *Adv. Math.* **225** (2010), no. 4, 2117–2161. [MR 2680201](#) [Zbl 1222.57007](#)
- [2] D. Altschüler and A. Coste, Quasi-quantum groups, knots, three-manifolds, and topological field theory. *Comm. Math. Phys.* **150** (1992), no. 1, 83–107. [MR 1188498](#) [Zbl 0773.57004](#)
- [3] J. E. Andersen, J. Mattes, and N. Reshetikhin, Quantization of the algebra of chord diagrams. *Math. Proc. Cambridge Philos. Soc.* **124** (1998), no. 3, 451–467. [MR 1636568](#) [Zbl 0943.57007](#)
- [4] D. Bar-Natan, On the Vassiliev knot invariants. *Topology* **34** (1995), no. 2, 423–472. [MR 1318886](#) [Zbl 0898.57001](#)
- [5] D. Bar-Natan, Vassiliev and quantum invariants of braids. In L. H. Kauffman (ed.), *The interface of knots and physics*. Lecture notes prepared for the American Mathematical Society Short Course on Knots and Physics held in San Francisco, California, January 2–3, 1995. Proceedings of Symposia in Applied Mathematics, 51. AMS Short Course Lecture Notes. American Mathematical Society, Providence, R.I., 1996, 129–144. [MR 1372767](#) [Zbl 0841.57007](#)
- [6] D. Bar-Natan, Non-associative tangles. In W. H. Kazez (ed.), *Geometric topology*. Proceedings of the 1993 Georgia International Topology Conference held at the University of Georgia, Athens, GA, August 2–13, 1993. AMS/IP Studies in Advanced Mathematics, 2.1. American Mathematical Society, Providence, R.I., and International Press, Cambridge, MA, 1997, 139–183. [MR 1470726](#) [Zbl 0888.57008](#)
- [7] D. Bar-Natan, S. Garoufalidis, L. Rozansky, and D. P. Thurston, The Aarhus integral of rational homology 3-spheres. II. Invariance and universality. *Selecta Math. (N.S.)* **8** (2002), no. 3, 341–371. [MR 1931168](#) [Zbl 1012.57016](#)
- [8] P. Cartier, Construction combinatoire des invariants de Vassiliev–Kontsevich des nœuds. *C. R. Acad. Sci. Paris Sér. I Math.* **316** (1993), no. 11, 1205–1210. [MR 1221650](#) [Zbl 0791.57006](#)

- [9] D. Cheptea, K. Habiro, and G. Massuyeau, A functorial LMO invariant for Lagrangian cobordisms. *Geom. Topol.* **12** (2008), no. 2, 1091–1170.
[MR 2403806](#) [Zbl 1148.57017](#)
- [10] D. Cheptea and T. T. Q. Le, A TQFT associated to the LMO invariant of three-dimensional manifolds. *Comm. Math. Phys.* **272** (2007), no. 3, 601–634.
[MR 2304469](#) [Zbl 1145.81049](#)
- [11] L. Crane and D. Yetter, On algebraic structures implicit in topological quantum field theories. *J. Knot Theory Ramifications* **8** (1999), no. 2, 125–163. [MR 1687553](#)
[Zbl 0935.57025](#)
- [12] V. G. Drinfel'd, *Quantum groups*, In A. M. Gleason (ed.), *Proceedings of the International Congress of Mathematicians*. Vol. 1. Held at the University of California, Berkeley, California, August 3–11, 1986. American Mathematical Society, Providence, R.I., 1987, 798–820. [MR 0934283](#) [Zbl 0667.16003](#)
- [13] V. G. Drinfel'd, Quasi-Hopf algebras. *Algebra i Analiz* **1** (1989), no. 6, 114–148. In Russian. English translation, *Leningrad Math. J.* **1** (1990), no. 6, 1419–1457.
[MR 1047964](#) [Zbl 0718.16033](#)
- [14] V. G. Drinfel'd, On quasitriangular quasi-Hopf algebras and on a group that is closely connected with $\text{Gal}(\bar{\mathbf{Q}}/\mathbf{Q})$. *Algebra i Analiz* **2** (1990), no. 4, 149–181. In Russian. English translation, *Leningrad Math. J.* **2** (1991), no. 4, 829–860. [MR 1080203](#)
[Zbl 0728.16021](#)
- [15] H. Furusho, Pentagon and hexagon equations. *Ann. of Math. (2)* **171** (2010), no. 1, 545–556. [MR 2630048](#) [Zbl 1257.17019](#)
- [16] S. Garoufalidis and A. Kricker, A rational noncommutative invariant of boundary links. *Geom. Topol.* **8** (2004), 115–204. [MR 2033481](#) [Zbl 1075.57004](#)
- [17] S. Garoufalidis and J. Levine, Homology surgery and invariants of 3-manifolds. *Geom. Topol.* **5** (2001), 551–578. [MR 1833753](#) [Zbl 1009.57022](#)
- [18] S. Garoufalidis and L. Rozansky, The loop expansion of the Kontsevich integral, the null-move and Sequivallence. *Topology* **43** (2004), no. 5, 1183–1210. [MR 2080000](#)
[Zbl 1052.57011](#)
- [19] M. N. Gusarov, A new form of the Conway–Jones polynomial of oriented links. *Zap. Nauchn. Sem. Leningrad. Otdel. Mat. Inst. Steklov. (LOMI)* **193** (1991), *Geom. i Topol.* 1, 4–9, 161. In Russian. English translation in O. Viro (ed.), *Topology of manifolds and varieties*. Advances in Soviet Mathematics, 18. American Mathematical Society, Providence, R.I., 1994, 167–172. [MR 1157140](#) [MR 1296894](#)
(transl.) [Zbl 0816.57006](#)
- [20] N. Habegger and G. Masbaum, The Kontsevich integral and Milnor's invariants. *Topology* **39** (2000), no. 6, 1253–1289. [MR 1783857](#) [Zbl 0964.57011](#)
- [21] K. Habiro, Claspers and finite type invariants of links. *Geom. Topol.* **4** (2000), 1–83.
[MR 1735632](#) [Zbl 0941.57015](#)

- [22] K. Habiro, Bottom tangles and universal invariants. *Algebr. Geom. Topol.* **6** (2006), 1113–1214. [MR 2253443](#) [Zbl 1130.57014](#)
- [23] K. Habiro, A note on quantum fundamental groups and quantum representation varieties for 3-manifolds. *Surikaiseikikenkyusho Kokyuroku* **1777** (2012), 21–30.
- [24] K. Habiro, *On the category of finitely generated free groups*. Preprint, 2016. [arXiv:1609.06599](#)
- [25] K. Habiro, Category of bottom tangles. In preparation.
- [26] K. Habiro and G. Massuyeau, Symplectic Jacobi diagrams and the Lie algebra of homology cylinders. *J. Topol.* **2** (2009), no. 3, 527–569. [MR 2546585](#) [Zbl 1202.57014](#)
- [27] K. Habiro and G. Massuyeau, Generalized Johnson homomorphisms for extended N -series. *J. Algebra* **510** (2018), 205–258. [MR 3828784](#) [Zbl 1411.57035](#)
- [28] M. Hennings, Invariants of links and 3-manifolds obtained from Hopf algebras. *J. London Math. Soc. (2)* **54** (1996), no. 3, 594–624. [MR 1413901](#) [Zbl 0882.57002](#)
- [29] V. Hinich and A. Vaintrob, Cyclic operads and algebra of chord diagrams. *Selecta Math. (N.S.)* **8** (2002), no. 2, 237–282. [MR 1913297](#) [Zbl 0999.18008](#)
- [30] C. Kassel, *Quantum groups*. Graduate Texts in Mathematics, 155. Springer-Verlag, New York, 1995. [MR 1321145](#) [Zbl 0808.17003](#)
- [31] C. Kassel and V. Turaev, Chord diagram invariants of tangles and graphs. *Duke Math. J.* **92** (1998), no. 3, 497–552. [MR 1620522](#) [Zbl 0947.57010](#)
- [32] L. H. Kauffman, Gauss codes, quantum groups and ribbon Hopf algebras. *Rev. Math. Phys.* **5** (1993), no. 4, 735–773. [MR 1253734](#) [Zbl 0803.57001](#)
- [33] G. M. Kelly, *Basic concepts of enriched category theory*. London Mathematical Society Lecture Note Series, 64. Cambridge University Press, Cambridge and New York, 1982. [MR 0651714](#) [Zbl 0478.18005](#)
- [34] T. Kerler, Genealogy of non-perturbative quantum-invariants of 3-manifolds: the surgical family. In J. E. Andersen, J. Dupont, H. Pedersen, and A. Swann (eds.), *Geometry and physics*. Papers from the Special Session held at the University of Aarhus, Aarhus, 1995. Lecture Notes in Pure and Applied Mathematics, 184. Marcel Dekker, New York, 1997, 503–547. [MR 1423190](#) [Zbl 0869.57014](#)
- [35] T. Kerler, Towards an algebraic characterization of 3-dimensional cobordisms. In D. E. Radford, F. J. O. Souza and D. N. Yetter (eds.), *Diagrammatic morphisms and applications*. Papers from the AMS Special Session on Diagrammatic Morphisms in Algebra, Category Theory, and Topology. Held at San Francisco State University, San Francisco, CA, October 21–22, 2000. Contemporary Mathematics, 318. American Mathematical Society, Providence, R.I., 2003, 141–173. [MR 1973515](#) [Zbl 1168.57313](#)

- [36] J. Klim, Transmutation and bosonisation of quasi-Hopf algebras. Preprint, 2009. [arXiv:0903.3959](#)
- [37] M. Kontsevich, Feynman diagrams and low-dimensional topology. In A. Joseph, F. Mignot, F. Murat, B. Prum, and R. Rentschler (eds.), *First European Congress of Mathematics*. Vol. II. Invited lectures. Part 2. Proceedings of the congress held at the Sorbonne and Panthéon–Sorbonne Universities, Paris, July 6–10, 1992. Progress in Mathematics, 120. Birkhäuser Verlag, Basel, 1994, 97–121. [MR 1341841](#) [Zbl 0872.57001](#)
- [38] R. J. Lawrence, A universal link invariant using quantum groups. In A. I. Solomon (ed.), *Differential geometric methods in theoretical physics*. Proceedings of the Seventeenth International Conference held in Chester, August 15–19, 1988. World Scientific Publishing Co., Teaneck, N.J., 1989, 55–63. [MR 1124415](#) [Zbl](#)
- [39] T. Q. T. Le and J. Murakami, The universal Vassiliev–Kontsevich invariant for framed oriented links. *Compositio Math.* **102** (1996), no. 1, 41–64. [MR 1394520](#) [Zbl 0851.57007](#)
- [40] T. T. Q. Le and J. Murakami, Parallel version of the universal Vassiliev–Kontsevich invariant. *J. Pure Appl. Algebra* **121** (1997), no. 3, 271–291. [MR 1477611](#) [Zbl 0882.57005](#)
- [41] T. T. Q. Le, J. Murakami, and T. Ohtsuki, On a universal perturbative invariant of 3-manifolds. *Topology* **37** (1998), no. 3, 539–574. [MR 1604883](#) [Zbl 0897.57017](#)
- [42] J. Lieberum, Universal Vassiliev invariants of links in coverings of 3-manifolds. *J. Knot Theory Ramifications* **13** (2004), no. 4, 515–555. [MR 2069038](#) [Zbl 1079.57010](#)
- [43] W. Lowen, Hochschild cohomology of presheaves as map-graded categories. *Int. Math. Res. Not. IMRN* **2008**, Art. ID rnn118, 32 pp. [MR 2449052](#) [Zbl 1160.13010](#)
- [44] E. Luft, Actions of the homeotopy group of an orientable 3-dimensional handlebody. *Math. Ann.* **234** (1978), no. 3, 279–292. [MR 0500977](#) [Zbl 0364.57011](#)
- [45] S. Mac Lane, Categorical algebra. *Bull. Amer. Math. Soc.* **71** (1965), 40–106. [MR 0171826](#) [Zbl 0161.01601](#)
- [46] S. Majid, Algebras and Hopf algebras in braided categories. In J. Bergen and S. Montgomery (eds), *Advances in Hopf algebras*. Papers from the NSF-CBMS Conference on Hopf Algebras and their Actions on Rings held at DePaul University, Chicago, IL, August 10–14, 1992. Lecture Notes in Pure and Applied Mathematics, 158. Marcel Dekker, New York, 1994, 55–105. [MR 1289422](#) [Zbl 0812.18004](#)
- [47] S. Majid, *Foundations of quantum group theory*. Cambridge University Press, Cambridge, 1995. [MR 1381692](#) [Zbl 0857.17009](#)
- [48] M. Markl, Cotangent cohomology of a category and deformations. *J. Pure Appl. Algebra* **113** (1996), no. 2, 195–218. [MR 1415558](#) [Zbl 0865.18011](#)
- [49] G. Massuyeau, Infinitesimal Morita homomorphisms and the tree-level of the LMO invariant. *Bull. Soc. Math. France* **140** (2012), no. 1, 101–161. [MR 2903772](#) [Zbl 1248.57009](#)

- [50] S. Morita, *Structure of the mapping class groups of surfaces: a survey and a prospect*. In J. Hass and M. Scharlemann (eds.), *Proceedings of the Kirbyfest*. Held in Berkeley, CA, June 22–26, 1998. Geometry & Topology Monographs, 2. Geometry & Topology Publications, Coventry, 1999, 349–406. [MR 1734418](#) [Zbl 0959.57018](#)
- [51] J. Murakami and T. Ohtsuki, Topological quantum field theory for the universal quantum invariant. *Comm. Math. Phys.* **188** (1997), no. 3, 501–520. [MR 1473309](#) [Zbl 0938.57022](#)
- [52] Y. Nozaki, An extension of the LMO functor. *Geom. Dedicata* **185** (2016), 271–306. [MR 3570310](#) [Zbl 1364.57015](#)
- [53] T. Ohtsuki, Colored ribbon Hopf algebras and universal invariants of framed links. *J. Knot Theory Ramifications* **2** (1993), no. 2, 211–232. [MR 1227011](#) [Zbl 0798.57006](#)
- [54] T. Ohtsuki, *Quantum invariants. A study of knots, 3-manifolds, and their sets*. Series on Knots and Everything, 29. World Scientific Publishing Co., River Edge, N.J., 2002. [MR 1881401](#) [Zbl 0991.57001](#)
- [55] B. Patureau-Mirand, Noninjectivity of the “hair” map. *Algebr. Geom. Topol.* **12** (2012), no. 1, 415–420. [MR 2916280](#) [Zbl 1243.57008](#)
- [56] T. Pirashvili, On the PROP corresponding to bialgebras. *Cah. Topol. Géom. Différ. Catég.* **43** (2002), no. 3, 221–239. [MR 1928233](#) [Zbl 1057.18005](#)
- [57] S. Piunikhin, Combinatorial expression for universal Vassiliev link invariant. *Comm. Math. Phys.* **168** (1995), no. 1, 1–22. [MR 1324388](#) [Zbl 0828.57007](#)
- [58] N. Yu. Reshetikhin, Quasitriangular Hopf algebras and invariants of tangles. *Algebra i Analiz* **1** (1989), no. 2, 169–188. In Russian. English translation, *Leningrad Math. J.* **1** (1990), no. 2, 491–513. [MR 1025161](#) [Zbl 0715.17016](#)
- [59] N. Yu. Reshetikhin and V. G. Turaev, Ribbon graphs and their invariants derived from quantum groups. *Comm. Math. Phys.* **127** (1990), no. 1, 1–26. [MR 1036112](#) [Zbl 0768.57003](#)
- [60] Y. Sommerhäuser, On the notion of a ribbon quasi-Hopf algebra. *Rev. Un. Mat. Argentina* **51** (2010), no. 1, 177–192. [MR 2681263](#) [Zbl 1218.16021](#)
- [61] D. Tamaki, The Grothendieck construction and gradings for enriched categories. Preprint, 2009. [arXiv:0907.0061](#)
- [62] V. A. Vassiliev, *Cohomology of knot spaces*. In V. I. Arnol’d (ed.), *Theory of singularities and its applications*. Advances in Soviet Mathematics, 1. American Mathematical Society, Providence, R.I., 1990, 23–69. Translated from the Russian. [MR 1089670](#) [Zbl 0727.57008](#)
- [63] P. Vogel, Algebraic structures on modules of diagrams. *J. Pure Appl. Algebra* **215** (2011), no. 6, 1292–1339. [MR 2769234](#) [Zbl 1221.57015](#)

Received November 3, 2019

Kazuo Habiro, Department of Mathematics, Kyoto University, Kyoto 606-8502, Japan
Research Institute for Mathematical Sciences, Kyoto University, Kyoto 606-8502, Japan
e-mail: habiro@math.kyoto-u.ac.jp

Gwénaél Massuyeau, Institut de Mathématiques de Bourgogne, UMR 5584, CNRS,
Université Bourgogne Franche-Comté, 21000 Dijon, France

Institut de Recherche Mathématique Avancée, UMR 7501, CNRS, Université de
Strasbourg, 67084 Strasbourg, France

e-mail: gwenael.massuyeau@u-bourgogne.fr