



# EMS Magazine

Paolo Bellingeri

Women mathematicians on screen

Sophie Dabo-Niang, Maria J. Esteban,  
Colette Guillopé and Marie-Françoise Roy  
Aspects of the gender gap in mathematics

Christian F. Skau

Interview with Martin Raussen

Ulf Persson

Jacob Murre (1929–2023)  
A gentle mathematician



# Journal of the European Mathematical Society



The **Journal of the European Mathematical Society (JEMS)** is the official journal of the EMS.

JEMS will publish research articles in all active areas of pure and applied mathematics. These will be selected by a distinguished, international board of editors for their outstanding quality and interest, according to the highest international standards.

The first Editor-in-Chief of the journal was Jürgen Jost, succeeded by Haïm Brezis in 2004, François Loeser in 2014, and Barbara Kaltenbacher in 2019. The current Editors-in-Chief are Anton Alekseev and Susanna Terracini.

#### Editors-in-Chief

Anton Alekseev (Université de Genève)

Susanna Terracini (Università degli Studi di Torino)

#### Editorial Board

Miklós Abért; Ilka Agricola; Costante Bellettini; Jean Bertoin;  
Ana Caraiani; Alexandra Carpentier; Antonin Chambolle;  
Isabelle Gallagher; Filippo Gazzola; Tamás Hausel; Tuomas Hytönen;  
Ilia Itenberg; Peter Keevash; Bernhard Keller; Ciprian Manolescu;  
Carlos Matheus Silva Santos; Kaisa Matomäki; Eva Miranda;  
Thomas Nikolaus; Paul Arne Østvær; Alena Pirutka; Angela Stevens;  
Denis Talay; Katrin Tent; Éric Vasserot; Luis Vega

For more details visit [ems.press/jems](https://ems.press/jems)

EMS Press is an imprint of the  
European Mathematical Society – EMS – Publishing House GmbH  
Straße des 17. Juni 136 | 10623 Berlin | Germany

<https://ems.press> | [info@ems.press](mailto:info@ems.press)



- 3 A message from the president  
*Jan Philip Solovej*
- 4 Women mathematicians on screen  
*Paolo Bellingeri*
- 11 Interview with Martin Raussen  
*Christian F. Skau*
- 22 Aspects of the gender gap in mathematics  
*Sophie Dabo-Niang, Maria J. Esteban, Colette Guillopé and Marie-Françoise Roy*
- 32 Expanding our horizons: Research with developing countries  
*Christophe Ritzenthaler*
- 36 EURO conferences  
*Graham Rand*
- 40 Are old mathematicians useless?  
*Albrecht Pietsch*
- 43 Jacob Murre (1929–2023)  
A gentle mathematician  
*Ulf Persson*
- 46 ERME column  
*Reidar Mosvold, Mark Hoover, Helena Grundén, Siún Nic Mhuirí and Chrysoula Choutou*
- 49 ICMI Column  
*Núria Planas*
- 54 The extension of zbMATH Open by arXiv preprints  
*Isabel Beckenbach, Klaus Hulek and Olaf Teschke*
- 59 Solved and unsolved problems  
*Michael Th. Rassias*
- 65 Book reviews

*Editor-in-Chief*

Fernando Pestana da Costa  
Universidade Aberta  
[fcosta@uab.pt](mailto:fcosta@uab.pt)

*Editors*

António B. Araújo (Art & mathematics)  
Universidade Aberta  
[antonio.araujo@uab.pt](mailto:antonio.araujo@uab.pt)

Karin Baur (Raising public awareness)  
University of Leeds  
[k.u.baur@leeds.ac.uk](mailto:k.u.baur@leeds.ac.uk)

Jean-Bernard Bru (Contacts with SMF)  
Universidad del País Vasco  
[jb.bru@ikerbasque.org](mailto:jb.bru@ikerbasque.org)

Krzysztof Burnecki (Industrial mathematics)  
Wrocław University of Science and Technology  
[krzysztof.burnecki@pwr.edu.pl](mailto:krzysztof.burnecki@pwr.edu.pl)

Jason Cooper (Maths education)  
Weizmann Institute of Science  
[jason.cooper@weizmann.ac.il](mailto:jason.cooper@weizmann.ac.il)

Jezabel Curbelo (Research centers)  
Universitat Politècnica de Catalunya  
[jezabel.curbelo@upc.edu](mailto:jezabel.curbelo@upc.edu)

Donatella Donatelli (Book reviews)  
Università degli Studi dell'Aquila  
[donatella.donatelli@univaq.it](mailto:donatella.donatelli@univaq.it)

Vesna Iršič (Young mathematicians column)  
University of Ljubljana  
[vesna.irsic@fmf.uni-lj.si](mailto:vesna.irsic@fmf.uni-lj.si)

Ralf Krömer (History of mathematics)  
Bergische Universität Wuppertal  
[rkroemer@uni-wuppertal.de](mailto:rkroemer@uni-wuppertal.de)

Youcef Mammeri (Features and discussions)  
Université Jean Monnet Saint-Étienne  
[youcef.mammeri@math.cnrs.fr](mailto:youcef.mammeri@math.cnrs.fr)

Ivan Oseledets (Features and discussions)  
Skolkovo Institute of Science and Technology  
[i.oseledets@skoltech.ru](mailto:i.oseledets@skoltech.ru)

Octavio Paniagua Taboada (Zentralblatt column)  
FIZ Karlsruhe  
[octavio@zentralblatt-math.org](mailto:octavio@zentralblatt-math.org)

Ulf Persson (Interviews and discussions)  
Chalmers Tekniska Högskola  
[ulfp@chalmers.se](mailto:ulfp@chalmers.se)

Michael Th. Rassias (Problem corner)  
Hellenic Military Academy, Greece  
[mthrassias@yahoo.com](mailto:mthrassias@yahoo.com)

Marie E. Rognes (Features and discussions)  
Simula Research Laboratory, Oslo  
[meg@simula.no](mailto:meg@simula.no)

The views expressed in the *European Mathematical Society Magazine* are those of the authors and do not necessarily represent those of the European Mathematical Society (EMS) or the Editorial Team.

For advertisements and reprint permission requests please contact [magazine@ems.press](mailto:magazine@ems.press).

Published by EMS Press, an imprint of the European Mathematical Society – EMS – Publishing House GmbH Technische Universität Berlin, Institut für Mathematik, Straße des 17. Juni 136, 10623 Berlin, Germany

<https://ems.press>

Typesetting: Tamás Bori, Nagyszékely, Hungary  
Printing: Beltz Bad Langensalza GmbH, Bad Langensalza, Germany

ISSN (print) 2747-7894; ISSN (online) 2747-7908

© 2024 European Mathematical Society

© ⓘ The content of this issue is licensed under a [CC BY 4.0 license](https://creativecommons.org/licenses/by/4.0/), with the exception of advertisements, logos and branding of the European Mathematical Society and EMS Press, and where otherwise noted. Also excluded are the images on pages 3–9, 13, 16, 36–38, 43–45, 50, 65, 66.

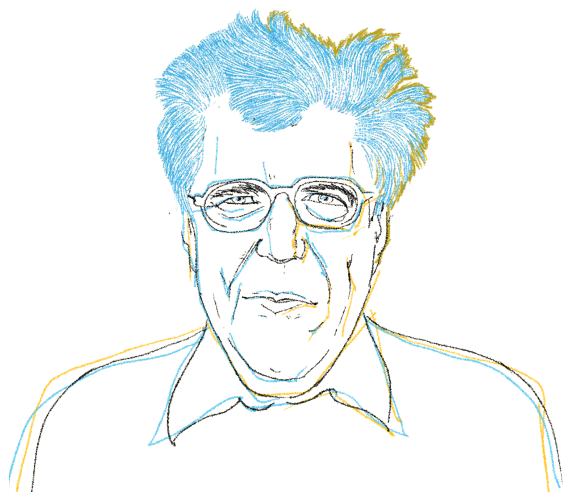

The cover illustration is a portrait by A. B. Araújo of Jacob Pieter Murre (18 September 1929 – 9 April 2023), based on photographic reference. The original photograph by Renate Schmid can be found at [https://opc.mfo.de/detail?photo\\_id=6602](https://opc.mfo.de/detail?photo_id=6602).

## A message from the president



Photo by Jim Høyer,  
University of Copenhagen.

For the European Mathematical Society, the big event of 2024 is the Ninth European Congress of Mathematics (ECM) to be held in Seville, Spain from 15 to 19 July. The lists of plenary and invited speakers have been announced on the [website](#).<sup>1</sup> Additionally, the congress will feature an Abel lecture with Avi Wigderson, from the Institute for Advanced Study in Princeton, and a Hirzebruch lecture with Étienne Ghys, from the École Normale Supérieure in Lyon. As something new, there will be special events for early career researchers, organized by the European Mathematical Society Young Academy (EMYA). These will include EMYA lighting talks and an EMYA ice-breaking session. EMYA will also be organizing a panel discussion on sustainability.

Moreover, it will be exciting to see at the ECM who will be this year's winners of the ten ECM prizes, the Felix Klein Prize in applied mathematics, the Otto Neugebauer Prize for the history of mathematics, and our two new prizes: the Lanczos Prize for mathematical software, and the Paul Lévy Prize in probability.

ECM promises to be an exciting event. Not only is it inspiring because of the program, but also because this is a great opportunity for mathematicians across Europe to meet and celebrate mathematics.

The deadline for early registration has already passed. If you did not register in time for this, I encourage you to do so before the regular deadline 31 May 2024. Since you are reading this Magazine, you are probably already an individual member of the EMS, in which case you will save 100 Euros on the ECM registration, which for many of us is equal to the total EMS membership fee before the next congress. Students of course face a much lower fee altogether. I hope you will encourage your colleagues who may

not read the Magazine to join us in Seville and to become members of the EMS.

Let me use this opportunity to highlight the new online EMS membership database, which allows EMS members to update their personal information and see all their subscriptions. New features will be added in the future.

I will not keep you for too much longer, as I am excited for you to read the rest of this issue, no. 131, of the EMS Magazine. I would nevertheless like to conclude with two important changes regarding EMS publications. As of 1 January 2024, Barbara Kaltenbacher has stepped down as editor-in-chief of the Journal of the European Mathematical Society (JEMS). Susanna Terracini has taken over from Barbara and is joining Anton Alexeev as part of the editor-in-chief team of JEMS. We are all indebted to Barbara for the hard work she has invested in JEMS. We owe her and Anton credit for the recent success we have seen in the development and flourishing of the journal. I am sure JEMS will continue to excel now with Susanna and Anton at the helm.

The final point I would like to make with this message is that the next issue, no. 132, of the EMS Magazine will be the last with Fernando Manuel Pestana da Costa as Magazine editor-in-chief. Fernando has been editor-in-chief since 2020 and has been on the editorial board since 2017. Though it is still a little too soon to say goodbye to Fernando, as he will be editing one more issue of the Magazine, he will be greatly missed. We thank Fernando for all his hard work and dedication to the Magazine. I am thrilled to announce that Donatella Donatelli has accepted our invitation to take over from Fernando. Donatella has been the book reviews editor for the Magazine since 2021. I am very much looking forward to working closely with Donatella and I hope you will all join me in welcoming her as editor-in-chief for the EMS Magazine.

I hope to see many of you in Seville in July!

Jan Philip Solovej  
President of the EMS

---

<sup>1</sup> <https://www.ecm2024sevilla.com>

## Women mathematicians on screen

English translation of the article entitled “Les mathématiciennes à l’écran” and published in *La Gazette des Mathématiciens*, Number 173, July 2022

Paolo Bellingeri

*While remaining a very rare phenomenon, female mathematicians do appear in movies, often as protagonists, revealing the director’s real commitment to character building. The aim of this article is to explore the representation of female mathematicians on screen, both fictional and real, of all ages and from different eras, to spot cliché, observe shifts in perspective and identify specific aspects that make the female role particularly important, not only from a narrative point of view, but also as for the intended message of the movie.*

In 2020, during the Pariscience International Science Film Festival, the documentary *Secrets of the Surface: The Mathematical Vision of Maryam Mirzakhani*, directed by George Paul Csicsery with the support of Berkeley’s Mathematical Science Research Institute, was shown on the festival’s TV platform. The health crisis has particularly hampered the distribution of this documentary, which, without much fanfare, makes its way from festival to festival alongside mathematical conferences, but is now finally starting to become better known, thanks in particular to various initiatives to promote the sciences among young girls. The movie is a tribute to the mathematical work and the person of Maryam Mirzakhani (Figure 1):



Figure 1. Maryam Mirzakhani in *Secrets of the Surface*. © Zala Films

we follow her at Teheran Girls’ High School, at the International Mathematical Olympiad (with her two gold medals), during her studies at Sharif University of Technology and Harvard, and later at Stanford, at the time of her Fields Medal in 2014, before concluding with images of and interviews with young pupils and university students in Iran who show the impact and influence of her persona in the dissemination of mathematics in her native country.

The movie offers several levels of interpretation: we “see” mathematics and mathematical places, and we listen to mathematicians describing the importance and fruitfulness of Maryam Mirzakhani’s work. We also learn about personal, sometimes dramatic moments in her life, and feel the emotions of those who were close to her. These different paths allow us to sketch a portrait of Maryam Mirzakhani as a whole, and effectively show how the mathematical and human planes are intertwined, rejecting the usual cliché of the cold, asocial mathematician isolated in his or her own world.

At the same time, the movie introduces us to the Iranian education system (Figure 2), which was one of the director’s stated aims and could represent an interesting starting point for a future discussion on the topic of “girls in scientific disciplines.”

George Paul Csicsery has dedicated much of his career to documentaries about the mathematical community. Probably the



Figure 2. Iranian university students in *Secrets of the Surface*. © Zala Films

best-known of his documentaries is the first, *N is a Number: A Portrait of Paul Erdős* (1993), which depicts the life and mathematics of Paul Erdős. The figure of Erdős fascinated Csicsery, who subsequently decided to continue his journey among contemporary mathematicians.

Let us mention *Julia Robinson and Hilbert's Tenth Problem* (2008) at this point, because there are several motifs in this film that were later taken up in *Secrets of the Surface*: the difficulties inherent in being a woman in a man's world, the parallel description of the individual and their mathematics, but above all the vision of Mathematics overcoming borders and differences. The documentary also looks at Julia Robinson's scientific cooperation with Yuri Matiyasevich, at the height of the Cold War. Through these multiple aspects, the film reflects Julia Robinson's vision of mathematicians as citizens of a nation, irrespective of place, gender, religion or even time [1, 4].

Csicsery's work is particularly noteworthy given the scarcity of documentaries on female mathematicians; indeed, we need to broaden the spectrum of media and look further afield, to the past and to other cinematographic genres. We might mention, for example, the comics doc *Je suis Sophie Germain, femme et mathématicienne* (2021), produced to coincide with the release of the comic strip *Les Audaces de Sophie Germain* [5], or *Girls who fell in love with Math* (2017), a Taiwanese documentary about mathematicians Alice Zhang and Fan Chung Graham. Even in Olivier Peyon's documentary *Comment j'ai détesté les mathématiques* (2013), there are hardly any female mathematicians: the only woman to appear in a proper role in this story is a psychologist who treats math phobia in children....

## 1 Mathematicians and heroines, from *Agora* to *Hidden Figures*

Leaving the world of documentaries behind, movies about "real" female mathematicians remain isolated and hard to find. Take, for example, Sofya Kovalevskaya, whose life lends itself particularly well to cinematic transposition, as was the case recently for John Nash (*A Beautiful Mind* by Ron Howard, 2011), Srinivasa Ramanujan (*The Man Who Knew Infinity* by Matt Brown, 2015) or Alain Turing (*The Imitation Game* by Morten Tyldum, 2014). In [1], which is a remarkable work on mathematics and cinema, the authors cite three movies about the Russian mathematician: of the first, made in the USSR in 1956 and entitled *Sofya Kovalevskaya*, the authors were just able to discover the existence and director (Iosif Shapiro)<sup>1</sup> while the other two are a Swedish movie from 1983 (*A Hill on the*



Figure 3. Hypatia teaching in *Agora*. © Focus Features/Fox International

*Dark Side of the Moon* by Lennart Hjulström) and a Soviet mini-series from 1985 (*Sofya Kovalevskaya*<sup>2</sup>). These works, however, are somewhat distant to us, in time as well as in terms of availability.

There are two movies which stand out as exceptions from this statement, and we can wonder whether they represent a change of perspective and the start of a new trend: *Agora* (2009) and *Hidden Figures* (2016). The mathematics of these two movies are detailed in [3], while here we will focus on the representation of female mathematicians and their activity.

*Agora* (Figure 3) is, cinematically speaking, a *peplum*, which is original in its theme and approach. The action is set in Egypt between 390 and 415: the protagonist is Hypatia of Alexandria, played by Rachel Weisz, a neoplatonic philosopher and the first female mathematician we know of. While we have some information on her research (in particular, she had studied Ptolemy's astronomical texts, which justifies the movie's discussions of the Earth's position in relation to the Sun) and her tragic end (she was murdered), there is no written record of her work. This allowed the director (Alejandro Amenábar) a great deal of freedom in constructing the character, in particular, from a mathematical point of view: the movie talks about mathematics known at the time (Euclid and the Apollonius cone are cited, among others) but, as noted in [3], it remains highly improbable that Hypatia could have discovered the Earth's elliptical trajectory, and even less so through the approach proposed in the movie, based essentially on the gardener's method of tracing an ellipse.

In terms of historical facts, there were quite a few liberties taken, too: Hypatia's assassination was made to coincide with the destruction of the Temple of Serapis (where the remains of the Library were kept), and was attributed to the Christians. Without entering into

<sup>1</sup>The author is thankful to the language editor for finding a copy of the movie: <https://www.youtube.com/watch?v=kMMCFa8qEUA>, and of another TV film about Sofya Kovalevskaya: <https://www.youtube.com/watch?v=zVRV-o0z5pg>.

<sup>2</sup>This mini-series, which saw the debut of actress Yelena Safonova, has the particularity of being a movie about a "real" mathematician that was directed by a woman, Ayan Shakhmaliyeva.



Figure 4. *Hidden Figures*: the “colored computers.” © 20th Century Fox



Figure 5. A blackboard in *Hidden Figures*. © 20th Century Fox

discussions of a historical or epistemological nature, this set of narrative choices, which incidentally contrast with the meticulous and aesthetically pleasing reconstruction of Alexandria, transforms the character of Hypatia into pure fiction, reducing her to the message the movie wishes to convey: that of science confronting obscurantism and fanaticism. Nonetheless, the movie remains a singular and interesting tribute to an important figure in history (not just in mathematics) who had hitherto been ignored by the world of cinema.

*Hidden Figures* is a biographical movie directed by Theodore Melfi. It is based on Margot Lee Shetterly’s book about three African American female mathematicians who worked at NASA during the space race: Mary Jackson (Janelle Monáe), Katherine Johnson (Taraji P. Henson) and Dorothy Vaughan (Octavia Spencer) (the three actresses in the foreground in Figure 4). The movie also stars Kevin Costner, Kirsten Dunst and Jim Parsons (again playing the role of a physicist, as in *The Big Bang Theory* TV series), among others. Despite its initially rather modest release, *Hidden Figures* proved to be one of the most profitable movies of 2016, grossing 236 million USD worldwide and receiving rave reviews from critics, along with three Oscar nominations, including for Best Picture.<sup>3</sup>

Mary Jackson, Katherine Johnson and Dorothy Vaughan were among the “computer women” at NASA whose commitment contributed to the success of the first space missions, but who were subsequently overlooked by history. As is often the case, the movie compromises with reality (it is not a documentary): for example, the action is concentrated on the years 1961 and 1962, whereas the three women did not work at NASA in that period, and the chronology of most of the facts cited is not respected. More important, however, is the fact that the movie remains essentially “true.”

Dorothy Vaughan was the first African American woman to be appointed team supervisor at NASA (in programming) and one of the pioneers of FORTRAN programming. In parallel, Mary Jackson is highlighted for her fight to abolish anti-segregation laws in the United States (she was allowed to take courses reserved for whites) and for her career path that led her to become the first black woman engineer at NASA. The leading role in the movie is given to Katherine Johnson and her work as a mathematician on the trajectory calculations for John Glen’s Mercury mission in 1962. As far as mathematics are concerned, it is first of all worth noting that they are omnipresent in the movie, serving as backdrops: there are some forty blackboards (Figure 5) where formulas ranging from quadratic equations to trajectory calculations are sketched out. There are also a few shortcuts or even mistakes, for example in the scene in which Katherine Johnson demonstrates her mathematical skills by finding a good approximation to the landing coordinates (in which the actress seems to confuse the initial data with the result [3]), or in the presentation of Euler’s method as a solution for calculating the instant of passage to change John Glen’s capsule from an elliptical to a parabolic trajectory (it was rather variants, such as those of Runge–Kutta, which are far more reliable, that were actually used). However, this does not detract from the message. We see three women asserting themselves in three different fields: applied mathematics, space engineering and computer science. And even if the story remains a fairly classic one of the American dream, we appreciate the depiction of mathematics as being a key to development, thanks to both personal and collective skills, as in the scene where the “colored computers” are transferred to the IBM computer section. Mathematics can thus help overcome discrimination, in the spirit of Julia Robinson and her idea of mathematicians as a common nation, as the three women, in three different scenes, are finally accepted as colleagues and scientists.

In this sense, the movie is also reminiscent of *The Man Who Knew Infinity* when describing the relationship between Hardy and

<sup>3</sup>While *A Beautiful Mind* is so far the only movie about mathematics to have won an Oscar, two other “mathematical” movies had received a nomination before *Hidden Figures*: *The Imitation Game* and Bennet Miller’s *Moneyball*, 2011.



Ramanujan (at first essentially mathematical and complicated by cultural differences) and then Hardy's struggle to have Ramanujan's work recognized. Similar themes are dealt with in the mini-series *The Bletchley Circle*, which follows four women (played by Julie Graham, Anna Maxwell Martin, Sophie Rundle and Rachael Stirling) who worked at Bletchley Park, a British code-breaking site during the Second World War, which is also the setting for *The Imitation Game*. After the end of the war, having sworn not to reveal their wartime activities and being forced to return to the not-so-stimulating daily lives of housewives or secretaries, they set out to solve criminal investigations using their logic and reasoning skills. Without pretending to do historical studies, it is interesting to observe how, in both cases, women were able to enter a man's world – the world of war or the conquest of space – thanks to their skills, but also to the high demand of such skills, being later (once these exceptional circumstances had disappeared) totally disregarded for reasons of state secrecy and, above all, obvious discrimination.

## 2 Women mathematicians in fiction: clichés and singularities

After talking about “real” women mathematicians in documentaries and movies, let us move on to the “fictional” women mathematicians. A puzzling remark at first sight concerns the percentage of female mathematicians on screen, which seems higher than in real life. In fact, in movies dealing with mathematics, women mathematicians are very much in evidence. Of course, this observation needs to be put into perspective, given the (under)representation of mathematics in cinema. *The Mathematical Fiction* site cites around 160 movies that deal (at least vaguely) with mathematics, while *Mathematics in Movies* lists around 170 excerpts of mathematics in movies<sup>4</sup>: they are negligible numbers in relation to the worldwide film production. What is more, we note that on the rare occasions when mathematics is mentioned in cinema, it is to complain about it. In *Hollywood hates maths* Dan Mayer reminds us that mathematics often appears on screen in the form of little negative phrases, which represent a “fictional” mirror of the difficult relationship audiences can have with mathematics. While mathematics is often “mistreated” in movies and sometimes reduced to comic effects, female mathematicians are portrayed with recurring clichés that are, incidentally, the same as those found for their male colleagues. They are cold (granddaughter Therèse in *Antonia's Line* by Marleen Gorris, 1995), shy or awkward (the protagonist of *She Wrote the Book* by Charles Lamont, 1946), sometimes troubled by alcoholism or other addictions (Béatrice Dalle, alcoholic logician in *Domaine* by Patric Chiha, 2008) or even suicidal. In the mini-series



Figure 6. The actresses of *Sky Castle*. © JTBC

*The Queen's Gambit*, the protagonist's mother (played by Chloe Pirrie) is a mathematician (at one point she burns her doctoral thesis in *Mathematics: Monomial Representations and Symmetric Presentations*) who suffers from severe mental problems that drive her to deliberately kill herself in a car, while also trying to get rid of her own daughter (perceived by the mother as “a problem to be solved”).

Sometimes women mathematicians are also murderers.<sup>5</sup> In Alan Pakula's *Presumed Innocent* (1990), Bonnie Bedelia plays a mathematician who fails to complete her studies and kills the lover and colleague of her husband (Harrison Ford). In the Korean series *Sky Castle* (2018, Figure 6) Kim Seo-hyung plays an entrance exam preparer at Seoul National University (SNU), South Korea's most prestigious university. Since all her students succeed in getting into SNU, she is highly sought-after by Seoul's wealthy families. In reality, she is a high-level mathematician who has emigrated to the USA and is hiding a dark secret. In conflict with her husband over the education of their gifted daughter, she causes a car accident in which her daughter is also involved, leaving her handicapped for life. Back in Korea, in search of revenge, she tries to destroy the families who entrust her with their children, and ends up committing another murder after that of her husband in the USA. *Sky Castle*, which is a fierce critique of the Korean education system and a major box-office hit in Asia, shows the importance of mas-

<sup>5</sup> This is the case with male mathematicians, too, who may even be multi-murderers (*Straw Dogs* by Sam Peckinpah, 1976), serial killers (*Bianca* by Nanni Moretti, 1983) or contract killers (*The Accountant* by Gavin O'Connor, 2016).

<sup>4</sup> It should be remembered, too, that there are several excerpts from the same movie, and that some excerpts are very short, even insignificant.

tering mathematics in the ruthless selection of Korean students, and features numerous teaching scenes (in class, in private lessons, between students).

In both *Presumed Innocent* and *Sky Castle*, the validity of the murderous plan is “certified” by the fact that the killer is a mathematician, and therefore “by definition” intelligent and not very empathetic. However, the motivations behind the murders and the work on the character are very different: In *Presumed Innocent*, the fact that the murderer is a mathematician is of marginal importance, adding professional frustration (the unfinished thesis) to the personal frustration (the husband’s betrayal) of the gap between reality and the desire for a world governed by clear, unchanging rules. By contrast, the woman mathematician in *Sky Castle* is a far more complex character: there is the social affirmation through mathematics, the difficulty of relating to others (to one’s own child), the retribution and revenge against a society that sees preparators (and mathematics) as essential means, but which can be discarded once admission to a major university has been achieved.

*Presumed Innocent* is not the only example. Mathematical characters are rarely explored in depth in cinema. Most of the time, we discover a woman mathematician by watching her write mathematics on a blackboard: scenes that create context, justified by the plot, but which remain narratively secondary. That said, these scenes can be of high quality, even from a mathematical point of view: in Claudia Weill’s *It’s My Turn* (1980), the protagonist is a university professor (played by Jill Clayburgh), and in one scene she demonstrates the Snake Lemma to students. It is also curious to note the analogies with Marleen Gorris’ *Antonia’s Line*: two movies by two female directors in which mathematicians discuss homological algebra on a blackboard. The proof is correct and this scene is quoted in *An Introduction to Homological Algebra* by Charles Weibel [6], who writes:

We will not print the proof in these notes, because it is best done visually. In fact, a clear proof is given by Jill Clayburgh at the beginning of the movie *It’s My Turn*.

However, as in the case of movies about real-life female mathematicians, we have seen a growing focus on the character construction over the years. Examples include two relatively recent movies, *Proof* (2005) and *Gifted* (2017), which break away from certain stereotypes and tackle new subjects.

*Proof*, directed by John Madden (Figure 7), is a cinematic adaptation of David Auburn’s 2001 Pulitzer Prize-winning play of the same name. The narrative alternates between events following the death of a brilliant mathematician (Anthony Hopkins) from dementia, and flashbacks to the life he shared with his daughter Catherine (Gwyneth Paltrow). Being also a mathematician, she interrupted her studies to take care of her father and also because of personal problems (she struggles with the imposing father figure, whose mental illness she fears she has inherited).



Figure 7. The protagonists of *Proof*. © Miramax Films

The proof referred to in the movie seems to be that of the Riemann hypothesis; even though this choice may appear incongruous, it is functional to the narrative, as it would seem natural for us too to doubt any possible proof! The movie follows Catherine’s painful journey, her fear of sinking into madness, the difficulty of asserting herself as a mathematician, but above all it tackles the problem of the paternity (maternity, in this case) of a proof. Catherine makes Hal (Jake Gyllenhaal), the father’s former student, find a notebook with an important proof, claiming that it was she who wrote it, not her father. Neither Hal nor Catherine’s sister Claire (Hope Davis) believe her. Hal and Claire embody Catherine’s fears, that is that she could not live up to her father’s standards (Hal thinks the mathematics used in the notebook are beyond Catherine’s grasp) and that she is also mentally ill (her sister Claire’s suspicion). It is only towards the end of the movie that Hal, after discussions with colleagues, says he believes her (the mathematics used are new) and wants to discuss the proof with her. Shortly afterwards, Catherine faces her fears, deciding to stay and not leave with her sister. In this sense, the movie, without really showing mathematics, proposes a scientific path that may seem plausible, describing the difficulties that can arise for a woman mathematician in a man’s world (the only other mathematicians who appear in the movie, living or dead, are men). A discussion of Catherine’s career also touches on the underrepresentation of women in mathematics. The heroine mentions Sophie Germain as an example of a great female mathematician.

Marc Webb’s *Gifted* (French title: *Mary*) tackles the subject of gifted children. The protagonist is Mary (Mckenna Grace), a seven-year-old girl with an uncommon aptitude for mathematics, who is the subject of a violent difference of opinion between her uncle Frank (Chris Evans) and her grandmother Evelyn (Lindsay Duncan) concerning the way she should be raised. The former, who has been her guardian since the suicide of his sister, Mary’s mother and a brilliant mathematician, would like to ensure her a normal childhood (also in the light of his own experience), while her grandmother wants to take her back to Massachusetts and enroll her in a school for geniuses. The motif of the mathematically gifted child is not new: it can also be found in *Dear Brigitte* (by Henry Koster,

1965), *Little Man Tate* (by Jody Foster, 1991) and *Antonia's Line*. The originality of *Gifted* lies in the attention it pays to mathematics and its contextualization in the narrative. Director Marc Webb, the son of an educational mathematician, has surrounded himself with four mathematical consultants. The mathematical theme may come as a surprise, as it is nothing less than Navier–Stokes: moreover, at the end of the movie we discover that this millennium problem (yet another one<sup>6</sup>) was demonstrated by Mary's mother, who wanted it to remain a secret until her mother Evelyn's death.

Like *Proof*, *Gifted* also shows the impact of the Millennium Prize Problems on the collective imagination, but unlike *Proof*, *Gifted* immerses us in mathematics. These are surprisingly correct for fiction, although their spectrum is very scattered (we encounter Trachtenberg, congruences and integrals). Particularly striking is the scene in which a teacher challenges Mary to prove the equation in Figure 8:

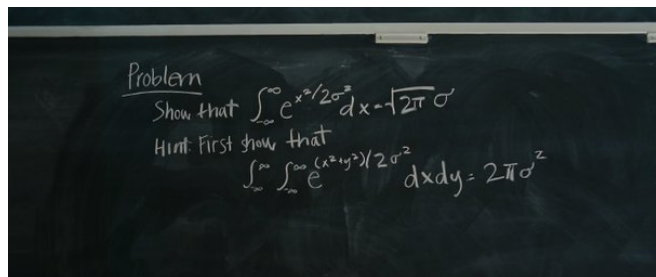

Figure 8. A question in *Gifted*. © Fox Searchlight Pictures

Mary does not answer because she has been advised not to correct grown-ups, but she eventually comes back and corrects the equation on the blackboard by adding a “–” sign in front of  $x^2$  and putting  $\sigma$  as an absolute value (Figure 9).

The absolute value is actually unnecessary, as the standard deviation is a positive number. As Cottanceau remarks, “this little detail shows that Mary has great intuition ... but not yet enough experience to contextualize the problems presented to her.” The demonstration finally seems correct, and this scene is coherent “in the parallel universe where a first-grade girl shows such abilities” [3].

### 3 Conclusion

Over the last few years, it seems that cinema's view of mathematics has evolved towards a more complex and sophisticated approach,

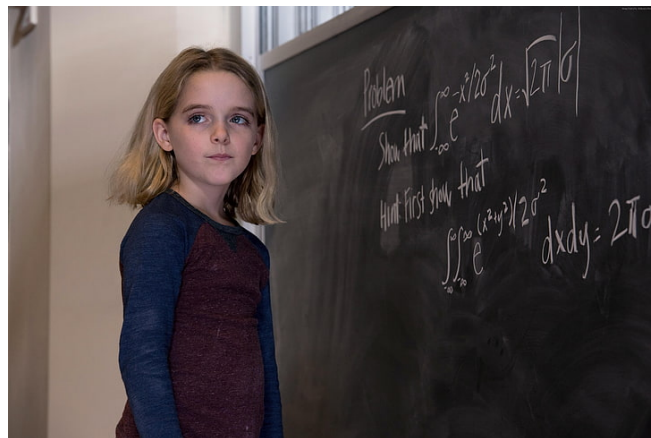

Figure 9. Mary corrected the equation on the blackboard. © Fox Searchlight Pictures

and therefore a more realistic and convincing one. While we cannot ask cinema to explain mathematics (that is not its role), we can applaud the fact that recent works show us that it is possible to be passionate about mathematics, and how they can be interesting and convey positive messages. Even if certain stereotypes appear to persist, male and female mathematicians are increasingly emerging as characters in their own right who deserve to be developed cinematically. Female mathematicians, whether real or fictional, are particularly interesting because they enable directors and screenwriters to tackle a number of other themes in parallel: the conflicting relationship between what is rational and what is emotional (traditionally embodied by female sensibility in cinema), discrimination, the difficulty of emerging scientifically in a world of men. On the other hand, we see the strength of belonging to a community, primarily of women, as in *The Bletchley Circle* or *Hidden Figures*, or more generally, as part of the mathematical “nation,” the one Julia Robinson spoke about.

In conclusion, the number of documentaries and movies about female mathematicians who actually existed is extremely limited, even within the cinematic niche of “mathematical” movies. As far as movies made by women are concerned, to the four we have mentioned above (*Antonia's Line*, *It's My Turn*, *Sofya Kovalevskaya*, *Little Man Tate*) we can add *C'est la tangente que je préfère* by Charlotte Silvera (1997), in which the protagonist is a young girl very gifted in logic. This is not an insignificant sample, and all these movies have met with some degree of public and/or critical success. That said, they are all concentrated on a short period of time, and, to my knowledge, no other female director has completed a mathematical movie (with international distribution) since 1997.<sup>7</sup>

<sup>6</sup>Another millennium prize problem solved in cinema is “P = NP,” in an episode of the series *Elementary*, to be precise. In fact, it is stated that the mathematician found dead had demonstrated “a third of it,” which, as Jean-Paul Delahaye remarked, is a rather astonishing statement for us. Note also that the murderer is, once again, a mathematician.

<sup>7</sup>This was the case at the moment of the publication of the French version of the paper: in November 2023, the movie *Le Théorème de Marguerite*, about a female PhD student in mathematics, was released, directed by Anna Novion.

This is actually a more general problem: just as an example, out of around 21,000 European feature films between 2003 and 2017 (European Audiovisual Observatory), only one in five was directed (or co-directed) by a woman. Yet another point that mathematics and cinema have in common: the road to equality is still a long one.

*Acknowledgements.* I would like to thank Marie Bocquillon, Marc Demeuse and Antoine Derobertmeasure, editors of *L'École à travers l'art et la (pop)culture*, published by Mardaga, for allowing me to reproduce some of the ideas and texts from my contribution [2]. The *EMS Magazine* thanks *La Gazette des Mathématiciens* for authorisation to republish this text, which is an English translation of the paper entitled "Les mathématiciennes à l'écran" and published in *La Gazette des Mathématiciens*, Number 173, July 2022.

### Sitography

- Gender equality for film directors: Still a long way to go. Yearbook 2019/2020 European Audiovisual Observatory, <https://rm.coe.int/yearbook-keytrends-2019-2020-en/16809ce58d>
- Mathematical Fiction. <https://kasmana.people.cofc.edu/MATHFICT/all.php> (2021)
- O. Knill, Mathematics in movies. <https://people.math.harvard.edu/~knill/mathmovies> (2006)
- D. Mayer, Hollywood hates maths. <https://youtube.com/watch?v=NoaD-elyC5g> (2013)
- A. Boyer, H. Pajot and F. Bastien, Je suis Sophie Germain, femme et mathématicienne. <https://www.canal-u.tv/chaines/4fourier/je-suis-sophie-germain-femme-et-mathematicienne> (2021)
- J.-P. Delahaye, <https://interstices.info/pnp-elementaire-ma-chere-watson> (2014)

### Filmography (by directors)

- A. Amenábar, *Agora*. Fox International Production, Spain (2009)
- M. Brown, *The Man Who Knew Infinity*. Pressman Film, UK (2015)
- P. Chiha, *Domaine*. Aurora Films, Austria/France (2010)
- G. Csicsery, *N is a Number: A Portrait of Paul Erdős*. USA (1993)
- G. Csicsery, *Julia Robinson and Hilbert's Tenth Problem*. USA (2008)
- G. Csicsery, *Secrets of the Surface: The Mathematical Vision of Maryam Mirzakhani*. Zala Films, USA (2020)
- J. Foster (woman), *Little Man Tate*. Orion Pictures Corporation, USA (1991)
- L. Hjulström, *Berget på månens baksida* (A Hill on the Dark Side of the Moon). Moviemakers Sweden AB, Sweden (1983)
- R. Howard, *A Beautiful Mind*. Universal Pictures, USA (2011)
- M. Gorris (woman), *Antonia's Line*. PolyGram Video, Belgium/Netherlands (1995)
- Y.-J. Jiing and W. Wang, *Girls Who Fell in Love with Math*. Taiwan Film Institute, Taiwan (2017)
- H. Koster, *Dear Brigitte*. 20th Century Fox, USA (1965)
- C. Lamont, *She Wrote the Book*. Universal Pictures, USA (1946)
- J. Madden, *Proof*. Miramax, USA (2005)

- A. Makarenko, *Sofya Kovalevskaya: The Dilemmas of a Great Woman*. Bokun Studio, Russia (1997)
- T. Melfi, *Hidden Figures*. Fox 2000 Pictures, USA (2016)
- B. Miller, *Moneyball*. Columbia Pictures, USA (2011)
- N. Moretti, *Bianca*. Faso Film / Rete Italia, Italy (1984)
- A. Novion, *Le Théorème de Marguerite*. Pyramide Distribution, France (2023)
- G. O'Connor, *The Accountant*. Warner Bros, USA (2016)
- A. J. Pakula, *Presumed Innocent*. Warner Bros, USA (1990)
- S. Peckinpah, *Straw Dogs*. 20th Century Fox, UK/USA (1971)
- O. Peyon, *Comment j'ai détesté les mathématiques*. Haut et Court, France (2013)
- M. Tyldum, *The Imitation Game*. Black Bear Pictures, USA (2014)
- I. Shapiro, *Sofya Kovalevskaya*. Lenfilm, USSR (1956)
- C. Silvera (woman), *C'est la tangente que je préfère*. Canal+ / CNC, France (1997)
- M. Webb, *Gifted*. FilmNation Entertainment, USA (2017)
- C. Weill (woman), *It's My Turn*. Columbia Pictures, USA (1980)

### Television series

- *The Bletchley Circle*. 2 seasons. ITV, UK
- *Elementary*. Season 2, episode 2. CBS Television Studios, USA
- *The Queen's Gambit*. Netflix, USA
- *Sky Castle*. JTBC, South Korea
- *Sofya Kovalevskaya*. Gosteleradio, USSR

### References

- [1] S. Beccastrini and M. Nannicini, *Il Cinema e la Matematica: Sulle tracce di una promettente amicizia*. Erickson, Trento, Italy (2010)
- [2] P. Bellingeri, Langage universel, langage commun ? Comment le cinéma représente les mathématiques. In *L'École à travers l'art et la (pop)culture*, pp. 155–178, Mardaga, Bruxelles, Belgium (2022)
- [3] J. Cottanceau, *Les maths font leur cinéma : De Will Hunting à Imitation Game*. Dunod, Malakoff, France (2021)
- [4] M. Du Sautoy, *La symphonie des nombres premiers*. Points, Paris, France (2003)
- [5] E. Tartaglino, A. Filippini and A. Ferrari, *Les audaces de Sophie Germain*. Petit à Petit, Rouen, France (2021)
- [6] C. A. Weibel, *An introduction to homological algebra*. Cambridge Stud. Adv. Math. 38, Cambridge University Press, Cambridge, UK (1994)

---

Paolo Bellingeri is a lecturer and researcher in mathematics at the University of Caen Normandy, his research focuses on braid groups. He was the director of the Fédération de Recherche Normandie-Mathématiques (2017–2022), now he is the director of INSPÉ Normandie, Caen. He participates in the activities of the Laboratoire de Mathématiques Nicolas Oresme's mathematical culture team with workshops, conferences and articles on knot theory, tessellations and – not least – cinema.

[paolo.bellingeri@unicaen.fr](mailto:paolo.bellingeri@unicaen.fr)

# Interview with Martin Raussen

Christian F. Skau

*Christian Skau (Norwegian University of Science and Technology, Trondheim, Norway) and Martin Raussen (Aalborg University, Denmark) teamed up to interview the Abel Prize recipients, from the first one in 2003 and until 2016, when Bjørn Dundas (University of Bergen, Norway) took over from Martin Raussen. Just before the opening of the 29th Nordic Congress of Mathematicians, organized in cooperation with the European Mathematical Society at Aalborg, Denmark, a session took place with Christian interviewing Martin. The text below is a slightly edited version of the recorded interview.<sup>1</sup>*

## **Nordic Congress of Mathematicians**

Christian F. Skau: *Martin, the two of us have participated in many interviews together. This time there is nobody else to ask questions but me! We have a double special occasion: This afternoon the 29th Nordic Congress of Mathematicians, on the occasion of the 150 years anniversary of the Danish Mathematical Society, will get started here in Aalborg, and after the summer you will retire from your position at Aalborg University. Could you tell us about your involvement with the Nordic Congress?*

Martin Raussen: I will try to do that, but before, let me thank you for coming at this special occasion. I am very grateful that you took the effort to come here from Oslo, where the two of us, for several years, have interviewed the Abel Prize recipients.

Before I answer your questions: Interviewing the Abel Prize recipients was like mingling with Champions League winners in soccer. I am not at all in that league. I would have difficulties to



Martin Raussen.

qualify for the Conference League! Therefore, I am very honoured to be granted this opportunity to be interviewed.

I started to work on getting the Nordic Congress to Aalborg around five years ago. In the beginning it took only little time, writing letters and applications. Forming a good and reliable team for the organization was essential. During the last year tasks accelerated. For the last month we have been very busy, indeed. But now we are happy that we can host more than 400 congress participants. There will be eight plenary talks at the House of Music, and we will have 29 special sessions in a university building very close by. The only thing that could be better, in my view, is the weather that has deteriorated quite a lot lately.



**29<sup>TH</sup> NORDIC CONGRESS  
OF MATHEMATICIANS**

<sup>1</sup> [https://youtu.be/4\\_ab-SSKlg0](https://youtu.be/4_ab-SSKlg0)

## *First mathematical experiences*

CFS: *Let's now talk a little about you as a mathematician. My first question is: What kindled your interest and fascination with mathematics in the first place?*

MR: My late father was a high school teacher in mathematics and physics. He was very interested in the subject and talked to me, and also to my brothers and sisters, about mathematical topics. He tried to give us small challenges from time to time. The first problem I still remember came when I was still a small kid, maybe just started school, or maybe second grade. He asked me, in a concrete setting dealing with brown and white hens, a question that, in hindsight, can be phrased as two simple linear equations in two variables. I had no clue about how to tackle this problem, but the numbers were not that large. I could just experiment in my head, and I found the answer after a while. He commented that this was somewhat exceptional for a kid at that age, and I was proud.

The second instance that still is in my memory happened when I was a bit older. I had heard about the test to decide whether a number is divisible by three or by nine by just taking the sum of the digits. And I started to think: How about other division tests of that kind? I would never have been able to find out about division by seven at that time! But by experimenting just with two- or three-digit numbers, and those were the numbers that were in my mind at that time, I found out with 11 it's the alternate sum that does the job. It got me excited! I remember that I wrote a small note about my finding and distributed it to some of my friends in the school class. They were not really interested in it, but it was my first experience of mathematical success.

CFS: *That's a nice story! And a natural follow-up question: When did you discover that you really had special talent for mathematics?*

MR: Talent and interest are very much related. I was a little bit older, still under the influence of my father, who at that time got interested in Boolean algebra and related concepts with the advent of the first digital computers. He led a small workshop on Boolean algebra. I participated, and I got the impression that as soon as you have something that you can formulate in terms of Boolean algebra, then the computer can work for you.

I started to look at what happens when you take as operations the greatest common divisor and the smallest common multiple of natural numbers, respectively. This gives you a distributive lattice, but in most cases the divisors of a natural number do not form a Boolean algebra. It works only well for square-free numbers. In hindsight, this is clear, because then the lattice corresponds to the power set of the prime divisors, but I did not know that at the time. Anyway, I wrote a small note and even tried to get it published in a small educational journal. It didn't work out, but still, I remember

that I could tell myself: "I can somehow contribute to something that resembles a little bit of research." All that happened some time before I started to study at the university.

## *A mathematical education*

CFS: *Very nice. Then let's move to your mathematical training. Tell us about your mathematical education, starting with the Max-Planck-Gymnasium in Trier, and until you got your Ph.D. in mathematics at Georg August University in Göttingen.*

MR: That covers a range of years! I went to what's called Max-Planck-Gymnasium in Trier, in South West Germany. When people ask me about Trier, I answer: That is the city where Karl Marx was born! Apart from myself and many other people of course. The Max-Planck-Gymnasium, you can guess it from the name, was a high school where mathematics and natural sciences had a high level of esteem.

The other high schools in town either focused on old languages, Latin and Greek, or modern languages like French, which was important in Trier, being close to the borders of France and Luxembourg. At the Max-Planck-Gymnasium you were able to specialize in mathematical and physical directions, mainly during the last two or three years.

That gave me sort of a head start when starting at the University of the Saarland in Saarbrücken, around 100 kilometres south of Trier. I was only 17 years old then, and I started on an education in both mathematics and computer science, a subject that had just started a year earlier. In mathematics, we had to follow the standard curriculum: linear algebra and analysis. At first, I felt more at home in linear algebra because I had a rather algebraic mindset. I also liked to learn about Turing machines, computability, and formal languages in computer science.

Our analysis course consisted of three consecutive semesters that were given by a young professor at that time, Tammo tom Dieck, who had just got a professorship in Saarbrücken. He was a student of the famous topologist Dieter Puppe from Heidelberg. Professor tom Dieck did a very good job teaching us analysis from the elementary beginnings and ending with vector analysis. It was quite complicated stuff in the third semester. Both tom Dieck's personality, but also the drive of the group of young assistants surrounding him, his team, attracted me. It was the personalities of these people rather than the subject itself that impressed me most.

In retrospect, I am grateful for the inspiration they gave me. As a follow-up, there were offered courses in differential topology, which was developing rapidly at the time. After three further semesters we got close to the results on smooth structures on spheres by Kervaire and Milnor. Milnor became later one of our Abel interviewees! I felt a real challenge and excitement: After

the first three years at university, we were at a level where we could read and understand, to a certain degree at least, papers that had been written perhaps five or ten years earlier. There were also interesting seminars where we were challenged to give talks ourselves about papers in the literature.

I should add that I received a grant from Studienstiftung des deutschen Volkes, a grant institution for talented university students, with money that made me financially independent. Since I also earned some money as an instructor for new students, I felt quite well-off at the time! The Studienstiftung also gave opportunities to attend summer academies during the vacations at nice places, in the Alps usually. That was challenging! I got to know other eager and talented students. Moreover, interesting subjects, not only within mathematics, were taught and discussed.

All that brought me up to a certain level. I asked for a topic for a master's thesis, and I got a suggestion by tom Dieck. It took some time to get the right mindset; the topic was no longer in differential topology, but in algebraic topology. I had never taken a class in algebraic topology, but during seminars, I had acquired some knowledge. I finished this master thesis within perhaps a year, finally typing it myself on an old-fashioned typewriter and inserting special letters by hand.

But then something else happened: My teacher tom Dieck was called to a professorship in Göttingen. Consequently, the whole team, his assistants and several of his students, followed him to Göttingen. My master's degree was obtained at the University of the Saarland, but the final oral exam took already place in Göttingen.

## Göttingen

Saarbrücken and Göttingen are quite different. Göttingen has a lot of tradition: You can still walk to the observatory where Gauss worked, and the hall you enter at the department of mathematics is called the Hilbert space. You can walk along the offices where so many illustrious mathematicians had worked. The buildings of the department of mathematics, and that of physics nearby, had been built with support from the Rockefeller Foundation after the First World War.

CFS: *And they were not destroyed during the Second World War?*

MR: Göttingen was almost intact; only a few buildings were damaged. The city had not had any military importance; not that this fact helped many other German towns...

Göttingen is a relatively small city; you can get almost everywhere by walking. The university is old, and many facilities were old-fashioned. I had to learn to appreciate the charm. The University of the Saarland, on the other hand, was founded after the Second World War, with modern buildings and equipment.



Department of Mathematics, Göttingen University.

CFS: *How many students, approximately, were there at Göttingen?*

MR: Göttingen is a relatively small town with a little more than 100,000 inhabitants at that time. I think there were around 20,000 students, probably 30,000 by now. The students really were, and still are, a very dominating section of the population. I don't know the exact numbers, but there were several hundred students of mathematics and physics.

CFS: *From what you're telling me, it would seem to be natural that tom Dieck would be your Ph.D. advisor?*

MR: In fact, I started to work under him. But then Larry Smith, a homotopy theorist at the time, was hired as a new young professor at the department. Every professor had two or three assistants, and I was offered one of these assistant positions. While I was still working on the first bits and pieces of my Ph.D. thesis, I was "taken over", so to speak, by Larry Smith, and I was his assistant for several years. And then it seemed natural to say: Since you must work with this professor, he should also be your advisor. The transition went in fact quite easy.

Also, the topic of my work shifted a bit, quite naturally so. When you work on a thesis, you start an investigation into terra incognita. Some premature ideas do not work out, and then you try something else.

In the end, my thesis dealt with the homotopy classification of liftings into fibre bundles, and more concretely, with immersions and embeddings of smooth manifolds.

CFS: *I see. You said earlier that you started being more interested in algebra, and then you switched to algebraic topology...*

MR: In my view, topology is an ideal combination of several subjects. You can't do interesting topology without knowing some algebra, some analysis, and some geometry. In the beginning I didn't think I was very good at geometrical thinking at all. I've always been very bad at drawing. I've taught myself to do drawings relevant for

mathematics, but apart from that, I have no artistic talent at all, I am afraid.

I have given a course in elementary differential geometry many times later in my teaching career. I then try to advertise the subject by telling the students that you can get to exciting results by stealing methods from analysis and linear algebra, combining them in a clever way. That synthesis has fascinated me, and I think that it made me like geometry and topology more than other mathematical areas.

### Mathematical research

CFS: *That's a nice description. Now, let us talk about your research after your Ph.D. Much of your recent research work has been about the interplay between what is called directed homotopy in algebraic topology and concurrency, a notion appearing in theoretical computer science. Could you please explain?*

MR: Let me tell you about the next steps in my career first. As a Ph.D. student, I had the opportunity to study a year in Paris. While staying at the Cité universitaire, I got to know a Danish girl who later became my wife. Consequently, I had to learn Danish, and I moved from Göttingen to Denmark. I had short term positions at the Technical University in Lyngby, close to Copenhagen with Vagn Lundsgaard Hansen, and then in Aarhus with Ib Madsen, the grand old man in Danish topology. From there I applied, and finally got, a position as associate professor at Aalborg University Center – as it was then called – in the North of Jutland, the Danish peninsula.

When I arrived, I was the only topologist at the department. I went regularly to seminars at Aarhus University and considered that as my research lifeline. I had to teach a lot, three small kids required attention, and time for research – at that time in equivariant algebraic topology – was scarce. A few years later, I was joined at the department by my good colleague and friend Lisbeth Fajstrup, a student of Ib Madsen.

Still, we felt a bit lonely research-wise and, encouraged by colleagues, we started to think about investigating applied areas of topology. An opportunity, a wild card, arose when we heard about a conference on New Connections between Mathematics and Computer Science at the Isaac Newton Institute in Cambridge, UK. We applied and were accepted. There were many interesting talks given during that week. Among them were two lectures that thrilled me from the very beginning: One outlining connections between what's called distributed computing and topology, and the other about connections between concurrency and topology; as it turns out, both are related to each other.

Let me tell you about concurrency and topology: It becomes interesting when you don't have just one program running on one processor, but when things get distributed, the latter being

more and more the case. You want to do a calculation, or to run through an algorithm, and you distribute it either on various entities on your own laptop, or perhaps even on the entire World Wide Web. Anyway, there are several units that collaborate to arrive at a solution. In the extreme case, there is no coordination or very little coordination among them. In order to rely on a result of such a common effort with very little coordination, you need to have algorithms that are robust in the following sense: It should not play a role whether one processor achieves its goal very quickly, whereas another one is slowed down for some reason. If they communicate through some common registers, the order of access may be crucial, on the other hand.

For an easy case, consider three processors, each working on a linear code without loops and branches. You can then interpret the compound process as a path in 3-dimensional space. But not every path can occur: Time has an orientation, and therefore these paths will be weakly increasing coordinate-wise; a little bit like in relativity theory. Moreover, there are regions in this 3-dimensional state space that are forbidden, due to coordination constraints: Only one, or at most a limited number of processors can access the same piece of memory at the same time.

More abstractly, we want to study directed paths in a "space with holes", often modelled as a cubical complex. Combined with a language, these are called Higher Dimensional Automata. It turns out that directed paths that are homotopic to each other, in a directed manner, describe equivalent compound processes, always yielding the same result for a distributed algorithm. A directed homotopy between directed paths, and more generally between directed maps, is a one-parameter deformation where all intermediate steps are directed as well.

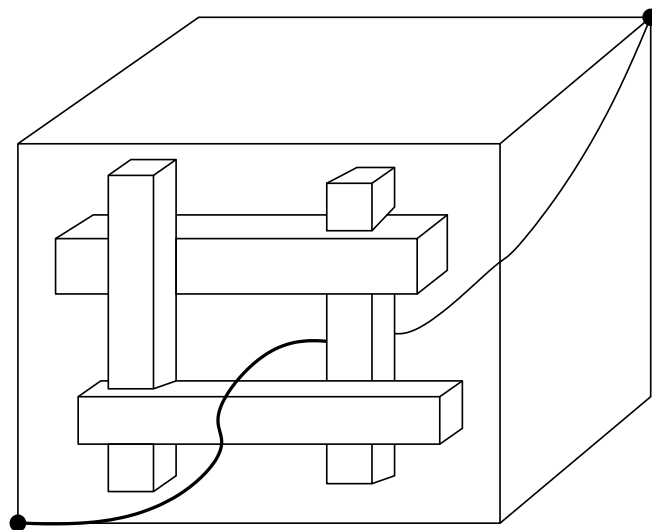

Directed path in a cube with obstructions. This path is homotopic to a directed path on the boundary of the cube, but not through any directed homotopy.



Directedness is the essence and the challenge. You cannot apply standard techniques from algebraic topology right away. We found examples of directed paths that are homotopic in the standard sense, but not so when you require directedness for all intermediate paths. In the end, you want to describe and structure the space of all directed maps up to directed homotopy, and to calculate it algorithmically.

CFS: *Have people in theoretical computer science found an interest in your approach?*

MR: Some have, and one of our first foundational papers still receives citations on a regular basis. But let me admit that there is a larger community in computer science working on coordination problems and algorithms using so-called Petri nets, an area that I do not know a lot about. Many of their and our results resemble each other. In fact, a Dutch collaborator of ours, Rob van Glabbeek, now in Scotland after many years in Australia, has shown in an abstract way that Higher Dimensional Automata are at least as expressive as Petri nets: all that they can model, we can as well.... But we are a small community compared to others.

I would like to add that we consider ourselves as a branch of the rapidly developing area *applied topology*, with topological data analysis as the most important and popular family member.

### Abel Prize interviews

CFS: *This is all very exciting. Now we are going to switch topics entirely. As you mentioned, you wound up as associate professor and then professor with special responsibilities at Aalborg University. You have been heavily involved with teaching, and you have worked as a supervisor for many students in a wide variety of mathematical topics. You also became Teacher of the year in 2018 and 2019.*

*Besides all that, you have been involved with public outreach, having given public lectures on several aspects of mathematics. Raising public awareness of mathematics is not a mere slogan for you. You have taken it very seriously. And as one of the editors, and editor-in-chief from 2002 to 2003 of the newsletter Matilde of the Danish Mathematical Society, you published interviews with various mathematicians, which made you eminently prepared to take the initiative for the interviews of the Abel Prize laureates. Could you please talk about how the interviews with the prize laureates came about?*

MR: Matilde was the journal of the Danish Mathematical Society. It was founded while Bodil Branner was the chairman of the Danish Mathematical Society, which this year is celebrating



Final issue of Matilde, 2023.

150 years of its existence. One of her many initiatives was to establish a regular newsletter. By the way, I came up with its name, Matilde: Mat (matematik in Danish comes without an h) with a tilde!

I became part of the team of newsletter editors, and my task was to interview some of the “grand old men” in Danish mathematics, for example Ebbe Thue Poulsen from Aarhus and Bent Fuglede from Copenhagen. A special treat was an interview with Ib Madsen shortly before his 60th anniversary.

Concerning the Abel Prize, Matilde’s editorial board was contacted by the embassy of Norway in Denmark: Would we be interested in covering the first Abel Prize ceremony in Oslo? I discussed the option with Mikael Rørdam, who was the editor-in-chief at the time. I gathered all my courage and suggested that we should ask for an interview with Jean-Pierre Serre, the first recipient of the Abel Prize.

CFS: *That was in 2003?*

MR: Either in late 2002 or in early 2003. We wrote back to the embassy, and they contacted the Abel committee. The committee was positive and informed professor Serre. Your colleague Kristian Seip must have heard about the initiative...

CFS: *He was the chairman of the Norwegian Mathematical Society at the time...*

MR: And he thought that it was a pity that the Norwegians had not asked for that opportunity themselves. I do not know whether he asked you first...

CFS: *He asked me first, I think.*

MR: OK, he suggested that you were involved, as well. I do not remember the details, but the two of us were put in contact. We did not know each other personally at the time. I had participated in the 20th Nordic Congress of Mathematicians in Trondheim in 1988 that you were involved in, but I do not think we made contact then.

Anyway, we teamed up, and that turned out to be a very good idea. First of all, it made me feel more relaxed, and in the long run, we became a “dream team”, right? We brought different angles to the interviews, complementing each other. We coordinated the questions we wanted to ask, the last time being in the evening before the interview took place.

CFS: *In fact, you taught me a lot about interview techniques. I learnt a lot from you.*

MR: Thanks! But you always came up with a lot of interesting questions and citations yourself. I still remember how nervous we were when we started the first interview with Jean-Pierre Serre.

CFS: *And he was not in a good mood initially!*

MR: He was not, and I kind of understand why: The Abel Prize recipients have all been quite old so far. During the week of festivities, they have a strenuous program. They are asked to attend a lot of meetings, ceremonies, they must give talks, and then one or several interviews! I do not know, but I imagine that Serre thought: “Another interview with silly journalists asking me silly questions.”

CFS: *That’s right. But let me tell you, the real breakthrough came when you told him that you were aware how he discovered some very important notion having something to do with fibre bundles. Then he lit up immediately. “Oh, you knew about that?”, he said, and that changed the atmosphere. He became very positive from then on.*

MR: Mentioning the path fibration changed the game. I re-read the interview this morning, and it is, in fact, still very interesting!

CFS: *We should not underestimate the importance of the initiative of yours getting started with the Abel interviews. The two of us went on and conducted the Abel interviews for 14 consecutive years. Then I continued together with Bjørn Dundas. I would say unabashedly that the Abel interviews are very important and successful. They are published both in the European Mathemat-*

*ical Society Newsletter, now Magazine, and in the AMS Notices. Besides, the European Mathematical Society’s publishing house, EMS Press, published a book with the interviews the two of us had.*

MR: I am also happy having been a part of that enterprise. In the end, looking back at my career, that may have been the most important thing I have been dealing with!



Abel interview 2016: Sir Andrew J. Wiles, Martin Raussen, Christian F. Skau. (Photo: Eirik F. Baardsen, DNVA.)

CFS: *To make the Abel Prize known for the maths community and beyond, these interviews have been very important, I think it is fair to say that!*

*Could I ask you, and this is a very difficult question: Do you have some special highlights that you would mention from all these interviews?*

MR: Let me try. I have two different answers to your question, on very different levels, though. The first answer is related to the amount of the Abel Prize.

CFS: *By the way, the prize money was almost one million US dollars.*

MR: Right. Often, we did not dare to ask what the recipients would do with the prize money, because that is quite personal. But I remember that we listened in on the interview conducted by a journalist with professor Serre. This journalist was less shy and asked Serre directly what he would use the prize money for. His answer was just laconic: “Well, I’ll see to have it spent.”

Another occasion that I remember vividly, occurred when we interviewed Pierre Deligne, ten years after Serre. He had made it already public, and he also told us at the beginning of the in-

terview, that this was not money for him, but it was money for mathematics. He wanted to give it to various institutions that had played an important role in his own career: the research institute IHÉS in Bures-sur-Yvette in the suburbs of Paris, and the IAS in Princeton, USA. But also to two institutions in Russia, the Department of Mathematics of the Higher School of Economics, and to the Russian Dynasty Foundation, which supported science. Deligne was clearly one of the most modest interview subjects we had.

My second answer to your question is related to reactions of our interviewees to one of our standard questions: Did some of their great results rely on sudden flashes of insight, at least partially? We have all heard the story, published in a book by Hadamard, of Henri Poincaré who while stepping into a bus somewhere in Northern France, in a sudden flash of insight saw connections between modular forms, Fuchsian functions and so on, and formalisms in non-Euclidean geometry on the other side. This has become an iconic story, an incident where a new connection suddenly pops up after the sub-consciousness has worked on it for some time. Stories of that kind have fascinated me.

Getting back to the interview with Serre: Around 1950 he worked on homotopy groups of spheres, and he established many of their properties. One of the techniques applied in the investigations makes use of the path fibration. It relates the homotopy groups of a space with the homotopy groups of its loop space. You can explain it – if you know about it – to a student who knows some elementary homotopy theory in a few minutes. But that relationship had not yet been established, before Serre.

Other far more subtle techniques, for example, spectral sequences (mainly developed by Leray for other purposes), were known and applied by Serre. Moreover, he made calculations one prime at a time, so to speak. Anyway, the path fibration was apparently a missing link that occurred to him on the night train when returning from vacations. He got so excited that he woke up his wife to tell her!

John Tate told us that when he had worked hard on the determination of higher-dimensional cohomology groups in class field theory, he went to a party and had a few drinks, came home and suddenly saw the solution after midnight. I got jealous when I heard that!

But everybody we asked told us that this happened very rarely, perhaps twice or three times in a lifetime. Moreover, they told us that such nice experiences never come for free!

They may occur after a long time and many efforts trying to put things together. Only when you have made these efforts and perhaps feel that you run against the wall, emotions come into the picture, and then your sub-consciousness might do part of the work for you. I remember very well one word that I will never forget: When discussing that same question with the late Abel Prize laureate Nirenberg, he coined it succinctly with a word in my native German: It needs "Sitzfleisch" (seat flesh) – expressing

persistence in a very physical manner – to get to anything serious. That is a story that I also like to tell my students!

CFS: *This reminds me of the following story about Niels Henrik Abel: He visited Berlin and stayed with some Norwegian friends at a shared flat. One of these friends wrote later that Abel would often wake up in the middle of the night, light a candle, and scribble down some mathematical ideas that had occurred to him during his sleep. I would certainly have appreciated it if that had ever happened to me!*

MR: So would I!

### **Activities in the European Mathematical Society**

CFS: *At the time the first Abel Prize interview was taken you were headhunted to the Newsletter of the European Mathematical Society (EMS), where you were editor-in-chief from 2003 to 2008. And in 2009, you were voted into the EMS executive committee (EC), where you participated from 2009 to 2016, the last six years as Vice President. You were liaison for the EMS committee Raising Public Awareness, and you were also the person in charge of the EMS web profile. All these are heavy and time-consuming duties. You were still teaching, and you didn't get much credit as pertains to your teaching load. Could you comment on this period of your life?*

MR: It was a challenging period that did consume quite a lot of my time, which was "stolen" from my research and from my family, I must admit. But on the other hand, I liked these duties, as well. I could utilize other facets of my personality, of my capabilities. And when I left the executive board of the EMS, I missed it for a while. It had almost become a second family for me. Most of my colleagues at the EMS are highly devoted. When they take on a job, they really do so reliably. I felt that we were pulling on the same string.

You see, the EMS is still a relatively new society. It was founded in 1990, a newcomer in comparison with the Norwegian or the Danish societies. It has almost all European mathematical societies as members, but there are still all too few individual members, only a bit more than 3000. Since I started, membership has risen from 2000 to 3000, but it's still not living up to its potential within all of Europe!

At the board meetings, discussions and decisions have to be taken all the time. For example, how is the money spent? Not that the EMS has a lot of money, but it can give something to organizations or to conferences, workshops and so on. How are you going to find out who is worth giving the money to? I was a member of the society's meetings committee preparing some of these decisions. By the way, the EMS executive committee nomin-

ates some of the members of the Abel Committee that selects the Abel Prize winners.

But probably it is more important to develop contacts with some of the politicians, speaking about the importance of mathematics towards Brussels, towards the people who really can give substantial support. That's a tough challenge. I've not really been much involved in this task. That was the challenge of the presidents of the EMS. They have done tremendous work in that direction, sometimes with success. But of course, you could always hope for much more.

I think it's really important that we have such a transnational mathematical society. Local issues can be handled much better by a national mathematical society. But it's also important to have a player on the transnational scene, to promote and to get inspiration from each other, and also to have a counterweight to the American Mathematical Society. I do not want to be negative about the American Mathematical Society at all, but it is such a dominating society, mainly for good. On the other hand, if you didn't have a competitor with the same goals, they would take over everything. A concrete instance is the database MathSciNet, a highly valuable tool. It is very important that we also have Zentralblatt/zbMATH, because otherwise there would only be one venue, and you know, when there is no competition... The EMS is one of the owners of Zentralblatt, and there is now free access!

*CFS: How many members are there in the American Mathematical Society?*

MR: I would say around 30,000. And of course, I'm also a member of the AMS, and most European mathematicians are, but too few are members of the EMS, I would say.

*CFS: I observed that there were disappointingly few members at my department in Trondheim.*

MR: Perhaps some of the readers of this interview get the idea. It's in fact cheap to become a member!

### *Raising awareness of mathematics*

*CFS: I already mentioned that you have been a spokesperson for raising awareness of mathematics. Why is that an important endeavour?*

MR: Well, for several years, from 2003 to 2008, I was the editor-in-chief of the Newsletter of the EMS. That newsletter was mainly read by mathematicians. I think that also our colleagues need good stories about successes in their own discipline!

When it comes to communicating the importance of mathematics to laymen and non-mathematicians, a lot of good work has been

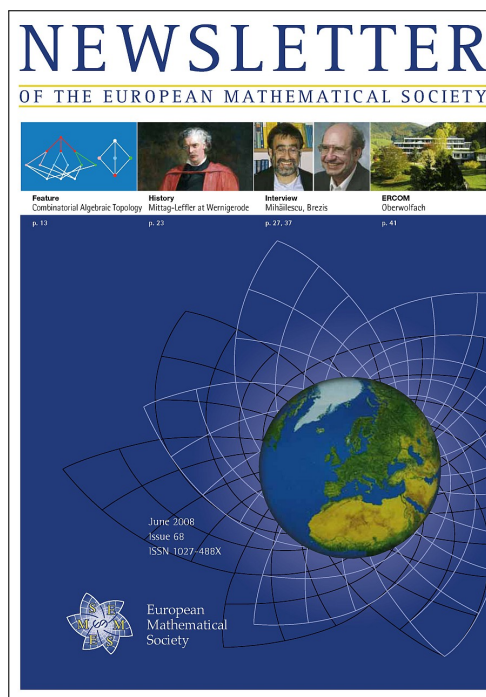

Newsletter of the EMS, 68/2008.

done by the Raising Public Awareness Committee (RPA) of the EMS. Over the years, RPA was headed by Vagn Lundsgaard Hansen from Denmark, Ehrhard Behrends from Germany, and Roberto Natalini from Italy. Members of that committee write popular books, coordinate web events, and perform "Mathematics in the Street" events on several occasions. While I was on the executive committee (EC) of the EMS, I had the role of liaison officer linking the EC with the RPA Committee, and I participated in several of its meetings. I am impressed with the work they did, and do, but I have not been very active in that direction myself.

Generally speaking, promoting mathematics seems to be more demanding than doing it for many other disciplines. One reason is arguably that mathematics is a subject that everybody has been in touch with at school, from grade one on. Hence, many people think they somehow know what mathematics is about. Depending on the level of their education, they might connect mathematics with calculations involving large numbers or evaluation of difficult integrals.

Quite few people are aware of the fact that mathematics is much more far-reaching, consisting of many subdisciplines and having so many facets. It has its own touch of beauty, it has philosophical components, and, on the other hand, it has become increasingly important in technological developments underpinning everyday life.

In comparison, physicists or computer scientists have an advantage: Their subjects are taught to a much lesser extent in school, and people realize that it is worthwhile to know more. Moreover, it is

easier for them to come up with compelling pictures, for example those from the Hubble or the James Webb telescopes showing us the universe in its splendour. That does not mean that a layman like me fully understands modern physical theories, but these pictures fill you with awe. It is not that mathematicians do not try to do something similar: There are lots of beautiful and impressive pictures available on various platforms, like for example IMAGINARY<sup>2</sup>. But it is more difficult to demonstrate to the uninitiated that coding theory or topological data analysis are built on beautiful insights with tremendous applications.

CFS: *I think this is a very important point.*

MR: So, let us welcome every initiative to build bridges! My own contribution has been directed to the mathematical community. The Abel Prize interview conveyed essential points of view of extraordinary mathematicians.

As a teacher, I try not only to talk about interesting and important mathematical concepts, results, and techniques, but also to put things into perspective. What is the reason for studying a particular topic? Why is this result a small technical lemma, and why is another one an important theorem? For example, why is Gauss' Theorema Egregium really "egregium"?

CFS: *It is really depressing that many people are almost proud of admitting that they are illiterate in mathematics, or that they even hate mathematics! Take for example Aftenposten, the largest Norwegian newspaper, which is supposed to have a cultural dimension as well. Nevertheless, they hardly mention the Abel Prize at all. In the twenty years of the existence of the prize, very few articles have appeared about the Abel Prize and its recipients. Without any shame, they have neglected it over many years!*

MR: We have also had great difficulties to advertise our Nordic Congress in the press. The local newspaper that often boasts of minor local initiatives neglects the congress. The only laudable exception is the newsletter Ingeniøren, published by the trade union of Danish engineers.

### **Beauty and importance of mathematics**

CFS: *In this connection, I would like to read an excerpt from the eulogy that the brilliant Norwegian mathematician Ludvig Sylow wrote in 1899 on the occasion of Sophus Lie's death: "It is the mathematician's misfortune more than the other scientists that his work cannot be presented or interpreted even for the educated general public. In fact, hardly to a collection of scientists from other fields. One has to be a mathematician to appreciate the beauty of*

*a proof of a major theorem, or to admire the edifice erected by mathematicians over thousands of years." Any comments?*

MR: Well, to assess that something is exceptionally beautiful, you need to have certain background knowledge. But this is also true for advanced music or painting. I think, though, that it is easier for artists to get us emotionally involved. It is far more difficult to achieve this when talking about mathematical ideas and methods. People have tried to find different ways to do that. It is a challenge for the entire community.

CFS: *That reminds me of a statement by one of the Abel Prize recipients, the late John Tate, who stated during our interview: "Mathematics is both art and science. There are artistic aspects to mathematics. It is just beautiful. Unfortunately, it is only beautiful to the initiated, to the people who do it. It can't really be understood or appreciated much on a popular level the way music can. You do not have to be a composer to enjoy music, but in mathematics you have to be a mathematician to appreciate it." Another Abel Prize recipient, László Lovász, lamented that science in general is in danger. Things have become so complicated that it is very difficult to distinguish between science and pseudoscience. Mathematicians, and scientists at large, have a responsibility for making the public aware of this danger, which has wide implications.*

MR: That is already a challenge at school!

CFS: *Lovász thinks that we do not teach mathematics the right way in high school, at least seen from his Hungarian perspective. We do not give pupils enough safeguards against pseudoscience and unscientific speculation.*

MR: Hard to disagree! But not everything is bad: For centuries, mathematics had little influence on technology, on real life. Of course, there are examples to the contrary, land surveying in Egypt and ancient astronomy, for example. But the applicability of mathematics has exploded, especially in our lifetime. Mathematics is no longer only essential for physics and engineering, mathematics is everywhere! It has become an economic pillar of society, underpinning important industry sectors, going hand in hand with engineering and computer science. Many consumer goods, modern cars, planes are inconceivable without the input of mathematics. Just think about our means of communication, and credit cards, GPS, as well. Mathematical modelling makes reliable predictions possible. No data science without mathematics!

Number theory was completely estranged from applications, as Hardy proudly noted less than a century ago. Now sophisticated number theory, deep results on elliptic curves, are quintessential in coding and cryptography. But unfortunately, the mathematical community has not been good enough to communicate the beauty and the practical importance of our subject.

<sup>2</sup> <https://www.imaginary.org>

CFS: *Tell us about the quote from René Thom that you mentioned prior to this interview!*

MR: I told you earlier that I spent a year in Paris as a Ph.D. student. I went regularly to the IHÉS at Bures-sur-Yvette. At that time René Thom was still around, probably as an emeritus professor. He was a demigod in my eyes; he had developed so many important parts of differential and algebraic topology. At that time, his catastrophe theory was still a hot topic. Thom had by then acquired a deep interest in the history of mathematics. On Saturdays, when the institute otherwise was quite calm, he ran a seminar on the history of mathematics, with varying lecturers. I went there several times. During one of the sessions, he said (slightly paraphrased): “I was told that more than half of the mathematicians throughout history are still alive. But that is certainly not the better half!”

CFS: *I like that quote! Now a quote from Harish-Chandra: “I have often pondered over the roles of knowledge or experience on the one hand, and imagination or intuition on the other, in the process of discovery. I believe that there is a certain fundamental conflict between the two. And knowledge, by advocating caution, tends to inhibit the flight of imagination. Therefore, a certain naïveté, unburdened by conventional wisdom, can sometimes be a positive asset.” Do you have comments?*

MR: It is certainly true that the most stunning results of the Abel Prize recipients that we interviewed go back to their young age, when they were around thirty years old, or younger. In that sense Harish-Chandra seems to be right. Our interviewees told us that when they got older, they knew the literature better and also how to avoid possible pitfalls. But some naïveté is needed, as well as brute force, to start on a mathematical endeavour, thinking: “Perhaps I can do something here where nobody else so far has been successful.”

At a higher age, these top mathematicians are of course still enormously talented. They would build on previous experiences, on their contact network, and advance the subject by sharing ideas with others. But the naïve courage to start on a new undeveloped area with brute force is rather something for talented young less experienced people.

CFS: *This brings us again to Hardy’s “Mathematics is a young man’s game”, that you just explained very eloquently. And still, you need “Sitzfleisch”!*

### **Computer aided mathematics**

*Now to a hard question: If you should venture a guess, which mathematical areas do you think are going to witness the most important developments in the coming years?*

MR: That sounds like a question for people from the Champions League, and not to me.

CFS: *Let me give you a clue: Could it be that using computers will have some effect?*

MR: Well, they have already had a certain effect. I mean, it started with the solution of the four-colour problem back in the late seventies. And it happens more and more often that results are checked with computer aid. And there are new developments. Already several years ago the proof of the Feit–Thompson theorem about the solvability of groups of odd order was checked by computer, and that proof fills a 250 pages journal paper. I’ve heard by hearsay that the proof of an important step in the new discipline of condensed mathematics advanced by Dustin Clausen and Peter Scholze needed to be checked by computer; this was done successfully in an effort that applied the proof assistant system Lean.

I imagine that future mathematicians will get a lot of help from advanced artificial intelligence. Already now you can ask whether there exist results in a certain direction. And then the entire existing literature will be searched. If you ask intelligently enough, then you will either find an answer, or a “no”. I guess that you can progressively enter a dialogue with computers, adding two forces: human imagination on the one hand, and the enormous power of computer algorithms searching through and combining everything that exists, and to do that very quickly, on the other hand. And I don’t see an end to that story.

When I was young, it was completely unimaginable to think that a computer might be better at chess or Go than a human being. But now they are!

CFS: *It’s sort of depressing in a way.*

MR: On the other hand, maybe it opens venues and options that you otherwise couldn’t be aware of.

CFS: *That is certainly true. When we interviewed Peter Lax, who is also one of the Abel Prize recipients, about how fast computers had become, he said that half the speed is due to clever algorithms. But to get clever algorithms you need mathematicians.*

MR: And the work developing these algorithms for computer aided mathematics demands mathematicians at a high level.

### **Frogs and birds**

CFS: *Now to a quotation from Felix Klein. He said that mathematics develops as old results are being understood and illuminated by new methods and insights. Proportionally with a better and deeper understanding, new problems naturally arise. Your comments?*

MR: I remember we asked some of the Abel Prize recipients about that. One might be afraid that at a certain point everything that is worth developing in mathematics has already been done. How could a young person then find something worthwhile to think about? But I think it was Serre who said something like: "I don't worry about that. New problems do arise all the time." Look at what happened during our lifetimes: So many new subjects in mathematics that almost didn't exist when we started, are flourishing now. Others, that were very much the talk of the day do still exist, but not with the same attention. I think it's particularly young people who can somehow sense in which directions new things happen, and then they dive into these and give them a push.

CFS: *Hilbert said that problems are the lifeblood of mathematics. No question about that.*

MR: I remember that we received different answers to the question, whether our interviewees regarded themselves mainly as theory builders or as problem solvers. You have these two capacities within one person, but more widely, also in the mathematical community. It is very important that both types of mathematical preferences coexist, and that they can profit from each other.

CFS: *You gave me the clue to another quotation, this time from Freeman Dyson. I think he describes "theorem builder" versus "problem solver" very well: "Some mathematicians are birds, others are frogs. Birds fly high in the air and survey broad vistas of mathematics, out to the horizon. They delight in concepts that unify our thinking and bring together diverse problems from different parts of the landscape. Frogs lie in the mud below and see only the flowers that grow nearby. They delight in the details of a particular object, and they solve problems one at a time." I think that's a very nice description.*

MR: I think it's almost impossible to say that in a better way. It's important that the frogs and the birds coexist.

CFS: *I agree with you. I think it was Andrew Wiles who told us in the interview: "The definition of a good mathematical problem is the mathematics it generates, rather than the problem itself."*

MR: That's well said. And there are many instances where you can show that this is true. Take the Fermat conjecture as an example. Due to Wiles, we know that it is true. But the whole build-up leading to the final solution is so much more important than the result itself. It has given insights that Fermat could not even have dreamt of.

CFS: *Perhaps it is relevant here to mention, as we did in the interview with Atiyah and Singer, Eugene Wigner's statement about*

*the unreasonable effectiveness of mathematics in the physical sciences, as well as Galileo's dictum, that the laws of nature are written in the language of mathematics.*

### **Private interests**

*Let us end this interview with a question that you also suggested including in the Abel interviews: What interests do you have outside of mathematics?*

MR: My answer to that question might be a little disappointing. Of course, I must think about that now because I'm going to retire, and that means that mathematics will play a minor role in my life in the future. Hobbies will have to take over more time. I would have difficulties to single out a specific hobby and say: "Now I know exactly what I will spend my time on." In a more positive way, and certainly exaggerating, I would say I'm a renaissance man in the sense that I have many things that I'm interested in.

I like to read popular science books, and I hope to get more time to do that. Biology, genetics, evolution, climate, so many new things happen. I have often looked avidly into the leaflets from an institution called People's University and told myself: "Okay, you could do this, and you could do that if you just had the time." Now I will get more time to spend on these interests.

Moreover, I like listening to and learning about music, both classical music and jazz. If it were not for this congress, I would have gone to many events at the Copenhagen Jazz Week, which is going on in this same week. I'm now living most of the time in the Copenhagen area, and I take the opportunity to go to classical concerts by the Radio Symphony Orchestra and the like from time to time. I also like to visit art exhibitions. Perhaps I might play a bit more the piano as I did as a teenager, but not systematically ever since. Last but not least, more time for my family!

CFS: *Thank you very much on behalf of myself and of the Norwegian and the Danish Mathematical Society for this very interesting interview. It's been a pleasure.*

MR: It has been my pleasure as well. And I'm thrilled and thankful that you took the effort to come to Aalborg just to interview an ordinary mathematician like me.

—

Christian F. Skau is a professor emeritus of mathematics at the Norwegian University of Science and Technology (NTNU) at Trondheim. His research interests are within  $C^*$ -algebras and their interplay with symbolic dynamical systems. He is also keenly interested in Abel's mathematical works, having published several papers on this subject.

[csk@math.ntnu.no](mailto:csk@math.ntnu.no)

# Aspects of the gender gap in mathematics

Sophie Dabo-Niang, Maria J. Esteban, Colette Guillopé and Marie-Françoise Roy

## Introduction

As a contribution to some aspects of the gender gap in mathematics, this paper provides a detailed analysis of mathematicians' answers to the Global Survey of Scientists [6]. The questions we address are the following: are the answers from all sciences and the answers of mathematics or applied mathematics similar? In which cases is the situation in mathematics or in applied mathematics different from the situation in all sciences? Better or worse?

The Global Survey of Scientists [6], a survey of scientists from every continent, was launched to assess and understand the gender gap in science as part of the project "A Global Approach to the Gender Gap in Mathematical, Computing, and Natural Sciences: How to Measure It, How to Reduce It?", in short "Gender Gap in Science," funded primarily by the International Science Council from 2017 to 2019.<sup>1</sup> The Global Survey of Scientists assesses female and male scientists' experiences throughout their careers. More precisely, the survey reveals how scientists perceived their education, university studies, doctoral studies, career, the balance of their work and family life, and whether they experienced discrimination or sexual harassment.

The Global Survey of Scientists was distributed in Arabic, Chinese, English, French, Japanese, Russian, and Spanish. More than 30,000 people, half of them men and half women, responded to the questionnaire, mainly from the disciplines involved in the project: mathematics including applied mathematics, computer science, biology, chemistry, physics, astronomy, history and philosophy of science.

Overall, the survey findings confirm the existence of a significant gender gap in the scientific community. In all areas explored by this survey, women's experience is consistently less positive than that of men.

It is important to highlight the methodology used to collect the data. As there is no single network or resource for contacting all students and professional scientists worldwide, a *snowball* sampling method was used to tap into as many personal net-

works as possible. The contact databases of the project's partner organisations were used to reach students and professional scientists worldwide, asking them to complete the survey and invite their contacts to respond. *Snowball* sampling does not produce a statistically representative sample. For example, women account for around 30% of scientists worldwide [13], but 50% of survey responses came from women. Consequently, our findings only indicate trends among those who responded to the survey, not the overall population of scientists. However, the consistency of the results across disciplines, geographical areas and levels of development is reassuring.

Following the completion of the Global Survey of Scientists and the publication of its results, it was decided to further exploit the data concerning mathematicians' responses to the survey and compare them to the responses from all sciences. Our aim was to see if there were differences between mathematicians and other scientists in terms of the gender gap. The answers of the 3,458 mathematicians (among them 2,146 applied mathematicians) who responded to the survey were then analysed and compared to the 30,037 answers to the questionnaire. In an internship funded by the IMU and ICIAM, Cecilia A. Rivera Martinez [12] started a statistical analysis of the corresponding data using a methodology based on a multivariate analysis to discard results due to confounding variables, as explained in the [Appendix](#). Further work was then carried out to refine and interpret her results and visualize them.

Our analysis confirms the existence of a significant gender gap in the mathematical community: in all areas explored by the Global Survey of Scientists, women mathematicians' experience is consistently less positive than that of men mathematicians. In most cases, the answers from all sciences and the answers from mathematics or applied mathematics are in fact very similar. However, in a few cases, it is possible to see that the situation in mathematics or in applied mathematics is different from the situation in all sciences, sometimes better, sometimes worse.

The paper is organised as follows. First, we examine the results of the survey in mathematics and applied mathematics. We then give some additional information about the Gender Gap in Science project and its results, in addition to the Global Survey of Scientists. We end with a conclusion.

<sup>1</sup> <https://gender-gap-in-science.org/>



# 1 The results of the Global Survey of Scientists in mathematics and applied mathematics

The questionnaire covered nine main themes: a total of 30,037 persons responded worldwide, half women and half men, mainly from disciplines involved in the project, say mathematics, including applied mathematics, computer science, biology, chemistry, physics, astronomy, history and philosophy of science. In that survey, the questions were broadly organised around nine themes: (1) secondary degree; (2) first university degree; (3) master and doctoral degree; (4) employment; (5) grants, publications, and related topics; (6) interruptions in studies and career; (7) marriage, partnership, and parenthood; (8) discouragement and discrimination (9) sexual harassment.<sup>2</sup>

## Data collected

We analyse the answers of the 3,458 mathematicians (among them 2,146 applied mathematicians) who responded to the survey and compare them to the answers from all sciences. In terms of gender distribution, we note a higher percentage of men in mathematics than in all sciences, and a higher percentage of women in applied mathematics than in all sciences (Figure 1).

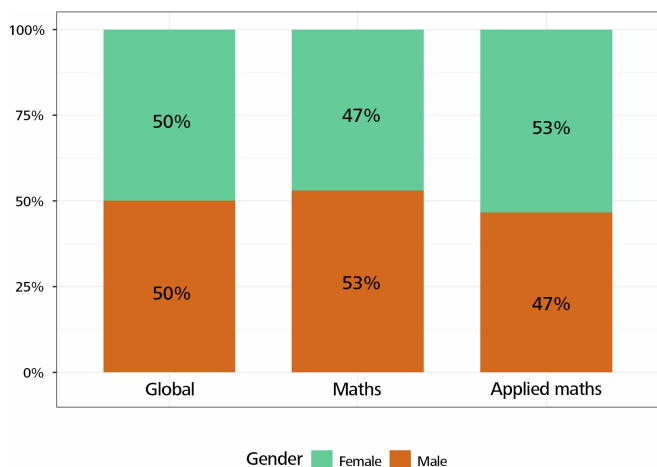

Figure 1. Answers to the question “Are you a woman/a man?”.<sup>3</sup>

We decided to organise the results in four chapters: Studies, Work, Balance of work and family life, and Difficulties.

All the statements in this text that are not illustrated by figures can be viewed on the website indicated above.<sup>4</sup> It is important to note that in all the results we present to illustrate a difference between the answers of women and men, our multivariate analysis confirmed that the difference is not due to confounding variables such as age, employment sector, geographical region or HDI (Human Development Index) of the country.

## Studies

To the question “Who most encouraged you in your studies?”, the percentage of answers “your own determination, will power and hard work” is very high, and even more so for women. Similarly, parental support is very important for women. Support from teachers is also significant, and more important in mathematics than in all sciences. Teachers appear to support men more than women in applied mathematics. On the other end, there is no difference between women and men when it comes to support from teachers, professors or mentors in all sciences and mathematics (Figure 2).

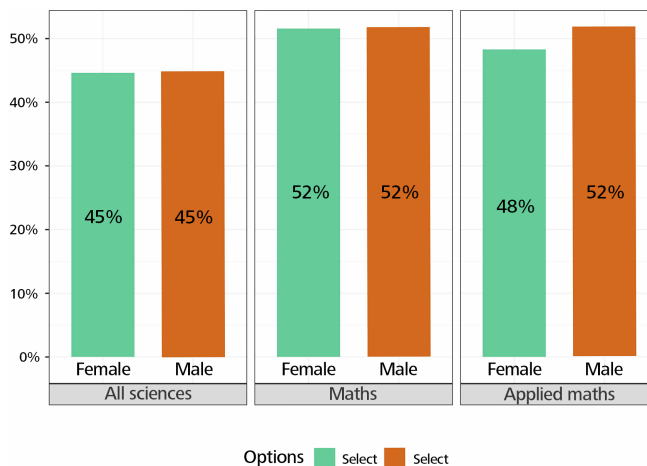

Figure 2. Answers to the multiple choice question “Who most encouraged you in your studies?”; for the option: “Teachers, professors, or mentors.”

Spouse or partner support is more important for women than for men. Support from other students or from the neighbourhood, community and friends is significantly less important for women, especially in mathematics! (Figure 3.)

To the question “How do you rate your overall experience in your doctoral program?” the answers were very positive regarding the curriculum and the quality of the program, especially in mathematics, and with no difference between women

<sup>2</sup> See the list of questions (in English) here: <http://bit.ly/GSSQuestionList>.

<sup>3</sup> There were too few answers to the third option “prefers not to answer” for them to be analysed in the statistics.

<sup>4</sup> <https://gender-gap-in-science.org/mathvisualisation/>

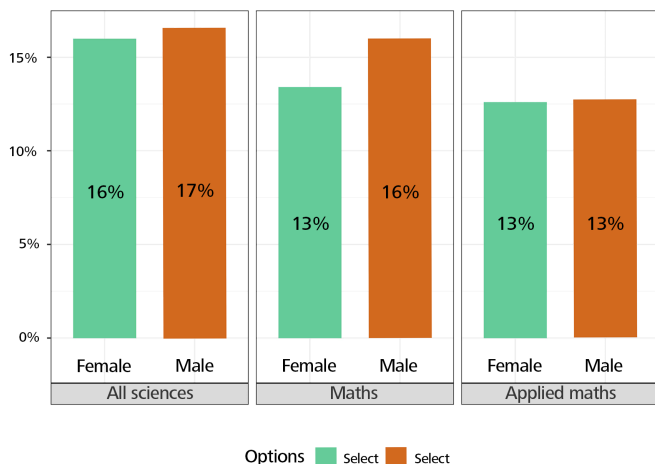

Figure 3. Answers to the multiple choice question “Who most encouraged you in your studies?”; for the option: “Other students.”

and men. The relationship with the advisor is very positive in mathematics compared to all sciences, but less positive for women than for men. For the questions “My program treated everyone fairly” and “Other students were respectful of everyone” more women disagreed. However, the answers of women are slightly more positive in mathematics than in all sciences (Figure 4).

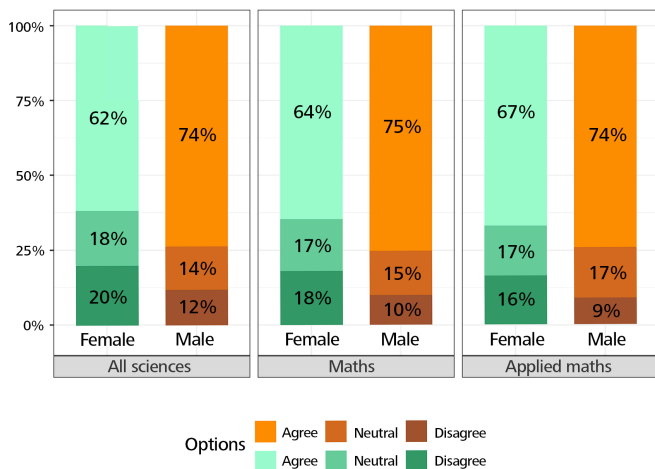

Figure 4. Answers to the statement “My program treated everyone fairly.”

There is a significant difference between women and men’s answers to the question “Was your primary advisor/supervisor a woman or a man?”. There are few women advisors, especially in mathematics. However, more women than men have female advisors.

In response to the question “During your doctoral studies, did you have enough of the following to conduct or present your research?”, a large majority are satisfied with the funding, but the percentage of women satisfied is lower. The same applies to similar questions (office space, laboratory space, equipment, travel expenses, administrative support, IT capacity, technical support, access to data, access to scientific literature). When it comes to support for working parents, women are significantly less satisfied, but the difference between women and men is smaller in mathematics.

When it comes to the answers to the question “What were the primary sources of financial support during your doctoral studies?” in mathematics, the percentage of women answering “yes” for fellowship, scholarship, or grant, is lower than that of men. In mathematics, the percentage of women answering “yes” is higher than that of men for teaching or research assistantships, in contrast to the situation in all sciences. The percentage of “yes” answers is higher for men when it comes to government income or support from parents or family, and lower overall in mathematics (Figure 5).

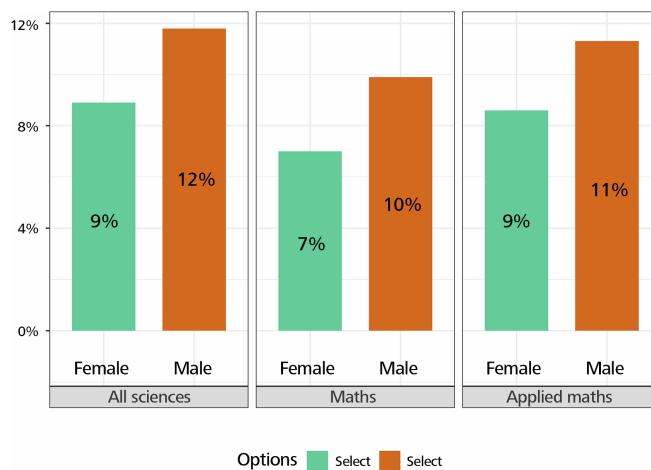
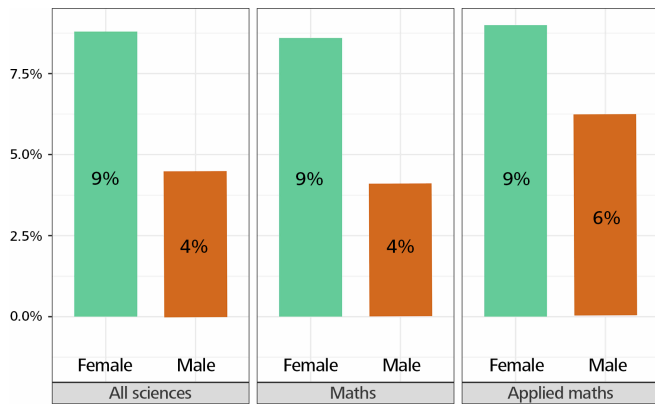

Figure 5. Answers to the multiple choice question “What were the primary sources of financial support during your doctoral studies?”; for the option: “Government income.”

The percentage of “yes” answers is higher among women when it comes to personal savings or support from a spouse or partner (Figure 6).

Women are more likely to interrupt their doctoral studies (Figure 7). The reasons for interruption, for which the percentage of women is higher, are pregnancy and/or child-rearing, but also family obligations or change of family situation, change of residence due to partner harassment or discrimination. Not surprisingly, har-



Options █ Select █ Select

Figure 6. Answers to the multiple choice question “What were the primary sources of financial support during your doctoral studies?”; for the option: “Spouse or partner.”

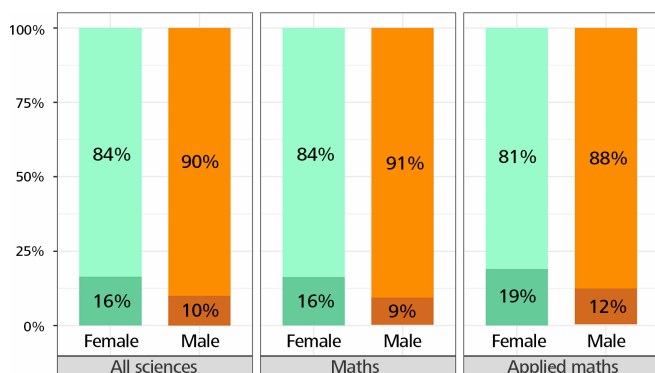

Options █ No █ Yes █ No █ Yes

Figure 7. Answers to the question “Have there been significant interruptions in your doctoral studies?”.

assessment or discrimination is mainly experienced by women, but less so in mathematics or applied mathematics.

The reasons for interruption, for which the percentage of men is higher, are military service, but also change of field of study, difficulties with the university or supervisor/advisor, or financial constraints.

### Work

More women than men disagree with the following statements: “My employer treats everyone fairly,” “My co-workers are respectful of everyone” (Figure 8), “I have support from my primary manager or boss.”

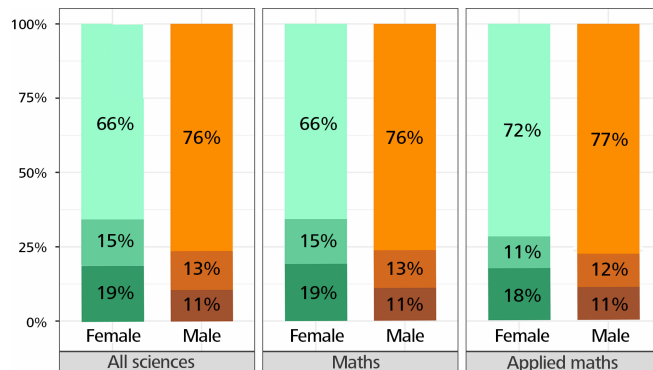

Options █ Agree █ Neutral █ Disagree █ Agree █ Neutral █ Disagree

Figure 8. Answers to the statement “My co-workers are respectful of everyone.”

When it comes to sufficient resources for research, women are consistently less satisfied than men, particularly in terms of funding, travel money and support for working parents.

It is harder for women to find jobs, progress in their careers and be well paid, compared to other colleagues with similar qualifications. Women have fewer opportunities than men to give a talk, attend a conference abroad, conduct research abroad, and to act as a boss or manager.

Opportunities to advise or supervise post-graduate students, to serve on a thesis or dissertation committees (not as advisor or supervisor) or to serve on an organising committee are lower for women than for men, particularly in the field of mathematics.

Women are less likely to be editors of journals, particularly in mathematics (Figure 9).

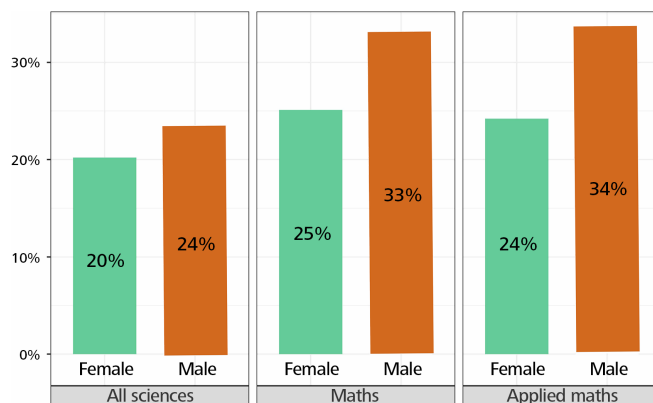

Options █ Yes █ Yes

Figure 9. Answers to the statement “Served as editors of a journal.”

The only situation where the percentage of women is slightly higher than that of men in mathematics is in lectures or interviews aimed at the general public, e.g., on television, in newspapers and magazines.

Career breaks affect women more than men. Women, more often than men, have interrupted their careers to look after their families. Career interruptions have affected the type of work they do, their professional credibility or reputation, more often for women than for men.

Women feel less comfortable than men in raising concerns with their manager (Figure 10).

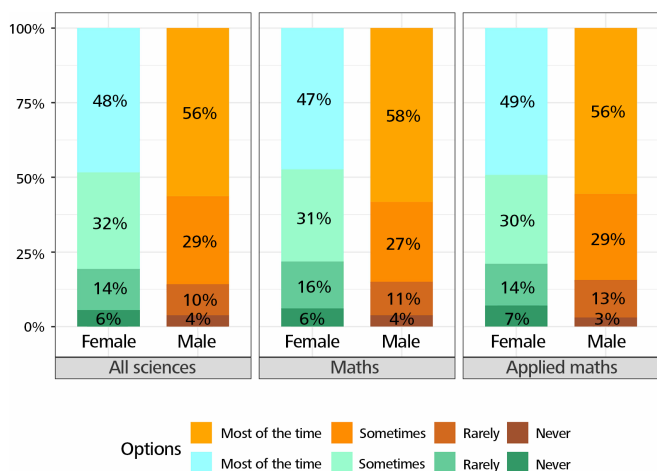

Figure 10. Answers to the statement “I generally feel comfortable in raising concerns with my primary boss, manager, or supervisor.”

Women are more often supervised by women than men in all sciences, but not in mathematics, where the proportion of women supervisors is especially low.

Women and men discuss their work or funding matters in the same way.

Women discuss their interaction with a boss or manager, their personal life, and their family obligations more than men. Men discuss their salary more than women.

### Balance of work and family life

Their career influenced their decisions to have children, to marry or enter a similar long-term partnership more often for women than for men.

The spouses of female scientists are more likely to have a high level of education than the spouses of male scientists. More male scientists’ spouses are unemployed, and more female scientists earn less than their spouses. More women than men have a partner or spouse employed in their field.

More men than women had their first child after their doctoral degree.

Maternity or paternity leave is much longer for women than for men. It should be noted that maternity leave is not universal throughout the world and paternity leave is not so common.

Changes in work and career due to parenthood are not the same for women and men. Women are more likely than men to have chosen more flexible working hours, to have spent much less time at work, and to have seen their careers or promotion rates slow significantly (Figure 11).

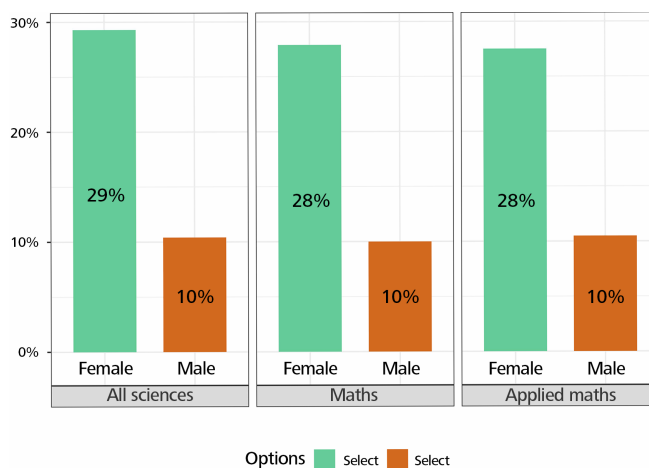

Figure 11. Answers to the statement “My career or rate of promotion slowed significantly.”

After having children, more women than men say that they have become more efficient at work.

More women than men changed employers or fields of employment or became stay-at-home parents. The answer is more often “true” for women in all sciences than for women in mathematics.

More men than women answered that there had been no significant change for them when they became a parent.

Women take care of the housekeeping much more than men do, especially in mathematics. The percentage of men thinking that household chores are distributed equally within the family is higher than the percentage of women with the same opinion, especially in mathematics (Figure 12).

Women answered more often than men that they were primarily responsible for caring for family members other than children.

### Difficulties

Women find it more difficult than men to deliver what is expected of them in their studies or careers (Figure 13).

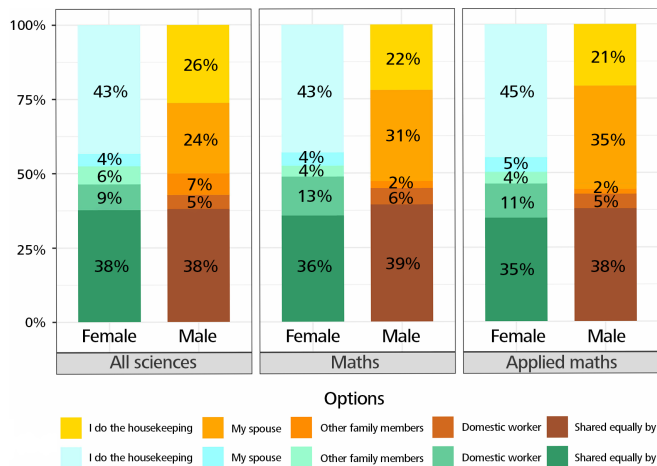

Figure 12. Answers to the question “Who is responsible for the majority of the housekeeping in your household?”.

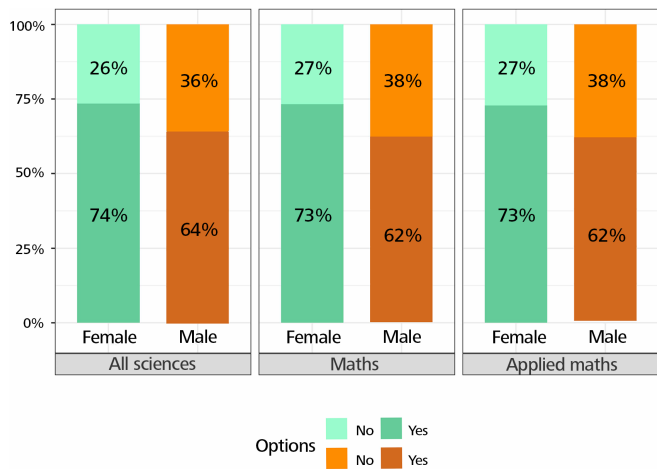

Figure 13. Answers to the question “Have you ever had a period of time during your studies or career when it was difficult for you to deliver what was expected from you?”.

Women, more often than men, cite pregnancy, raising children, caring for other family members, as the main reason for their difficulties, as well as illness, accident, or death of a close family member. Men, more than women, see divorce or the demands of work as the main reason for their difficulties.

In all the questions regarding the discouragement created by particular difficulties, there was no option where men felt more discouraged than women (see Figure 14 for the option “Interaction with colleagues”).

Men, more than women, never felt discriminated against in the assessment of their achievements (Figure 15). Women, more than men, felt discriminated against because of gender (Figure 16), age, marital status, pregnancy, or responsibilities for children.

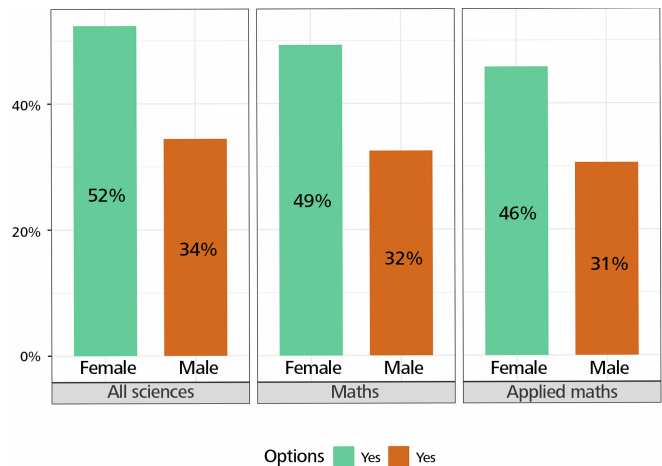

Figure 14. Answers to the question “Have you ever felt discouraged about your field for any of these reasons?”; for the option: “Interaction with colleagues.”

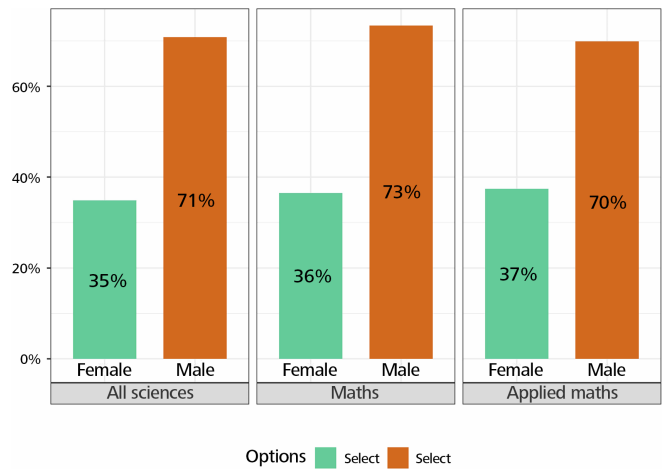

Figure 15. Answers to the statement “Never experienced discrimination.”

Men, more than women, felt discriminated against because of their social status.

The answer regarding sexual harassment at school or at work reveals a huge difference between women and men, not only in terms of personal experience, but also in terms of awareness of what happens to others. Many more men than women have never experienced sexual harassment (Figure 17).

The statement “It happened to me” is overwhelmingly more often true for women than for men (Figure 18).

Women in mathematics compared to women in all sciences were however less likely to have experienced sexual harassment and less likely to answer that it had happened to them.

The statement “I witnessed it happening to someone else” (Figure 19) or “I heard about it happening to someone else” is much

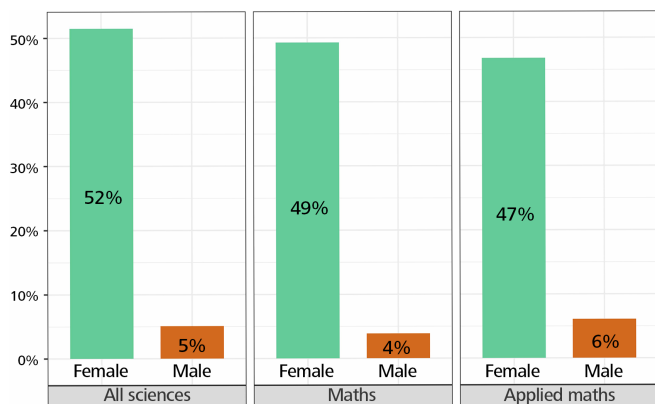

Options ■ Select ■ Select

Figure 16. Answers to the question “Have you ever felt discriminated against in the assessment of your achievements because of gender?”.

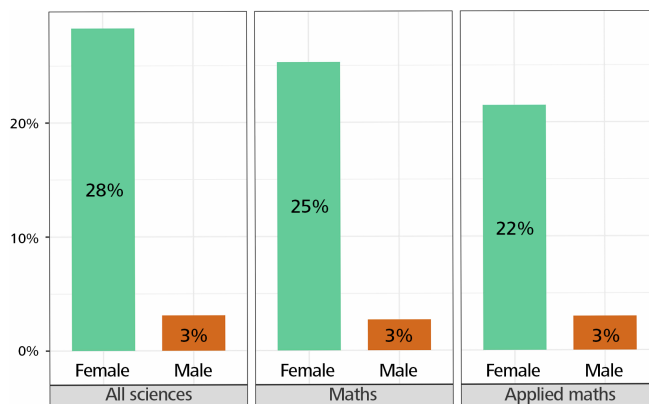

Options ■ Select ■ Select

Figure 18. Answers to the statement “It happened to me.”

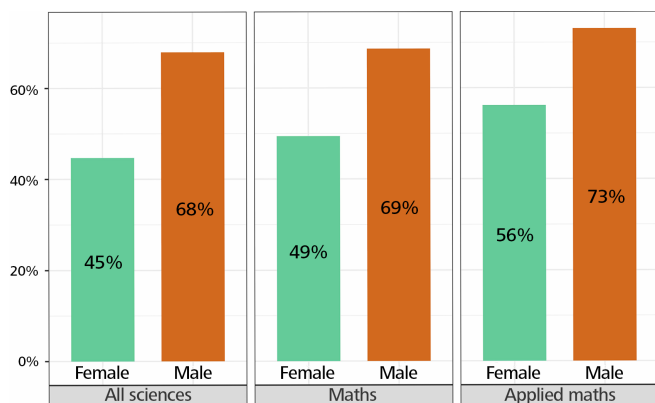

Options ■ Select ■ Select

Figure 17. Answers to the statement “Not encountered sexual harassment.”

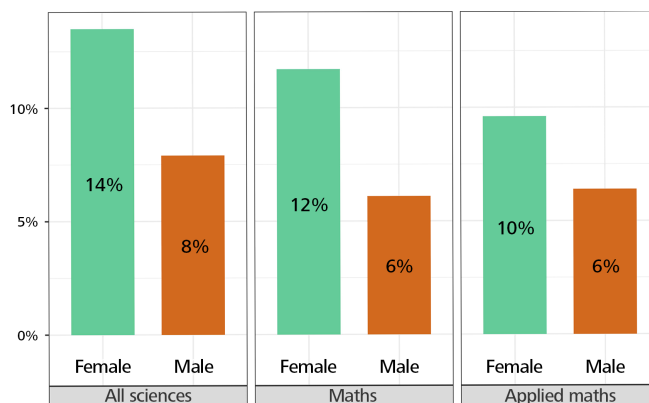

Options ■ Select ■ Select

Figure 19. Answers to the statement “I witnessed it happening to someone else.”

more often true for women than for men. For both questions, the percentage of women answering “true” is lower in mathematics or in applied mathematics compared to all sciences.

## 2 The Gender Gap in Science project and its outcomes

As already mentioned above, the project “A Global Approach to the Gender Gap in Mathematical, Computing, and Natural Sciences: How to Measure It? How to Reduce It?” was an interdisciplinary and international project funded by the International Science Council.<sup>5</sup> Led by the International Mathematical Union (IMU) and the Inter-

national Union for Pure and Applied Chemistry (IUPAC), it gathered eleven international unions and organisations.<sup>6</sup>

This project contributed to the analysis of the gender gap in science from three complementary perspectives:

- the Global Survey of Scientists [6], already discussed above;

<sup>5</sup> <https://council.science>  
<sup>6</sup> IMU; IUPAC; International Union of Pure and Applied Physics (IUPAP); International Astronomical Union (IAU); International Union of Biological Sciences (IUBS); International Council for Industrial and Applied Mathematics (ICIAM); International Union of History and Philosophy of Science and Technology (IUHPST); United Nations Educational, Scientific and Cultural Organization (UNESCO); Gender in Science, Innovation, Technology and Engineering (GenderInSITE); Organization of Women in Science for the Developing World (OWSD); Association for Computing Machinery (ACM).

- the study of publication patterns [10, 11];
- the database of good practices [8];

and has drawn up a list of recommendations.

The results of the Gender Gap in Science project were published in the Gender Gap in Science book [5].

### **Publication patterns**

Since successful academic careers are strongly linked to a prolific scholarly record, and scientific publications play a key role in scientific reputation, understanding publication practices in various disciplines is paramount to understanding the gender gap in science.

Including mathematics, astronomy, theoretical physics, and, partially, chemistry, the project analysed millions of publications from 1970 to present day. The databases zbMATH, ADS, and arXiv were chosen as data sources for their specificity and for being comprehensive.

The findings offer deep insights into the dynamics of academic publishing: the percentage of women authoring scientific papers in these disciplines has increased steadily, and the publication profiles of women and men became more and more similar. However, the percentage of women authors of articles in top journals has stagnated in mathematics and theoretical physics and remains around 10%, while it has increased in astronomy and chemistry. Female authors are less numerous in theoretical disciplines while they are more numerous in applied and collaborative fields.

A comprehensive interactive tool on publication patterns has been developed and is accessible to all.<sup>7</sup> Available free of charge online, this tool provides customized information on gender-related aspects (authors, editors, etc.) for a long list of journals.

### **Database of good practices**

A selection of initiatives aimed at reducing the gender gap in many countries and disciplines has been identified and a set of dimensions characterizing “good practices” has been applied to all these programmes to explain why they “work.” The database is available and can be enriched interactively with other initiatives.<sup>8</sup>

### **Recommendations**

Recommendations for instructors and parents, scientific organisations and scientific unions have been discussed and compiled. They are available in the booklets published in several languages as part of the project.<sup>9</sup>

### **The Standing Committee for Gender Equality in Science**

In order to promote gender equality in science, several of the international organisations involved in the “Gender Gap in Science” project, in particular IMU and ICIAM, wish to act together by continuing and expanding the work accomplished to date, in particular by supporting equal access for women and girls to science education, by promoting equal opportunity and treatment for women in their careers. To this end, they set up a Standing Committee for Gender Equality in Science (SCGES) in September 2020.<sup>10</sup> Twenty-four scientific unions are members of SCGES in February 2024. The SCGES produces an annual report<sup>11</sup> describing its activities and its members’ initiatives in favour of gender equality, and organises a series of webinars.<sup>12</sup>

## **3 Conclusion**

Gender equality, more specifically “Achiev[ing] gender equality and empower[ing] all women and girls” is one of the 17 Sustainable Development Goals adopted by the United Nations Member States in 2015.<sup>13</sup> An important gender gap remains however present in all aspects of life everywhere in the world, including, for instance, access to economical resources, political representation, child-rearing and family workload, and stress levels (see, for example, [14]). Inequalities between women and men are present everywhere, and always to the detriment of women.

In this context, it is not surprising that the gender gap is also very real in the sciences, and particularly in mathematics and applied mathematics. According to the UNESCO Institute for Statistics [13], less than 30% of the world’s researchers are women, reflecting a clear gender gap in science. There are no similar global statistics for mathematics. However, several contributions are devoted to the history and analysis of the gender gap in mathematics (see [1, 2, 4, 9] for further references). Moreover, various national or continental organisations take initiatives to reduce the gender gap in mathematics.<sup>14</sup>

The results of the Global Survey of Scientists illustrate once more the pervasiveness of the gender gap in science. They document several aspects that are not measured on bibliographic metadata, such as family support, access to resources, work-life balance, and sexual harassment.

Our analysis of the Global Survey of Scientists sheds light on many aspects of the gender gap in mathematics compared with the greater scientific community. In the vast majority of questions,

<sup>10</sup> <https://gender-equality-in-science.org>

<sup>11</sup> <https://gender-equality-in-science.org/what-does-the-scges-do/scges-annual-report/>

<sup>12</sup> <https://gender-equality-in-science.org/scges-webinar-series/>

<sup>13</sup> <https://www.un.org/sustainabledevelopment/development-agenda/>

<sup>14</sup> <https://www.mathunion.org/cwm>

<sup>7</sup> <https://gender-publication-gap.f4.htw-berlin.de>

<sup>8</sup> <https://www.mathunion.org/cwm/gender-gap-in-science-database>

<sup>9</sup> <https://gender-gap-in-science.org/promotional-materials/>

there is no significant difference between answers from all sciences and those from mathematics. This in itself is important information, which should encourage self-examination and relevant initiatives within the mathematical community. In a few cases the situation is more positive for mathematics than in all sciences. In a context of widespread sexual harassment in the scientific community [3], women in mathematics are however less likely to have been sexually harassed. On the other hand, the situation seems to be worse for women in mathematics as it is for all sciences in a whole variety of situations: in particular, during their studies, women received less support from other students; women receive less government income during their working lives; they also have fewer opportunities to serve on editorial boards.

The mathematical community has a responsibility to make special efforts to understand the mechanisms of the gender gap in mathematics and to reduce it. Participation in interdisciplinary and international initiatives to reduce sexual harassment in the scientific community remains essential. Inside the mathematical community, encouraging a women-friendly atmosphere for women during studies and at work, organising equal access to resources, considering specific situations related to parenthood or family care, and promoting the visibility of women in mathematics would already be important steps in the right direction.

## Appendix: Methods of data analysis

### Data

We use aggregated data collected as part of the Gender Gap project. The data was accessed and extracted via a platform based at the American Institute of Physics, which protects and anonymizes individual data. The platform (Aircloak) ensures anonymity by applying some filters and distortion to the extracted information, which had the effect of limiting the access of the data.

Generally speaking, the databases at our disposal are anonymized, aggregated and available in the form of frequency tables.

It is important to mention that all the data we are working with are categorical, which means that they have a structure of possible answers. Most questions have two possible answers like “yes” or “no,” but we also have questions with three or more possible answers, for instance, the question “Have you encountered sexual harassment at school or work?”. Gender is identified as “female” or “male,” and the Human Development Index (HDI) has four categories: “very high,” “high,” “medium,” and “low.”

Taking into account the aggregated structure of our data, in the first analysis we looked at the gender distribution for each question, and then we applied comparison of proportion tests to assess whether the distribution of the question studied for the two populations of interest (men and women) is statistically equal in each sample and in the sub-samples. This gives an indication

of the distribution of individuals and makes it possible to distinguish the existence of groups sharing similar characteristics in our data.

In addition to these analyses, we perform multivariate analysis using logistic and multinomial aggregated regression models [7] since most questions have two possible answers (e.g., “yes,” “no”), and a small number of questions have three or more possible answers. The logistic (resp., multinomial) regression model uses a distribution function to model a binary dependent variable (resp., one with multiple nominal values) in relation to other exogenous variables. Using these models, in particular the odds ratio, we can estimate a potential effect of the gender gap that we want to measure given a certain number of confounding variables. It is important to note that these multivariate models are adapted to take into account the aggregated structure of our data.

In all the results we presented in the article to illustrate the gender gap, the multivariate analysis confirmed that the difference we observe between women and men is not due to confounding variables such as age, sector of employment, geographical region, or the country’s HDI (Human Development Index).

### Filtered data

Filtering was performed on the original individual data using a zero-mean *Gaussian noise* and *low count filtering* to avoid accessing individual answers and infrequent answers. The zero-mean noise filter adds a zero-mean Gaussian noise to the query output tables containing the number, sum, mean, standard deviation, and variance. The noise is proportional to the users most influential on the output and also means that the extracted tables will contain a variation from one to six observations from the raw tables. Noise is proportional to query complexity, meaning that the more complex the query, the more noise is introduced in the output table. For example, a simple query requesting frequency tables for two variables has a base noise layer equal to 2. It modifies values of outlying data, particularly those associated with minimum and maximum values.

*Low count filtering* eliminates values that do not appear frequently enough or outlying observations. It removes a line when the individual contributing to a single output is too small. More precisely, when the output line contains a number of observations less than or equal to four, the line is automatically hidden.

In some cases, the data may pass the low-count filtering, but there is not enough information to provide the aggregate value requested, such as the average, variance, etc. In this case, the output table will indicate a null value for the lines concerned.

The reported table may contain some lines in italics, which means that the aggregate for that particular line is calculated with a number of observations less or equal to 15. This is also a reminder that the results contain a high relative noise.



In addition, we observe that the more disaggregated the information we want to extract from a single table, the more that table will be penalised. In line with the recommendations of the Aircloak user guide, we construct a query by placing categorical variables with few possible answers first and adding categorical variables with a greater number of possible answers at the end. So instead of having individual data with particular characteristics, we have a group of individuals who share those particular characteristics.

## References

- [1] J. L. Beery, S. J. Greenwald and C. Kessel (eds.), *Fifty years of women in mathematics: reminiscences, history, and visions for the future of AWM*. Assoc. Women Math. Ser. 28, Springer, Cham (2022)
- [2] B. A. Case and A. M. Leggett (eds.), *Complexities: Women in mathematics*. Princeton University Press, Princeton, NJ (2005) <https://press.princeton.edu/books/paperback/9780691171098/complexities>
- [3] Fondation L'Oréal and IPSOS, *One in two women scientists say they have experienced sexual harassment at work*. (2023) <https://www.ipsos.com/en/one-two-women-scientists-say-they-have-experienced-sexual-harassment-work> (retrieved 16 September 2023)
- [4] R. G. Fryer, Jr. and S. D. Levitt, *An empirical analysis of the gender gap in mathematics*. *Am. Econ. J.: Appl. Econ.* 2, 210–240 (2010)
- [5] C. Guillopé and M.-F. Roy (ed.), *A global approach to the gender gap in mathematical, computing, and natural sciences: how to measure it, how to reduce it?*. International Mathematical Union, Berlin (2020)
- [6] R. Ivie and S. White, Measuring and analyzing the gender gap in science through the global survey of scientists. In [5], pp. 39–81.
- [7] G. James, D. Witten, T. Hastie and R. Tibshirani, *An introduction to statistical learning: with applications in R*. Springer, New York (2013)
- [8] R. Kelly and M. Goos, Some initiatives for reducing the gender gap in science: a database of good practices. In [5], pp. 157–176.
- [9] T. H. Kjeldsen, N. Oswald and R. Tobies, *Mini-workshop: Women in mathematics: historical and modern perspectives*. *Oberwolfach Rep.* 14, 83–131 (2017)
- [10] H. Mihaljević and L. Santamaría, Measuring and analyzing the gender gap in science through the joint data-backed study on publication patterns. In [5], pp. 85–153.
- [11] H. Mihaljević and L. Santamaría, *Mathematics publications and authors' gender: Learning from the Gender Gap in Science project*. *Eur. Math. Soc. Mag.* 123 (2022), 34–38
- [12] C. A. Rivera Martinez, *Gender gap in science: Mathematics, applied mathematics, and Africa*. Rapport de stage de Master 2 Statistique et Science de Données, CNAM, Paris (2021)
- [13] UNESCO Institute for Statistics, *Women in Science*. Fact Sheet No. 55, FS/2019/SCI/55 (2019) <https://uis.unesco.org/sites/default/files/documents/fs55-women-in-science-2019-en.pdf> (retrieved 17 July 2023)
- [14] World Economic Forum, *Global Gender Gap Report 2022*. Coligny/Geneva (2022) <https://www.weforum.org/reports/global-gender-gap-report-2022/> (retrieved 13 June 2023)

---

Sophie Dabo-Niang is a professor at the University of Lille (France). She works on the representation of time and space in random environments through the use of stochastic methods driven by real problems in various areas. She chaired the EMS CDC Committee of Developing Countries, and has been a scientific officer of CIMPA (International Center of Pure and Applied Mathematics). She is currently a member of the Committee of Diversity of the International Mathematical Union.

[sophie.dabo@univ-lille.fr](mailto:sophie.dabo@univ-lille.fr)

Maria J. Esteban is an emerita senior researcher at CNRS in Paris. She is a specialist in linear and nonlinear partial differential equations, nonlinear analysis and mathematical physics. She has been president of the SMAI (the French Society for Applied and Industrial Mathematics) and of ICIAM (The International Council for Industrial and Applied Mathematics), and has been chair of the EMS Applied Mathematics Committee. Currently, she is a member of the Scientific Advisory Board of EMS Press.

[esteban@ceremade.dauphine.fr](mailto:esteban@ceremade.dauphine.fr)

Colette Guillopé is an emerita professor at the Université Paris-Est Créteil. She is a specialist in nonlinear partial differential equations, particularly in fluid mechanics. She has been president of the French associations Femmes et Mathematics (Women and Mathematics) and Femmes & Sciences (Women & Science), and is Vice President of the European Platform of Women Scientists. She has been one of the coordinators of the publication of the final book of the Gender Gap in Science project.

[colette.guillope@u-pec.fr](mailto:colette.guillope@u-pec.fr)

Marie-Françoise Roy is an emerita professor at University of Rennes (France). She is a specialist in algorithms in real algebraic geometry. She has been president of SMF (the French Mathematical Society), the convenor of European Women in Mathematics and the chair of the Committee for Women in Mathematics of the International Mathematical Union. One of the leaders of the Gender Gap in Science project, she is the communication officer of the Standing Committee for Gender Equality in Science.

[marie-francoise.roy@univ-rennes1.fr](mailto:marie-francoise.roy@univ-rennes1.fr)

# Expanding our horizons: Research with developing countries

Christophe Ritzenthaler

Mathematicians feel part of a worldwide community: we share the same language; the concepts and tools are available anywhere and anybody willing to contribute to research is welcome. This idealistic statement must be confronted with the fact that research in the world is not homogeneously distributed: for instance, Africa, with 1/6 of the human population, has only 2.4% of the researchers and produces only 3.5% of the yearly scientific publications (90% of those in 12 countries, 25% in South Africa alone). CIMPA's purpose is to help rebalance this situation.

## What is CIMPA?

The *International Centre for Pure and Applied Mathematics* (Centre International de Mathématiques Pures et Appliquées – CIMPA<sup>1</sup>) is a French association founded in 1978. Its mission is to promote international research in mathematics with developing countries. Based in Nice, on the campus of Université Côte d'Azur, CIMPA is



Campus Valrose of the Université Côte d'Azur, Nice.

a UNESCO category 2 centre and receives financial support from 5 member states: France, Germany, Spain, Norway, and Switzerland.

## What does CIMPA really mean?

Most people believe that the CIMPA acronym was created with reference to the word “sympa” in French which means nice/friendly. Actually, the idea of CIMPA was launched during a UNESCO conference in Nairobi in 1976, and it comes from Swahili “simba,” the lion, apparently a reference to a famous French mathematician.

## What is special about CIMPA?

As one of the main actors of the international cooperation in mathematics research with developing countries, CIMPA has several unique features and assets:

- It is a strongly connected association that coordinates joint projects with major national and international stakeholders in mathematics.



Meeting in June 2023 at the Centre International de Rencontres Mathématiques with International Science Programme, EMS Committee for Developing Countries, IMU Committee for Developing Countries, London Mathematical Society and International Centre for Theoretical Physics (ICTP).

<sup>1</sup> <https://www.cimpa.info>

- It is run by and with mathematicians: collaborators and instructors are colleagues and work as volunteers. We understand their needs when preparing the calls and the events.
- More than 40 years of experience has created trust and visibility. CIMPA's management is known to be responsive and reliable, and our calls are sent through a monthly newsletter (subscribe!<sup>2</sup>) with more than 10,000 subscribers.
- An international independent Scientific Council<sup>3</sup> of mathematicians evaluates the scientific contents of applications and a Steering Committee<sup>4</sup> decides on the relevance of the events based on these evaluations.
- We have proximity to the field thanks to our Scientific Officers,<sup>5</sup> who help the organisers of research schools during the application process and then during the school. Their presence at the events also allows them to develop new contacts and share opportunities with the participants.

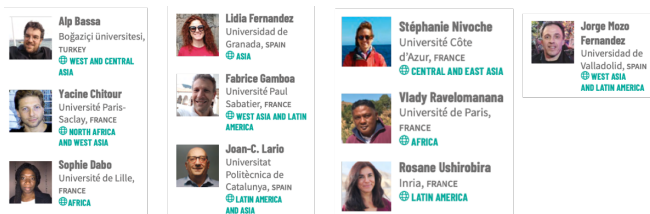

CIMPA Scientific Officers.

## What does CIMPA do?

Each year, CIMPA co-organises and finances several activities with developing countries on all continents. Each of these activities is subject to yearly calls for projects and applications in one of the following categories (more information can be found on our website<sup>6</sup>):

- **CIMPA Research Schools:** these are organised by two coordinators, one from a member state, the other based in the developing country where the school will be held over two weeks for the benefit of participants from the region. Between 1997 and 2023, CIMPA organised more than 420 CIMPA schools<sup>7</sup> in 73 countries. We insist on at least 30% female participation in the teaching team. These events give an international visibility to the host institute.

<sup>2</sup> <https://www.cimpa.info/en/node/6012>

<sup>3</sup> [https://www.cimpa.info/en/scientific\\_council](https://www.cimpa.info/en/scientific_council)

<sup>4</sup> [https://www.cimpa.info/en/steering\\_committee](https://www.cimpa.info/en/steering_committee)

<sup>5</sup> <https://www.cimpa.info/en/node/6191>

<sup>6</sup> <https://www.cimpa.info/en>

<sup>7</sup> <https://www.cimpa.info/en/node/36>



A CIMPA research school.

- **Schools in Partnership:** CIMPA supports and helps to organise undergraduate- and graduate-level mathematics schools in partnership with continental and regional mathematical societies. These schools are mostly aimed at students from the country in which they take place. The calls for projects and selections are managed by committees with representatives of the African Mathematical Union, Unión Matemática de América Latina y el Caribe, the Southeast Asian Mathematical Society and the Asian and European Schools of Mathematics.



A CIMPA school in partnership with the African Mathematical Union.

- **CIMPA Courses:** This programme consists of supporting the organisation of master's- and research-level courses in developing countries. This scheme enables a fast and flexible response to a precise need in the academic syllabus, serves as prepara-



A CIMPA course.

tion for or follow-up of another event, or provides long-term support to an emerging master's programme. Since the introduction of this activity in early 2017, CIMPA has funded more than 110 CIMPA Courses.

- **CIMPA Fellowships:** Since 2017, the CIMPA fellowship programme has funded the participation of young mathematicians from developing countries in international thematic programmes (of at least a month) organised by partner research centres in France and in Spain. 73 mathematicians (34% of them women) have participated, with an average of 3 laureates per thematic programme. New programmes with Switzerland and Norway will start in 2024.
- **CIMPA–ICTP Research in Pairs:** In 2021, CIMPA started a new programme, Research in Pairs,<sup>8</sup> which makes it possible for established colleagues based in a developing country to come to Europe to work with another researcher on a well-substantiated research project for a minimum period of 6 weeks. During her/his stay, the laureate will also broadcast/record a mini-course.<sup>9</sup> In 2022, ICTP joined the programme. In 3 competitive calls, 30 laureates (37% of them women) have been selected from more than 230 applicants.



Two laureates at the Institut Henri Poincaré.



Research group during a CIMPA school at the Nesin Village.

memberships of Spain (2009), Norway (2011), Switzerland (2011) and Germany (2021). Possible extensions with other countries are under discussion.

CIMPA also has close relations with several research centres:

- Through the CIMPA fellowships programme: Institut Henri Poincaré (Paris, France), the Centre de Recerca Matemàtica (Barcelona, Spain), the Centre International de Rencontres Mathématiques (Marseille, France), SwissMAP (Les Diablerets, Switzerland), and the Lie–Størmer Center (Tromsø, Norway).
- Through the CIMPA–ICTP Research in Pairs, since some research centres have agreed to welcome the laureates and their host for a week in their premises: the Centre de Recerca Matemàtica (Barcelona, Spain), the Centre International de Rencontres Mathématiques (Marseille, France), Forschungsinstitut für Mathematik (Zürich, Switzerland), and Mathematisches Forschungsinstitut Oberwolfach (Oberwolfach, Germany).

**▶ ONLINE**

## CIMPA-ICTP COURSES

*"Analytical Properties and Applications of Orthogonal Polynomials and Special Functions"*

**On Zoom**

(Paris time zone)

📅 MONDAY, 3 APRIL: 2:00 PM - 4:00 PM  
📅 TUESDAY, 4 APRIL: 2:00 PM - 4:00 PM  
🕒 WEDNESDAY, 5 APRIL: 2:00 PM - 4:00 PM  
🕒 THURSDAY, 6 APRIL: 2:00 PM - 4:00 PM



**SPEAKER**  
Salameh Sedaghat  
Buenos Aires Technical University (Iran)

## CIMPA in Europe

Although CIMPA is a French association, in the last 15 years it has been progressively developing a European dimension, with the

## What is the future of CIMPA?

The world is changing at a fast pace, and it is hard to predict how it will evolve, with many threats to its future. What we observe:

- Security issues, prices of airline tickets and carbon footprint impact make it less easy to organise our meetings. However, our partners always take great care to receive us with the greatest hospitality and attention. Although it is important to reduce our carbon impact globally, it would be sad to cut collaborations with the countries which pollute the least and have not yet benefitted from international collaborations.
- The pandemic has revealed and improved the possibilities for online collaborations. It has also shown the current limitations, and so one must find a synergy between online and in-person activities. At CIMPA, we believe in encouraging collaborative activities as they maximise the benefit of human interactions and are difficult to do online.



<sup>8</sup> <https://www.cimpa.info/en/node/7159>

<sup>9</sup> Some examples are available at <https://www.youtube.com/@cimpamath7472/playlists>.



Group picture during a school in partnership in Rwanda.

- It will be important to reinforce South-South collaborations by creating structures located in developing countries along with new tools to help our colleagues find time to develop their research. CIMPA is not large enough to do this alone, but will strengthen its coordination with other agencies to work in this direction.

#### How can you contribute?

- Participate in a CIMPA school: although participants from developing countries are the main audience and are the only ones who can be supported financially by CIMPA, it is good for young participants from these countries to meet other young participants from Europe and build connections.<sup>10</sup>
- Stay in touch through our networks (newsletter,<sup>11</sup> CIMPA on Facebook<sup>12</sup> or CIMPA friends).
- Advertise our activities among your professors or colleagues.
- Become an instructor or an organiser of an activity. Our calls for events are not like ERC calls: all applications that have been prepared with care are usually selected and CIMPA's Scientific Officers are here to help you through the application process.

---

Christophe Ritzenthaler is professor of mathematics at Université Rennes 1 and Université Côte d'Azur and has been executive director of CIMPA since 2020.

[director@cimpa.info](mailto:director@cimpa.info)

---

<sup>10</sup>You can find the list of schools for 2024 at [https://www.cimpa.info/en/schools\\_list\\_with\\_map/2024](https://www.cimpa.info/en/schools_list_with_map/2024).

<sup>11</sup><https://www.cimpa.info/en/node/6012>

<sup>12</sup><https://www.facebook.com/people/CIMPA-Centre-International-de-Mathématiques-Pures-et-Appiquées/100069451794798>

## New EMS Press book

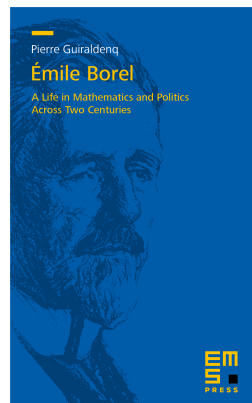

**Émile Borel**  
A Life in Mathematics and Politics  
Across Two Centuries

Pierre Guiraldenq  
(École Centrale de Lyon)

Translated and edited by  
Arturo Sangalli

ISBN 978-3-98547-013-6  
eISBN 978-3-98547-513-1

2022. Softcover. 122 pages.  
€ 19.00\*

Émile Borel, one of the early developers of measure theory and probability, was among the first to show the importance of the calculus of probability as a tool for the experimental sciences. A prolific and gifted researcher, his scientific works, so vast in number and scope, earned him international recognition. In addition, at the origin of the foundation of the Institut Henri Poincaré in Paris and longtime its director, he also served as member of the French Parliament, minister of the Navy, president of the League of Nations Union, and president of the French Academy of Sciences.

The book follows Borel, one of France's leading scientific and political figures of the first half of the twentieth century, through the various stages and the most significant events of his life, across two centuries and two wars.

Originally published in French, this new English edition of the book will appeal primarily to mathematicians and those with an interest in the history of science, but it should not disappoint anyone wishing to explore, through the life of an exceptional scientist and man, a chapter of history from the Franco-Prussian War of 1870 to the beginnings of contemporary Europe.

*\*20% discount on any book purchases for individual members of the EMS, member societies or societies with a reciprocity agreement when ordering directly from EMS Press.*

EMS Press is an imprint of the European Mathematical Society – EMS – Publishing House GmbH  
Straße des 17. Juni 136 | 10623 Berlin | Germany  
<https://ems.press> | [orders@ems.press](mailto:orders@ems.press)



ADVERTISEMENT

# EURO conferences

Graham Rand

*The origins and subsequent history of the European Conferences of Operational Research are presented.*

Later this year, from 30 June to 3 July, the 33rd European Conference of Operational Research will be hosted in Copenhagen, Denmark at the Technical University of Denmark (DTU) on behalf of EURO.<sup>1</sup> That straightforward statement begs, for many readers, at least two questions: What is operational research? And what is EURO? Maybe there is a third: Why is this being included in the Magazine of the European Mathematical Society? I hope the answer to the first question will also answer the third.



Nyhavn, Copenhagen.

## Operational research

The term *operational research* (OR) was first coined in the late 1930s in the UK, as preparation was made for war. Many scientists had been called from their university laboratories to aid the war

effort. Amongst these was Patrick Blackett, professor of physics at the University of Manchester, known for his work on cloud chambers and cosmic rays, who was to be awarded the Nobel Prize in Physics in 1948. During the Second World War he made a major contribution advising on military strategy using a scientific approach to the solution of problems that were faced. He was director of Operational Research within the Admiralty from 1942 to 1945 and is known, certainly in the UK, as the father of operational research.

The scientists used no formal OR methodology during the war, as none existed. Their approach involved collecting real data about operations and analysing it using statistical and mathematical methods, simply applying their scientific approach. After the war new analytical areas evolved within OR, most notably linear programming, which developed into various forms of mathematical programming. Other approaches now in the OR analysts' tool bag include simulation, game theory, queueing theory, network analysis, decision analysis, and multicriteria analysis. All these have powerful application to practical problems with the appropriate logical structure. However, it is not only mathematical, analytical, methods that are in the tool bag. Most of the problems tackled by OR are messy and complex, so a systems approach is frequently required, and methods of problem structuring, such as soft systems methodology, are often used.

Operational researchers are concerned to enable decision-makers to make better decisions. OR is used by organisations of all sizes, including businesses across all industry sectors, government and other public sector bodies, charities, communities and even individuals. OR helps inform strategic, tactical, and operational decisions as well as assisting in the design of public policy.

An idea of the range of problems that are tackled by OR can be found by considering the six finalist presentations of the 2021 EURO Excellence in Practice Award at EURO 31 in Athens, a hybrid conference, the last time the award was made. Two, both from the UK, concerned health. The winning project investigated emerging health threats, such as the coronavirus global pandemic, which create extensive health, economic and social problems. A key challenge for health experts and policy-makers is deciding how to

<sup>1</sup> <https://euro2024cph.dk>

balance and reduce the risk of these threats. The use of OR models and processes by health experts and policy-makers enhanced the quality of health experts' recommendations to the leadership of the UK Department for Environment, Food and Rural Affairs in the prioritisation of animal and human emerging health threats and informed new international standards for the Food Standards joint programmes of the Food and Agriculture Organization of the United Nations and the World Health Organization. The second concerned shaping demand for urgent care, via an app to inform patients of alternative facilities for care.

Three finalist entries concerned a variety of transport applications: airport staff scheduling at Swissport International, truck drayage dispatching and appointment booking in the Port of Hamburg, and the transformation of Italmundo's cargo loading operations. The sixth finalist sought to increase safety during the Hajj.

## EURO

After the Second World War, many of the scientists in the UK, including Blackett, returned to their university laboratories. Others, however, stayed in the defence sector, or went into private or nationalised industries to practice OR. An OR Club was formed in 1948, which later became the Operational Research Society (ORS). OR societies were also formed in other countries. In 1957, an international conference was held in Oxford, England, following which the International Federation of OR Societies (IFORS) came into existence in 1959. The immediate main activity of IFORS was the organisation of triennial international conferences for the world community of operational researchers. Following Oxford, the next two were held in Europe: in 1960 in Aix-en-Provence, France, and in 1963 in Oslo, Norway.

Understandably, the IFORS conferences moved out of Europe – firstly to the USA in 1966. At the 6th IFORS conference (Dublin, 1972), the participating presidents of European OR societies realised that there would not be a conference in Europe for a further nine years and, having discussed the situation, agreed to consider setting up a European coordinating body [8]. At a meeting of representatives of European OR societies, held in Amsterdam on 3–4 May 1974, two major decisions were made: to formalise and institutionalise increased European cooperation, drafting an agreement between the European OR societies, and that there should soon be a European Conference on Operational Research.

This conference was held in January 1975 in Brussels, Belgium, hosted by the Belgian OR Society, with the OR societies of Denmark, Germany, United Kingdom, Norway, the Netherlands, and Sweden helping with finance. The objective of formalising closer cooperation amongst the European operational researchers was achieved at the conference: ten European OR societies (of Belgium, Denmark, Finland, Germany, Great Britain, Greece, Ireland, the Netherlands, Sweden, Switzerland) gave birth to EURO, The Association of



Signing EURO into existence at EURO I, Brussels 1975.

European Operational Research Societies within IFORS, by signing an agreement.

On 8 March 1976, in a circular letter to all European OR societies, the honorary secretary announced: "I hereby declare that EURO, The Association of European Operational Research Societies within IFORS, is now formally constituted with effect from 5 March 1976" [5]. By 18 June 1976 "the definitive statutes and by-laws of EURO were ratified in total by the OR societies of: Belgium, Denmark, France, Germany, Greece, Ireland, Italy, The Netherlands, Spain, Switzerland and the United Kingdom" [4].



The membership of EURO has increased as more European national societies joined IFORS and countries outside Europe which joined IFORS, but where there was no regional grouping, also became part of EURO. There are now 31 member societies within EURO, including Israel, South Africa, and Tunisia.<sup>2</sup>

The idea of starting a European journal was raised in the first meeting in Amsterdam in 1974. The first issue of the *European Journal of Operational Research* (EJOR) appeared in 1977, a month after the second EURO conference. Since then, it has continuously grown in terms of reputation and quality (through measures such as the impact factor) to be one of leading journals of the international OR community.

## EURO conferences

As mentioned previously, the first European Conference on Operational Research (EURO I) was held in Brussels in January 1975, only nine months after the 1974 Amsterdam meeting. That there were 506 participants is a tribute to the commitment of all those who participated in the preparatory work.

<sup>2</sup> <https://www.euro-online.org/web/pages/1457/current-member-societies>

Following the success of EURO I, a second conference was held in Stockholm in 1976. In 1977, EURO co-sponsored an Institute of Management Science (TIMS) international meeting, held in Athens, Greece. Other conferences have been held jointly with TIMS: in 1982 (Lausanne), 1988 (Paris), 1992 (Helsinki) and with INFORMS (created by the merger of TIMS and the Operations Research Society of America) in 1997 (Barcelona), 2003 (Istanbul), and 2013 (Rome). The last-mentioned conference attracted over 3500 participants, but before the coronavirus pandemic, there were typically 2500 participants.

Observant mathematicians will have noticed the contradiction between EURO I in 1975, the first annual conference, and the fact that the conference in 2024, some 49 years later, is the 33rd. IFORS hold a conference every three years. EURO, as a regional grouping of IFORS' member societies, does not hold a conference in that year, hence the discrepancy. I have been privileged to attend 24 EURO conferences: Copenhagen will be my 25th.

22 member societies have hosted the conference. The UK Operational Research Society has hosted the conference three times, twice in Glasgow, and is due to host it a fourth time in 2025, in Leeds, when the 50th anniversary of EURO will be celebrated. In addition to Glasgow, the conference has been held twice in Brussels, Lisbon, and Helsinki. Other societies to host the conference twice are those of Greece (in Rhodes and Athens), Spain (in Barcelona and Valencia), Italy (in Bologna and Rome), Germany (in Aachen and Bonn), and the Netherlands (in Amsterdam and Rotterdam). Surprisingly, of the twelve societies ratifying the statutes and by-laws of EURO in 1976, one has never hosted a conference: Denmark. That anomaly is being corrected this year. It may be confusing that the conference logo refers to the year and not the sequence number of the conference.



### EURO Gold Medallists

One of the features of the conferences is the award of the EURO Gold Medal, the highest recognition in Europe for scientific activity in OR, which is followed by a lecture from the laureate. Typically, the Gold Medallists are acknowledged for their contribution within the OR profession, but there have been some notable exceptions. In 1989 in Belgrade, for instance, the Gold Medallist was Claude Berge, a French mathematician, recognised for his contributions to combinatorics and graph theory. The chair of the jury introduced his lecture [3] by stating: "It is difficult to overestimate the influence which his work has had on the corpus of theory which is used by Operational Research workers. His books are among the most often quoted in OR, as OR workers apply graphical techniques to network flows, to methods for scheduling and timetabling and to



EURO 27 Glasgow 2015.

combinatorial optimisation. His skill has been to demonstrate how graph theory and hypergraph theory can solve widely disparate and well-known problems such as the schoolgirl problem, the problem of joining three houses by pipelines to three utility companies and the map colouring problem, to mention but a few" [7].

In 2001 the award was made to Egon Balas [6].<sup>3</sup> He was a pioneer in the study of the structure of integer polytopes, and in the development of enumerative and cutting plane algorithms for the solution of NP-hard zero-one programming problems. With his co-workers, he developed the "lift-and-project" approach, which plays a key role in the improvement of the performance of the Branch-and-Cut algorithms, and which is included in the most effective packages designed for the solution of integer programming problems. But perhaps even more impressive than his scientific contributions is the story of a remarkable life, told in his autobiography [1]. Egon Balas was born in what is now Romania to a Hungarian family. In 1942, he joined the underground Hungarian Communist Party. Two years later he was arrested by the Hungarian fascist authorities, escaping after a few months. In 1952, he was again arrested, this time by the Romanian communist government, and put in solitary confinement for two years. In 1966, after his release, he left Romania with his family and immigrated to the United States in 1967, where he continued his stellar academic career.

<sup>3</sup> His lecture [2] can be seen at <https://www.euro-online.org/web/pages/1665/2001-rotterdam-euro-k>.



## Other memories

Of course, as past EURO conferences are recalled, it is not necessarily the enjoyment of meeting colleagues and learning from presentations and discussions that spring first to mind. For many, the memories are of other activities that form part of the conference experience. On arrival at the dinner at the 2001 conference in Rotterdam, for instance, we found a conference T-shirt in distinctive Dutch orange placed on the back of our chairs. Before we left, we were persuaded to wear them and sing the specially composed song “OR Forever” to the tune of “We are the Champions”.

Another memorable occasion was the welcome reception at the 2006 conference in Iceland held at the Blue Lagoon. Swimming together in the warm water gave a different perspective on the other conferees. The welcome event for the EURO 2018 meeting in Valencia featured very loud firecrackers in a display typical of the Valencian community, though these fireworks did not have much visual appeal. However, this was certainly not the case with the firework display following the conference dinner: a stunning display lit up the night sky over the impressive architecture of Valencia’s City of Arts and Sciences.

Great memories. I wonder what EURO 33 will have in store.

## References

- [1] E. Balas, *Will to freedom: A perilous journey through fascism and communism*. Syracuse University Press, Syracuse, NY (2000)
- [2] E. Balas, [Some thoughts on the development of integer programming during my research career – lecture delivered upon receiving the EURO Gold Medal, July 9, 2001, Rotterdam](#). Eur. J. Oper. Res. **141**, 1–7 (2002)
- [3] C. Berge, [Optimisation and hypergraph theory](#). Eur. J. Oper. Res. **46**, 297–303 (1990)
- [4] J. P. Brans, [EURO bulletin 6](#). Eur. J. Oper. Res. **1**, 69–71 (1977)
- [5] G. K. Rand, [Forty years of IFORS](#). Int. Trans. Oper. Res. **8**, 611–633 (2001)
- [6] G. K. Rand, [IFORS’ operational research hall of fame: Egon Balas](#). Int. Trans. Oper. Res. **13**, 169–174 (2006)
- [7] M. F. Shutler, [The fifth EURO Gold Medal 1989](#). Eur. J. Oper. Res. **46**, 295–296 (1990)
- [8] H.-J. Zimmermann, [The founding of EURO, the Association of European Operational Research Societies within IFORS](#). Eur. J. Oper. Res. **87**, 404–407 (1995)

---

Graham Rand retired as a senior lecturer in operational research at Lancaster University, UK in 2016. He has been council member and twice conference chairman for the British Operational Research Society and was editor of the Journal of the Operational Research Society for six years from 1991 to 1996. He was founding editor of the Society’s magazine, *Impact* (2014–2022). For the International Federation of Operational Research Societies (IFORS) he was vice-president (1998–2000) and has been editor of both *International Abstracts in Operations Research* (1980–1991) and *International Transactions in Operational Research* (2000–2005). He was editor of the proceedings of the IFORS Conference held in Buenos Aires in 1987, and chairman of the Program Committee for the IFORS Conference held in Athens in 1990. For the European Association of Operational Research Societies he was chairman of the Gold Medal jury in 1995 and member of the Organising Committee for the 15th conference in Barcelona in 1997. He was president of Omega Rho, the international honour society for operational research in 2012–2014.

[g.rand@lancaster.ac.uk](mailto:g.rand@lancaster.ac.uk)

# Are old mathematicians useless?

Albrecht Pietsch

In the interest of better readability, this article is divided into four sections: (1) *Hardy's standpoint* on the matter, (2) examples of *useful old mathematicians*, (3) the *author's standpoint*, and (4) *final remarks*.

## 1 Hardy's standpoint

We begin with some comments about *Godfrey Harold Hardy*, who lived from 7 February 1877 until 1 December 1947. Hardy urgently requests that old mathematicians should stop mathematical research, but he never says what they could do for the rest of their lives.

The subsequent quotations can be found in [5, pp. 72 and 148].

*I do not know an instance of a major mathematical advance initiated by a man past fifty.*

*A mathematician may still be competent enough at sixty, but it is useless to expect him to have original ideas.*

In the preceding statements Hardy uses two bounds, “fifty” and “sixty”. In my opinion, this difference is inessential, since any age limit should be avoided.

Hardy wrote his “Apology” at the age of 63. We know from C. P. Snow’s foreword that, fully aware of his decreasing mental power, Hardy was already extremely depressed. In the summer of 1947 he even tried to commit suicide; see [5, p. 54]. When following Hardy’s life strategy, his true fans should take these facts into account.

Mathematicians certainly attain the maximum of their efforts at an age much less than fifty, which is also reflected by the Fields Medal. In Hardy’s words: “*Mathematics is a young man’s game*”; see [5, p. 70]. But some are able to keep their high level very long. More cannot be expected.

Hardy made several clever comments concerning the definition of “good” mathematics, which should be read in the original; see [5, p. 89]. However, in real life one falls the *circulus vitiosus* shown in Figure 1.

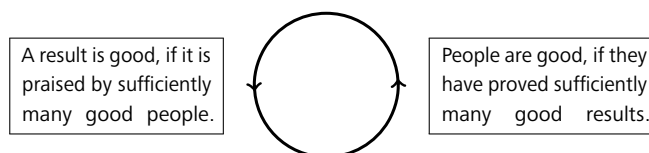

Figure 1. Circulus vitiosus.

## 2 Useful old mathematicians

The selection of successful old mathematicians is rather problematic. If we assume that there are at least five candidates in each of the 63 areas in the MSC2020 Mathematics Subject Classification System, then our task is to choose, by some kind of lottery, a few candidates out of more than 300. For sure, there is no shortage of examples. On the contrary, we have too many. Hopefully, the following (very subjective) choice is acceptable.

To keep this article short and effective, I only *name* specific persons, who proved remarkable results “past fifty”; details are not discussed.

Of course, we have the absolute giants: L. Euler (1707–1783), J. Liouville (1809–1882), K. Weierstrass (1815–1897), and A. Einstein (1879–1955).

What follows is a random list of further candidates to which everybody could add his own favourites: P. Erdős (1913–1996), I. Gelfand (1913–2009), E. Hlawka (1916–2009), B. Mandelbrot (1924–2010), J. P. Kahane (1926–2017), I. Gohberg (1928–2009), Sir M. F. Atiyah (1929–2019), D. Edmunds (1931), A. Schinzel (1937–2021), R. Schneider (1940).

Women are represented by O. Taussky-Todd (1906–1995) and D. Maharam (1917–2014).

To evaluate the late work of these personalities would be arrogant; what remains is my greatest respect.

Already older than sixty, Erdős (800), Gohberg (286), Gelfand (195), Edmunds (172), Kahane (142), Schinzel (137), Atiyah (121), Triebel (98), Mandelbrot (87), Schneider (85), Hlawka (84), Taussky (71), Johnson (39), Maharam (23), etc. wrote many publications. The parentheses above enclose quite exact numbers, found by using MR. Certainly, it is not only a spec-

ulation to expect that these contributions contain a lot of *top results*.

The subsequent table presents the reasonable number of ten examples in which a “performance peak” is attained after fifty; collected by using MR, zbMATH, www, and the references.

mathematician	age	subject
H. Poincaré (1854–1912)	58	three-body problem [11]
H. Cartan (1904–2008)	72	théories cohomologiques [3]
L. Schwartz (1915–2002)	58	book on cylindrical measures [13]
E. Calabi (1923–2023)	69	closed geodesics [2]
N. Kalton (1946–2010)	62	symmetric norms, etc. [6, 7]
H. Triebel (1936)	78	Navier–Stokes equations [14]
W. B. Johnson (1944)	69	approximation property [4]
R. Haydon (1947)	64	scalar-plus-compact problem [1]
T. Royen (1947)	67	Gaussian correlation conjecture [12]
Y. Zhang (1955)	59	bounded gaps between primes [16]

L. Vietoris (1891–2002) delivered his last paper [15] at the age of 103; MR confirms the substantial number of twelve citations.

### 3 The author’s standpoint

My own lifework provides some supplementary information on the issues discussed so far.

What follows is a short autobiography. Hopefully, the reader will get a positive picture of the author. This would justify all the efforts spent to write this article.

Indeed, Hardy’s “A Mathematician’s Apology” has become the main source of my mathematical philosophy. I learnt a lot from him. There is only one critical point: My strong rejection of the proposed *mathematical suicide*.

Without any intention to compare myself with Hardy, I vehemently state that loving mathematics knows no age limits.

Hardy stressed that intellectual curiosity, ambition, professional pride, and the desire for reputation are the driving forces behind the best works of the world; see [5, pp. 78–80]. He did not mention pleasure, and even love. Mathematical research should be considered not only as a competition, but also as a hobby. Of course, I am very pleased if somebody likes my results. However, I also appreciate the achievements of others. We are all in the same boat.

Here is a list of mathematical objects that have been of interest for me; half of them were introduced by myself and are often in use (by specialists).

- 1960  $\Phi$ -operators
- 1962 perfect spaces of vector-valued sequences
- 1962 nuclear locally convex spaces
- 1963 related operators

- 1963 approximation numbers
- 1967 absolutely  $p$ -summing operators
- 1968 operator ideals
- 1972  $s$ -numbers
- 1972 limit orders and their diagrams
- 1980 Weyl numbers
- 1980 eigenvalue distributions
- 1981 approximation spaces
- 1981 classical traces
- 1991 singular traces
- 1994 ideal norms associated with orthonormal systems
- 2012 shift-monotone sequence ideals
- 2012 Pietsch correspondence
- 2023 Lorentz sequence ideals

All research I did is concentrated on these concepts and their interplay. My interest in history started at the age of fifty.

From 1992 to 2000 I was twice elected as an Expert for Mathematics of the German Research Foundation. During the second period, I even became the chairman of the Mathematics Committee and wrote about 400 final reports.

I have published seven books; one is co-authored with my pupil Jörg Wenzel. “Nukleare lokalkonvexe Räume” has been translated from German into Russian and English, “Operator Ideals” from English into Russian. Important are also “Theorie der Operatoren-ideale” (1972), in German, a research program, and the “History of Banach Spaces and Linear Operators” (2007).

Figure 2 illustrates the time distribution of my 122 papers. Note that the irregularity in the period from 1996 to 2007 is caused by my work for the German Research Foundation and by writing the “History” book.

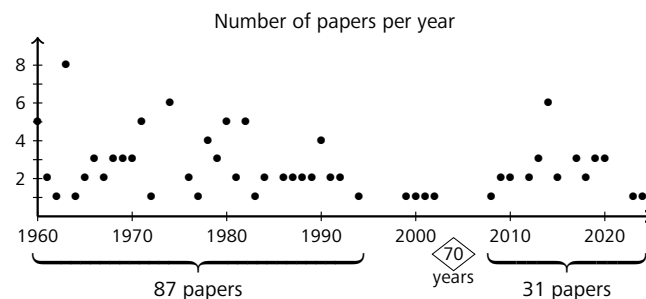

Figure 2. Distribution of the author’s publications.

Following Hardy’s mantra, I should have finished in 2007 with my comprehensive historical book. However, I started a “second” mathematical life, in which the basic approach to the theory of traces was fully rebuilt and essentially simplified; see [8, Chapter 4] and my paper [9, submitted at the age of 82]. The paper on Lorentz

sequence spaces also provides new insights; see [10, submitted at the age of 89].

Please, consider myself just as a supplementary example.

#### 4 Final remarks

Old colleagues may have lost their mental power or enthusiasm to continue mathematical research. So each person should alone decide what is possible and desirable. We need to respect the specific personalities. Tolerance is the main point.

Of course, proving theorems gives great satisfaction to old mathematicians. However, in my opinion, seniors also have the duty to pass on their know-how to the younger generations. They should communicate ideas about future developments; presenting collections of open problems is a good example.

Knowing the standpoints of many people is extremely important; but what really counts is the personal reaction of each individual reader. My final wish: Pay attention to your old colleagues and appreciate their lifework.

#### References

- [1] S. A. Argyros and R. G. Haydon, [A hereditarily indecomposable  \$\mathcal{L}\_\infty\$ -space that solves the scalar-plus-compact problem](#). *Acta Math.* **206**, 1–54 (2011)
- [2] E. Calabi and J. G. Cao, Simple closed geodesics on convex surfaces. *J. Differential Geom.* **36**, 517–549 (1992)
- [3] H. Cartan, [Théories cohomologiques](#). *Invent. Math.* **35**, 261–271 (1976)
- [4] T. Figiel, W. B. Johnson and A. Pełczyński, [Some approximation properties of Banach spaces and Banach lattices](#). *Israel J. Math.* **183**, 199–231 (2011)
- [5] G. H. Hardy, [A mathematician's apology](#). (With a foreword by C. P. Snow.) Canto, Cambridge University Press, Cambridge (1992)
- [6] N. Kalton and F. Sukochev, [Rearrangement-invariant functionals with applications to traces on symmetrically normed ideals](#). *Canad. Math. Bull.* **51**, 67–80 (2008)
- [7] N. J. Kalton and F. A. Sukochev, [Symmetric norms and spaces of operators](#). *J. Reine Angew. Math.* **621**, 81–121 (2008)

- [8] S. Lord, F. Sukochev and D. Zanin, [Singular traces. Vol. 1: Theory](#). De Gruyter Stud. Math. 46/1, De Gruyter, Berlin (2021)
- [9] A. Pietsch, [A new approach to operator ideals on Hilbert space and their traces](#). *Integral Equations Operator Theory* **89**, 595–606 (2017)
- [10] A. Pietsch, [Lorentz spaces depending on more than two parameters](#). *Ann. Funct. Anal.* **15**, article no. 16 (2024)
- [11] H. Poincaré, [Sur un théorème en géométrie](#). *Rend. Circ. Mat. Palermo* **33**, 375–407 (1912)
- [12] T. Royen, A simple proof of the Gaussian correlation conjecture extended to some multivariate gamma distributions. *Far East J. Theor. Stat.* **48**, 139–145 (2014)
- [13] L. Schwartz, [Radon measures on arbitrary topological spaces and cylindrical measures](#). Tata Institute of Fundamental Research Studies in Mathematics, No. 6, Oxford University Press, London (1973)
- [14] H. Triebel, [Hybrid function spaces, heat and Navier–Stokes equations](#). EMS Tracts Math. 24, European Mathematical Society (EMS), Zürich (2014)
- [15] L. Vietoris, Über das Vorzeichen gewisser trigonometrischer Summen. III. *Österreich. Akad. Wiss. Math.-Natur. Kl. Sitzungsber. II* **203**, 57–61 (1994)
- [16] Y. Zhang, [Bounded gaps between primes](#). *Ann. of Math. (2)* **179**, 1121–1174 (2014)

---

Albrecht Pietsch was born in 1934 in Zittau (Saxony), and studied at the University of Leipzig from 1953 to 1958. He received the Dr. rer. nat. from Dresden University of Technology in 1959 and the Dr. rer. nat. habil. from Humboldt University Berlin in 1963. Starting in 1965, Pietsch was a professor of analysis at the University of Jena for 35 years, where he supervised 27 Ph.D. students. Besides his monographs *Nuclear locally convex spaces*, *Operator ideals, Eigenvalues and s-numbers*, *Orthonormal systems and Banach space geometry* (co-author: J. Wenzel) and *History of Banach spaces and linear operators*, he published more than 120 research papers. From 1971 to 1990, National-Prize-Holder Pietsch was a member of the Academy of Sciences of the German Democratic Republic, and since 1974 he is a member of the Leopoldina (now German National Academy of Sciences). Honorary doctorates were awarded to him by the universities of Paderborn (1998) and Pretoria (2008). Present status: *Ostdeutscher Rentner*.  
[a.pietsch@uni-jena.de](mailto:a.pietsch@uni-jena.de)

## Jacob Murre (1929–2023)

A gentle mathematician

Ulf Persson

I first met Jacob Murre at the fabled AMS summer school of algebraic geometry at Arcata, in the summer of 1974. It was not really a conference, but a school, part of its purpose being to instruct and inspire young upcoming mathematicians. Consequently, people were encouraged not to speak on their own work, but on that of others, in the spirit of Séminaire Bourbaki, as Mumford, one of its organizers, expressed it. But it also could be seen as the first major gathering of algebraic geometers after the voluntary retirement of Grothendieck, thus the attendance by the stars of algebraic geometry was almost complete. To refer to myself as a young upcoming mathematician would make me guilty of conceit, but I was at least a graduate student of mathematics about to enter my final year. It was the first gathering of mathematicians outside my department I encountered, and as such it would have a momentous impact on my professional life; I was not only exposed to the leading senior geometers, but maybe more importantly to the truly upcoming in my own generation. It is a well-known secret that most math lectures tend to be incomprehensible, and, as Miles Reid has noted, their purpose is often just to impress on the audience the smartness of the lecturers, and I certainly must have been exposed to a fair

amount of that right then and there. So in fact the lecture I had the most lasting memory of was that given by Murre. It concerned the fairly recently established result of the cubic three-fold not being rational. True to the overall program, he was not reporting on his work, but on that of others; and I was both charmed by the contents and delighted by his very clear presentation, which was so easy to follow.<sup>1</sup> Doing explicit geometry on the 3-fold surely revealed to me up to then unknown gems, and revived my interest in mathematics which had recently been flagging.

Murre was a tall fellow, somewhat of a giant, and given his modesty it was inevitable that he was a bit stooped. I do not recall whether his mop of hair was already white at that time, anyway he would never lose it, only its color. He spoke slowly, with, I recall, a very light lisp; but his most notable feature was his modesty. He was a genuinely kind human being, who at times carried his kindness to an almost absurd length, with the complications due

---

<sup>1</sup> This is not actually quite true: although the theorem is of course due to Clemens and Griffiths, the algebraic presentation/proof of Murre was his own and a very first of its kind.



Murre with wife Elly at the celebration of Murre's 25th anniversary as a professor at Leiden, 1986. In the first with Alberto Conte, a long term collaborator, in the second with Alex Verrijn Stuart, a computer scientist. (Courtesy of Prof. Chris Peters.)

to logical contradictions this inevitable entails.<sup>2</sup> But of course this was not a problem at all, but just a lovable quirk, the kind of which every old-fashioned professor used to possess and actually should possess. Over the years I met him regularly at conferences, and also at the Mathematical Institute of Leiden University during the period in the early eighties when I was often visiting it. No lecture of his stood out in my memory as much as the first one I heard, but the circumstances would then be different, and he could hardly be blamed for them.

Murre did not have an academic background, in fact his father had a potato farm in the southern Netherlands. Furthermore, his schooling was disrupted by the World War II. But he was a bright boy and his potentials were readily recognized and appreciated, as was the custom in the old times, especially his mathematical ones. Advised by his father to study engineering, he was soon lured away to pure mathematics and coming under the mentorship of Kloosterman. One thing led to another. Murre read Weil's book *Foundations of Algebraic Geometry* and found there an open problem which interested him. Kloosterman, who knew Weil well, established the necessary contact and as a spinoff of the Marshall Plan, funds were supplied for a stipend, and after having attended his first ICM, which took place in Amsterdam 1954, the newly married couple took off for Chicago by boat and train. Chicago at the time was a mathematical hotbed, in addition to Weil, there were Borel, Lang, Chern, Matsusaka, Chow and temporarily Swinnerton-Dyer and Paul Cohen.

Two giants of algebraic geometry formed his future professional life. Weil, then at Chicago, as already noted, was the first; and Grothendieck at Paris, more specifically at the IHES, was the second. Weil was the first to formulate a foundation for algebraic geometry whose existence thereof had by the early forties come to be seen as sadly lacking. Murre took it seriously and spent a lot of effort to master it, only to be told by Weil himself that his efforts had been misguided; that he really should learn the language of schemes with which the young geometer Grothendieck seemed to perform miracles. You are a young man, Weil told him, and should jump on the bandwagon.<sup>3</sup> It must have been very bitter for Weil to admit that and to see himself being outdone by a young man more than twenty years his junior and with whom he had strained relations to boot; but it testifies to the moral integrity of mathematicians to



André Weil photographed by Herman Landshoff.  
© Münchner Stadtmuseum, Sammlung Fotografie, Archiv Landshoff

transcend their concerns for personal status and recognition; and I doubt that what Weil did would have been possible in many, if any, disciplines outside of mathematics. Murre himself was not so happy, it meant having to learn and master a new language; but it was after all not something entirely new. Weil's concern with different fields of definitions foreshadowed some features of Grothendieck's approach, only that Grothendieck had carried those to their logical extremes. The really new thing Grothendieck had brought, apart from his functorial mastery, was to include nilpotents, thus ultimately the notion of schemes was born. When Murre in 1962 started to attend the seminars at IHES, he was urged by Grothendieck to embrace schemes, which he finally did, realizing that it was mathematically inevitable, e.g., as the systematic use of nilpotents made the pathological behavior of Picard functors disappear, something which impressed him a lot. He would use the new insights in computing the algebraic fundamental group of a curve by lifting from finite characteristic to zero. Something well beyond the old viewpoints. But Murre did not lose his geometrical common sense, as that talk at Arcata testified to, i.e., he did not lose his down-to-earth connection to classical geometric thinking and intuition, maybe staying true to his potato-farming upbringing? Without this firm anchoring of your feet to the ground, your head will get lost in clouds of abstractions, because true inspiration emanates from the fertility of the soil.<sup>4</sup>

The collaboration with Grothendieck lasted for a long time and developed into a genuine friendship. In fact, Murre met

<sup>4</sup> It is worth pointing out that the same applied to Grothendieck as well, contrary to public appearances. Murre found that in private conversations he always revealed a concrete basis for his geometrical thinking.

<sup>2</sup> Examples of which float around in the community. If an explicit example be required, I can only in my own case on top of my head refer to the time I had sent him a photo of him, which I had printed and enlarged. He thanked me profusely and admitted that it was such a pleasant surprise, as he had thought it was just an article of mine. So that is what he thinks of my mathematics I thought, obviously not hurt at all, on the contrary, just rather amused. His accidental candor was refreshing.

<sup>3</sup> It might be worth pointing out that this advice was not given during Murre's first visit to Weil in Chicago, but at the Institute of Advanced Study at Princeton (to where Weil had moved) during a second trip to the US in 1960.



Alexander Grothendieck lecturing at the Séminaire de Géométrie Algébrique du Bois Marie at the IHÉS, photographed by René Bouillot, courtesy of the IHÉS Archives. © CSF/THALES

Grothendieck for the first time already in 1955 in Kansas, during his first visit to the States, but did not speak to him. He met him properly at ICM 1958 in Edinburgh, but it was not until four years later, when he attended his seminars in Paris, that he started to talk to Grothendieck privately. Grothendieck was at the time incredibly busy with mathematics, but he had always time to talk to Murre,<sup>5</sup> who was often invited to stay for dinner and as a consequence had to hurry to catch the last metro from Bures to Paris. At the end Murre had to witness with sadness Grothendieck's descent into isolation, and regretted that his mathematical peers did not support him in his 'Survivre' movement. Furthermore, he must have looked with puzzlement on Grothendieck's later autobiography. Although critical, he never lost his loyalty to the man himself, the combination of which is essential to every true friendship. And besides who knows, some of Grothendieck's outlandish ideas may one day in the future be viewed differently. In connection with Grothendieck's death, Murre was one of those chosen to convey memories of him in the pages of the EMS Newsletter. But those were of course only the tip of an iceberg, and one hopes that a fuller selection will eventually be made and published.

Of the mathematical work of Murre I will actually say very little, apart from pointing out that his introduction into the mathematical world was on his works on connectedness and Picard varieties, in the latter of which the need for new methods was really crying out, as already remarked. It also gave him a point of entry to Weil and Grothendieck, and prepared for his main work, which concerned the theory of cycles, where he had over the years a long ongoing 'conversation' with Spencer Bloch, whom he incidentally met at the abovementioned summer school in Arcata. He was also influenced by Grothendieck's vision of motives, which he tried to bring down

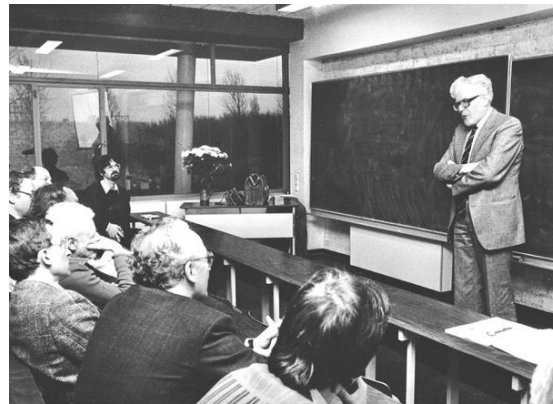

Murre lecturing in Leiden. (Courtesy of Prof. Chris Peters.)

to earth. For an excellent survey of Murre's mathematical work I can certainly not do better than to refer to the one given by Chris Peters in the NAW.<sup>6</sup>

For most of his professional life Murre worked at the Mathematical Institute at the Leiden University, where he along with his contemporary colleague, but yet so different, Antonius van de Ven ('Jaap' and 'Ton' in more intimate circles), ran algebraic geometry and set their mark on modern Dutch geometry. Murre stayed remarkably physically unchanged throughout his adult life, only slowing down at the very end. Mentally he was alert and active long beyond his 'best due date,' publishing, going to meetings, and never really losing his love for mathematics. His last years were saddened by the loss of relatives and old friends, and above all by the loss of his wife, with which much of his zest for life fizzled out; as incidentally was also the case of his old mentor Weil. He was felled by a short illness this past April at the age of ninety-four.

*Acknowledgements.* I am very much indebted to my friend Chris Peters, not only was his article on Murre very helpful to me, he also carefully read the first draft of this obituary and saved me from more than one blunder, and inspired some additional comments. For those able to decipher Dutch I recommend the transcript of the interview with Murre conducted by Chris and his wife Annie.<sup>7</sup>

---

Ulf Persson is professor emeritus of Chalmers University of Technology since 2017. He has been an editor of the EMS Magazine (formerly Newsletter) since many years, as well as running the Newsletter of the Swedish Mathematical Society. His mathematical field is algebraic geometry and his field of specialization, algebraic surfaces.

[ulfp@chalmers.se](mailto:ulfp@chalmers.se)

---

<sup>6</sup> *Nieuw Arch. Wiskd.* (5) 24, 177–186 (2023)

<sup>7</sup> <https://www-fourier.univ-grenoble-alpes.fr/~peters/teachers/Interview-JM-0812.pdf>

---

<sup>5</sup> Lest anybody imagines that Murre was imposing himself, one should once again point out that he was the least likely of all mathematicians to impose himself, his modesty, as noted, being legendary.

# ERME column

regularly presented by Frode Rønning and Andreas Stylianides

In this issue, with a brief report from CERME13 and a presentation of the Thematic Working Group on Mathematics Teaching and Teacher Practice(s), TWG19, by the group leaders Reidar Mosvold, Mark Hoover, Helena Grundén, Siún Nic Mhuirí and Chrysoula Choutou

## CERME13

The 13th Congress of the European Society for Research in Mathematics Education, CERME13, was held at the Eötvös Loránd University, Budapest, Hungary, on 10–14 July 2023.<sup>1</sup> The CERMEs are usually held in February, but due to uncertainties regarding the Covid situation at the time of decision, it was decided to hold the congress in the summer.

A total of 941 participants from 54 countries attended CERME13, distributed over 27 Thematic Working Groups (TWGs). A record 616 papers and 141 posters were accepted and presented. Two plenary lectures were delivered: Berta Barquero from the University of Barcelona, Spain, gave a lecture titled *Mathematical modelling as a research field: Transposition challenges and future directions*, and László Lovász from Hungary, an Abel Prize laureate,<sup>2</sup> gave a lecture with the title *Why is mathematics beautiful?* Finally, a plenary panel around the topic of *Bridging the research-practice gap*, was chaired by João Pedro da Ponte (Portugal).

The first CERME was held 35 years ago, in 1998, and attracted 120 participants from 24 countries. The growth in the number of participants shows that CERME enjoys wide attraction, both in Europe and beyond, but it has now come to a point where further growth is neither feasible nor desirable.

From CERME14, the congress will be back on track as regards time of the year, as it will be held on 4–8 February 2025, at the Free University of Bozen-Bolzano, Italy. This university also arranged the virtual CERME12 in 2022 and will now have the opportunity to host a real, on-site conference.

## CERME Thematic Working Groups

We continue the initiative of introducing the CERME Thematic Working Groups, which we began in the September 2017 issue, focusing on ways in which European research in the field of mathematics education may be interesting or relevant for people working

in pure and applied mathematics. Our aim is to disseminate developments in mathematics education research discussed at CERMEs and enrich the ERME community with new participants, who may benefit from hearing about research methods and findings and contribute to future CERMEs.

## CERME Thematic Working Group 19: Mathematics Teaching and Teacher Practice(s)

### Introduction

Research on mathematics teaching, whether in elementary schools, high schools, or universities, has a long history, but the emphasis in research on teaching has shifted over the decades. Often the focus has been on teachers, classrooms, and their characteristics, rather than on teaching as an activity itself. When teaching has been in focus, it has been thought about in different ways. In the first *Handbook of Research on Teaching*, Henderson [3, p. 1007] described teaching in mathematical terms: “ $x$  teaches  $y$  to  $z$ ,” and he proposed that teacher behavior – what teachers do – was the most significant factor for research on mathematics teaching. Teacher behavior could, and perhaps should, focus on the interactions between teacher ( $x$ ) and students ( $z$ ) around some content ( $y$ ), but early research on teaching developed an emphasis on simple, measurable behaviors with little regard for content or reflective practice.

Then, after several decades of research on teacher behavior, Shulman [4] claimed that the role of content had become a missing paradigm in research on teaching. Following Shulman, researchers in the field shifted attention to content knowledge for teaching mathematics. This shift resulted in studies that attempted to understand and measure *teachers’ knowledge*. Some studies of teachers’ knowledge draw on a cognitive perspective, highlighting teachers’ thinking and cognition, whereas other studies emphasize what mathematical knowledge teachers need, or ought to have. However, Ball and colleagues offer a practice-based focus on what it means to know and do mathematics in and for teaching [1]. Such a shift requires considering teaching as work to be done, where this work involves certain entailments or demands that teachers

<sup>1</sup> <https://cerme13.renyi.hu>

<sup>2</sup> <https://abelprize.no/abel-prize-laureates/2021>



face. More recently, there has been increased focus on the social, cultural, and political aspects of mathematics teaching. Aguirre et al. [2] argue that some research has moved beyond sociocultural views and suggests a sociopolitical turn, which means that issues such as equity, identity and power are at play in research on mathematics teaching and learning.

Across this historical development, three underlying conceptions of teaching can be identified in research on teaching. Mathematics teaching can be considered as:

- What teachers *do*.
- What teachers *should or ought to do* (or know).
- *Work to be done*.

Thematic Working Group (TWG) 19 seeks to navigate these trends and underlying conceptions in efforts to study mathematics teaching, from preschool to graduate school.

### History of the TWG

Ever since the first CERME conference in 1998, our TWG was part of a group that was called *From a Study of Teaching Practices to Issues in Teacher Education*. This group existed for several years, before it split up into three groups at CERME8. One of the new groups emphasized teacher education and professional development, and another group targeted teacher knowledge, beliefs, and identity. TWG19 was initially called *Mathematics Teacher and Classroom Practices*, but after CERME10, the name was changed to *Mathematics Teaching and Teacher Practice(s)*. This change of name was meant to signal that the primary emphasis was on *teaching*, and not on *teachers*. It was also meant to clarify that the emphasis was on *teacher practice(s)*, and not on any practices that might occur in classrooms.

In tandem with this change of name, we recognized – and started to explicitly address – some key challenges. Unlike research on mathematical learning, research on mathematics teaching does not have any grand theory. Instead, researchers have developed diverse frameworks, conceptions, theories, and methods – many of which are left implicit. Managing this diversity has been challenging. As a community, we felt a need to develop common frames or conceptions, or at least find ways to more explicitly discuss the diversity. Without shared language and meanings, it was difficult to understand each other's research.

### Current efforts

In the past few conferences, TWG19 has initiated responses to these challenges. First, we have made efforts to collaboratively explore the meaning of teaching. We have asked participants to be explicit about what they mean by “teaching” in their papers, we have facilitated discussions of the meanings of teaching across papers at the conferences, and we have explored distinctions in the meaning of teaching in different studies. Second, we have

proposed four analytic domains as a way of identifying the primary focus in studies on mathematics teaching. Participants have been encouraged to consider their own work in relation to one of the following domains:

1. Consideration of mathematics and the central endeavor of extending the subject to students.
2. Becoming acquainted with, relating to, and responding to students as people and learners.
3. Organization and enactment of design, interaction, and discourse of teaching and learning.
4. Attending to broader social, cultural, and political issues that matter for teaching and learning, including imperatives of social justice.

Third, we have offered sets of shared data and invited participants to use these data sets in their papers and presentations. As a result, several papers have applied different lenses to analyze these common data sets, and all participants in the group have been given access to these data sets to provide a common ground for discussions.

### Conclusion

Although the challenges in research on mathematics teaching have not been resolved, we have experienced TWG19 as a productive arena for discussing and developing research in this field. The four domains draw on a conception of teaching as instructional interactions between teachers and students around some mathematical content within some particular environment (adding an important contextual factor to the original set of variables proposed by Henderson). The five domains have helped us to be more explicit about what we mean by teaching and have stimulated discussion of how different conceptions communicate with each other. Additionally, the shared data initiative continues to provide a common ground for exploring and discussing mathematics teaching. In this work, the perspectives of mathematics and mathematicians continue to be important, as the mathematical issues at play, whether in teaching young children or adults, are surprisingly subtle and deep. We welcome broad engagement in the study of mathematics teaching. More than just encouraging it, we see it as essential to growing understanding and improving practice.

### References

- [1] D. L. Ball, [Uncovering the special mathematical work of teaching](#). In *Proceedings of the 13th International Congress on Mathematical Education: ICME-13*, pp. 11–34, Springer, Cham (2017)
- [2] J. Aguirre, B. Herbel-Eisenmann, S. Celedón-Pattichis, M. Civil, T. Wilkerson, M. Stephan, S. Pape, and D. H. Clements, [Equity within mathematics education research as a political act: Moving from choice to intentional collective professional responsibility](#). *J. Res. Math. Educ.* **48**, 124–147 (2017)

- [3] K. B. Henderson, Research on teaching secondary school mathematics. In *Handbook of Research on Teaching*, pp. 1007–1030, Rand McNally & Company, Chicago, IL (1963)
- [4] L. S. Shulman, *Those who understand: Knowledge growth in teaching*. *Educational Researcher* 15, 4–14, (1986)

---

Reidar Mosvold is a professor of mathematics education at the University of Stavanger. He enjoys being involved with research and development of mathematics teaching. His research interests focus on the work of leading mathematical discussions, what it means to be smart in mathematics, and methods for studying mathematics teaching.

[reidar.mosvold@uis.no](mailto:reidar.mosvold@uis.no)

Mark Hoover is a research scientist at the University of Michigan. He is concerned with personal and professional relationships in the presence of power. His research investigates the work entailed in mathematics teaching, extending to teaching and teacher education across subject areas, the subject-matter work of teaching, and conceptual-analytic methods for studying teaching.

[mhoover@umich.edu](mailto:mhoover@umich.edu)

Helena Grundén is deputy head of school, teacher educator, and researcher at the Dalarna University in Sweden. Her research interests include planning in mathematics teaching as well as social and structural issues that relate to mathematics education.

[hgn@du.se](mailto:hgn@du.se)

Siún Nic Mhuirí is an assistant professor of mathematics education in the Institute of Education, Dublin City University. She is interested in the agency and authority of teachers and students. Her research investigates the role of talk in classroom practice, and the design of initial and continuing teacher education.

[siun.nicmhuiri@dcu.ie](mailto:siun.nicmhuiri@dcu.ie)

Chrysoula Choutou holds a PhD in mathematics education from the National and Kapodistrian University of Athens. Her research centers on investigating the connections between mathematics and visual arts in teaching and learning, and how secondary school mathematics teachers can integrate visual arts into their teaching through collaboration with visual art teachers.

[chrychou@math.uoa.gr](mailto:chrychou@math.uoa.gr)

## EMS Press title

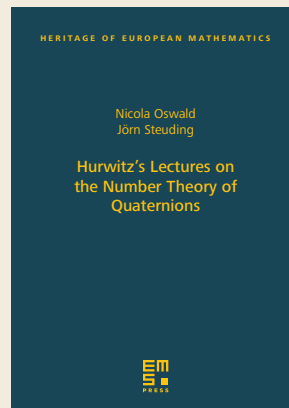

### Hurwitz's Lectures on the Number Theory of Quaternions

Nicola Oswald  
(Bergische Universität Wuppertal)  
Jörn Steuding  
(Julius-Maximilians Universität Würzburg)

Heritage of European Mathematics

ISBN 978-3-98547-011-2

eISBN 978-3-98547-511-7

2023. Hardcover. 311 pages.  
€79.00\*

Quaternions are non-commutative generalizations of the complex numbers, invented by William Rowan Hamilton in 1843. Their number-theoretical aspects were first investigated by Rudolf Lipschitz in the 1880s, and, in a streamlined form, by Adolf Hurwitz in 1896.

This book contains an English translation of his 1919 textbook on this topic as well as his famous 1-2-3-4 theorem on composition algebras. In addition, the reader can find commentaries that shed historical light on the development of this number theory of quaternions, for example, the classical preparatory works (of Fermat, Euler, Lagrange and Gauss to name but a few), the different notions of quaternion integers in the works of Lipschitz and Hurwitz, analogies to the theory of algebraic numbers, and the further development (including Dickson's work in particular).

*\*20% discount on any book purchases for individual members of the EMS, member societies or societies with a reciprocity agreement when ordering directly from EMS Press.*

EMS Press is an imprint of the European Mathematical Society – EMS – Publishing House GmbH  
Straße des 17. Juni 136 | 10623 Berlin | Germany  
<https://ems.press> | [orders@ems.press](mailto:orders@ems.press)



ADVERTISEMENT

# ICMI Column

Núria Planas

## Mathematics education for humanity in the work of ICMI

### Introduction

For decades, in the community of mathematics educators, we have been discussing moves from ‘mathematics’ and ‘education’ to ‘mathematics education,’ alongside the relative distances between ‘mathematics’ and ‘mathematics education,’ and between ‘education’ and ‘mathematics education.’ Today, we know that there are also questions about the relative distance between ‘mathematics education’ and ‘humanity.’ For instance, what mathematics education aspects might be unrelated to humanity, that is, unrelated to the challenges that humanity faces, including helping people act in ways that are humanitarian?

Even if the role of mathematics education in the present and future is undeniable, a question is, therefore, mathematics education for what? In the work of the International Commission on Mathematical Instruction (ICMI), the importance of mathematics education for humanity remains a continuing invariant. The ICMI work is in this sense a strong instance of the relationship between ‘mathematics education’ and ‘humanity.’ A global understanding of mathematics education confronted with challenges that range from alleviating suffering and lessening vulnerability to reducing social, economic and environmental risk, in the spirit of the Universal Declaration of Human Rights [12], adds value to a diversity of ICMI initiatives.

In this brief text, I develop the argument of the relationship between ‘mathematics education’ and ‘humanity’ in the work of ICMI with a focus on the most present times. I choose the following four lines of evidence: (1) the scientific program of the 15th International Congress on Mathematical Education (ICME), (2) the launch of ICMI Study 27 “Mathematics Education and the Socio-Ecological,” (3) the ICMI’s second and seventh Felix Klein Medals to Professors Ubiratan D’Ambrosio and Alan Bishop, and (4) the creation and enactment of the Capacity and Networking Project (CANP).

The interest of ICMI in issues of mathematics education for humanity, and the question of mathematics education for what, certainly parallels the interest of the International Mathematics Union

(IMU) in issues of mathematics for humanity, and the question of mathematics for what. Christiane Rousseau, at the time of her IMU vice-presidency, wrote a beautiful editorial for the IMU Newsletter [10] about the role of mathematics as a powerful tool for issues of sustainable development in its three dimensions: social, economic and environmental. Recently, IMU signed the commitment with the 2024–2033 International Decade of Sciences for Sustainable Development [11, 13]. For the case of mathematics for humanity and IMU, thus, several lines of evidence could also be detailed. Moreover, for both ICMI and IMU, a basic premise is the solid link between goals of sustainable development and goals of humanity. Sustainable development demands are viewed as necessarily having humanitarian connotations and consequences, and vice versa.

### First line of evidence

ICME is the major international conference in mathematics education. The next meeting, ICME-15, will take place this coming summer in Sidney, Australia, from 7 to 14 July. In the detailed program of ICME-15,<sup>1</sup> some primary emphases are on the function of mathematics education to achieve healthier and more equitable societies. A considerable number of plenary and parallel activities are aimed at encouraging mathematics educators to relate the field of knowledge with issues for humanity and sustainable development. The theme and description for the plenary panel 1 reads as follows:

*Mathematics education effectively responds to humanity’s problems: Panelists will explore the interaction between mathematics education and issues of enormous importance to society, such as climate change, pandemics, international conflicts, and ongoing inequities. What role, if any, should mathematics education play beyond ensuring that countries have mathematical literate citizens? What are the ethical and practical challenges?<sup>2</sup>*

<sup>1</sup> Available on the Congress website: <https://icme15.org>.

<sup>2</sup> <https://icme15.org/icme-15-scientific-program/icme-15-plenary-events>

The list of “possible topics for discussion groups” includes:

*Climate change and sustainability; Social justice, poverty, and inequality; Citizenship, democracy, and fake news; Displaced people, peace, and justice; Indigenous knowledges and decolonising mathematics; Contemporary gender issues (transgender, gender diversity etc.); Artificial Intelligence; Pandemics, wellbeing, and resilience.*<sup>3</sup>

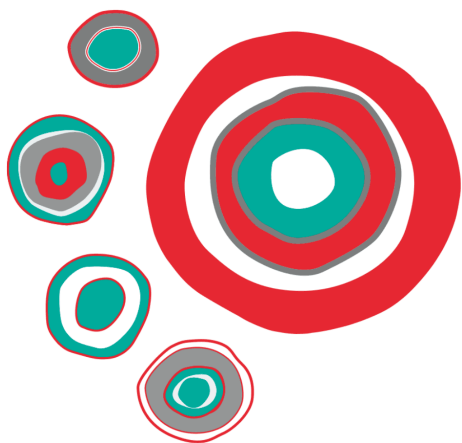

Figure 1. The ICME-15 logo.  
(Design by Saretta Fielding, from the Wonnarua Nation.)

The ICME-15 logo<sup>4</sup> provides more emphases on mathematics education for alleviating suffering, reducing risk and lessening vulnerability. In this logo (see Figure 1), the large circle represents the importance of mathematics in everyday lives, and the smaller circles represent delegates from around the world, depicted as stepping-stones that provide the ability to expand our knowledge. The logo design and its explanation acknowledge the First Nations people, including teachers and learners of mathematics whose mathematical knowledge, languages and cultures have historically been marginalized in Australian mathematics schools and throughout the world. This acknowledgment particularly recognizes the mathematical practices in the rural and remote communities, also documented by research in mathematics education conducted in collaboration with these communities (see, e.g., the sophisticated large-scale spatial representations of the peoples in the northwestern Kimberley region discussed in [7]).

More generally, through a diversified collection of Topic Study Groups (TSGs) in ICMEs, ICMI work aligns itself with the humanizing mission of the mathematics that is taught for the inclu-

sion of all learners. As a regular participant of TSGs on aspects of mathematics education and language, for example, I am impressed by how much attention several international colleagues pay to the linguistic use of the passive voice and nominalized forms in classroom teaching practices [9]. Human agency is very differently constructed in  $(x + y) \cdot (x - y)$  is easily seen to be equivalent to  $x^2 - y^2$ , compared to *We can easily see the equivalence between  $(x + y) \cdot (x - y)$  and  $x^2 - y^2$* . As discussed in other TSGs with a focus on aspects of argumentation, human agency is also very differently constructed if mathematics teaching is aimed at designing and creating a strong inquiry-oriented environment for the promotion of all learners’ mathematical reasoning and positive identities as problem thinkers [4]. This humanizing mission also crosses the diversified collection of ICMI Studies.

### Second line of evidence

The ICMI Studies<sup>5</sup> constitute a major ICMI program with significant influence on the field of mathematics education. The very last ICMI Study launched in 2023 is “Mathematics Education and the Socio-Ecological,” with Kate le Roux, University of Cape Town, South Africa, and Alf Coles, University of Bristol, UK, as co-chairs. The Discussion Document of the ICMI Study 27 is already finalized and disseminated internationally in 2024, alongside the call for the Study Conference in Quezon City, Philippines in January 2025, all this aiming at the final production of the Study Volume.<sup>6</sup> Moreover, we have available the pre-conference proceedings of the preparatory ICMI Symposium on Mathematics Education and the Socio-Ecological,<sup>7</sup> held online on 20 March 2023. As written in the September 2023 ICMI Newsletter [6], this ICMI Study will highlight three aims:

- (1) to gather state-of-the-art scholarship in socio-ecological mathematics education around the world and to engage in across-perspective dialogues;
- (2) to explore the different ways in which a theorization of the socio-ecological influences the focus and methodological approaches of mathematics education research; and
- (3) to provide insight into the practical implications of socio-ecological research associated with the mathematics curriculum, pedagogy, teacher preparation and education-related policies, beyond traditional approaches.

<sup>5</sup> <https://www.mathunion.org/icmi/activities/icmi-studies-activities>

<sup>6</sup> <https://www.mathunion.org/icmi/activities/icmi-studies/ongoing-icmi-studies>

<sup>7</sup> <https://www.mathunion.org/fileadmin/ICMI/Conferences/Socio%20Ecological/Proceedings-ICMI-symposium-20th-march-2023.pdf>

<sup>3</sup> <https://icme15.org/icme-15-scientific-program/discussion-groups>

<sup>4</sup> <https://icme15.org/first-nations-australians>

The meaning of the phrases socio-ecological and socio-ecology in relation to mathematics education is not trivial. In a conference talk, Coles referred to the relevance of ecological and socio-political issues for the mathematics education practices, and to the responsibility of mathematics teaching and education in response to the ecological and socio-political needs of our world. The extract below is from the written version of the talk, at the 46th Conference of the International Group for the Psychology of Mathematics Education (IGPME), one of the several ICMI Affiliate Organizations. Mathematics education for global sustainability was precisely the theme of the conference.

*The phrase “socio-ecology” points to the need for combining socio-political and ecological concerns. In this plenary talk, I consider what the socio-ecological means for mathematics education and what responsibility mathematics education has towards the socio-ecological. I review my own past research on “what” we teach and “how” we teach it, in relation to socio-ecological concerns and propose eight themes. These themes include: questioning what gets centred in our work; moving towards a communal mathematics; engaging in a dialogic ethics; working against the epistemological “error” of focusing on the individual as the unit of learning.* [2, p. 17]

Although the 27th ICMI Study is explicitly underpinned by a humanizing mission of mathematics and mathematics education, it is not the only ICMI Study with such a view. Gender and Mathematics Education (ICMI Study 7) and Educational Interfaces between Mathematics and Industry (ICMI Study 20) are just two examples. ICMI is funding the open access publication of the volumes of its ICMI Studies and, in this way, making their content progressively available to anyone all over the world,<sup>8</sup> which is again a proof of the commitment to global service and scholarship. How funds are used is certainly important and informative. Since ICME-8, the ICMEs Solidarity Fund provides grants to people from less affluent regions of the world to support more diverse participation in the congresses.

### Third line of evidence

The ICMI Awards<sup>9</sup> pay tribute to outstanding scholarship and achievement in mathematics education. All awardees represent together the broad range of endeavors and emphases that characterize mathematics education research and practice. In the history of the ICMI Awards, two mathematics education researchers have particularly been selected for their contributions and ideas regard-

ing mathematical and mathematics education practices for bringing dignified human dimensions into relations between individuals, societies and cultures. Professor Ubiratan D’Ambrosio, from Brazil, was honored with the 2005 Felix Klein Award. “Socio-cultural bases for mathematical education” was the title of his pioneering talk at ICME-5 in 1984, in which he discussed critical meanings of mathematics for all and the place of mathematics education in societies [3]. The citation published for the ICMI distinction indicates the role of D’Ambrosio:

*In the development of research perspectives which are sensitive to the characteristics of social, cultural, and historical contexts in which the teaching and learning of mathematics take place, as well as his insistence on providing quality mathematics education to all, not just to a privileged segment of society.*<sup>10</sup>

Ten years later, Professor Alan Bishop, from UK and Australia, was honored with the 2015 Felix Klein Award. Bishop’s work puts at the center the discussion of whether and how values interact with mathematics teaching and learning. Not only is his book titled “Mathematical Enculturation: A Cultural Perspective on Mathematics Education” [1] a milestone in the field, but he was also a founder of the Mathematics Education and Society (MES) community,<sup>11</sup> which gave rise to the associated conferences on the political and social dimensions of mathematics education. At ICME-6 in 1988, Bishop co-organized a special one-day event that would lead to create the MES community. The citation published for this distinction indicates Bishop’s ground-breaking contributions to:

*The notion of mathematics as a cultural product and the cultural values that mathematics embodies ... bringing the political, social, and cultural dimensions of mathematics education to the attention of the field. ... “Alan is an excellent scholar and researcher who has shaped our field not only over his lifetime but also over its lifetime...”*<sup>12</sup>

It is of course unfair not to mention many other, if not all, ICMI medalists throughout these decades. My conversations with Celia Hoyles, for example, during her 2023 stay in Barcelona for the preparation of the last module of her ICMI AMOR Unit (read about AMOR in [8]) showed her genuine interest in the mathematical learning and strengths of all groups of learners, alongside

<sup>10</sup> <https://www.mathunion.org/icmi/awards/past-receipients/2005-felix-klein-award>

<sup>11</sup> <https://www.mescommunity.info>

<sup>12</sup> <https://www.mathunion.org/icmi/awards/past-receipients/2015-felix-klein-award>

<sup>8</sup> <https://www.springer.com/series/6351/books>

<sup>9</sup> <https://www.mathunion.org/icmi/awards/icmi-awards>

a genuine enthusiasm and trust in the generous vision of teams of mathematics educators and teachers across the world.

#### Fourth line of evidence

The Capacity and Network Project (CANP)<sup>13</sup> is one more expression of the humanizing mission of ICMI. CANP has been a major investment of ICMI in the last decade, devoted to enhancing mathematics education at all levels in the so-called developing countries and regions so that their people are capable of meeting challenges of mathematics teaching and learning, teacher education, and professional development. The process of this ICMI project, starting in 2011, is a journey of teamwork and change involving series of programs towards the common goal of making high quality mathematics education available to all, including the people of low-income and lower-middle-income countries in five world regions shortly named as CANPs: Sub-Saharan Africa, East Africa, Central America and the Caribbean, South-East Asia, and Andean Region and Paraguay. Each CANP has a loosely structured governance mechanism supported by at least two regional representatives and one member from the ICMI Executive Committee, who serves as a liaison and principal contact.

CANP has proven successful and vibrant regional communities are emerging out of this process. As explained by the vice-president of ICMI who currently provides the general coordination of all the CANPs, Anjum Halai, there are also many challenges and future directions to be explored in the coming period:

*The community of mathematics educators across the five CANPs is a significant resource because working at the grassroots level they provide insights into key issues and challenges in promoting mathematics education. ... CANP could support the local efforts to become part of the wider international mathematics education community by helping local activity aspire to international standards of quality, and by supporting international dissemination findings. [5, p. 45].*

One more dimension of the ICMI work is therefore concerned with the inequalities in development between developed and developing regions. This is another important and informative way of how the funds of ICMI are used for the benefit of its humanizing mission. The CANP regional communities are collaboratively managed or guided by different professionals of mathematics education and mathematics such as school teachers, university researchers, teacher educators and representatives of educational authorities. These communities are free to make decisions and take actions

within their local contexts that support the development and sustainability of the educational capacity of those responsible for mathematics education. Far from devaluing the complexity and diversity of each region by importing mainstream approaches, the CANP project is highly respectful with the knowledge, ideas and experiences of the people in the community.

#### Final remark

I could not include as many lines of evidence as I would have wished for my argument on the relationship between 'mathematics education' and 'humanity' in the work of ICMI, in this brief text. I apologize because I have inevitably overlooked ICMI initiatives and mathematics educators. Regardless, I encourage you to join some of the ICMI initiatives around mathematics education for humanity by participating in ICME-15 and by contributing to the ICMI Study 27. You can also enjoy and learn from watching the Introductory Module of the ICMI AMOR Unit devoted to Ubiratan D'Ambrosio.<sup>14</sup> Humanity and humility have the same linguistic root, as Ubiratan D'Ambrosio used to remind us. This closeness may be helpful for adopting the Copernican-type principle that all humans deserve the same privileged position in the universe of mathematics education!

#### References

- [1] A. J. Bishop, *Mathematical enculturation: A cultural perspective on mathematics education*. Kluwer, Dordrecht (1988)
- [2] A. Coles, Teaching in the new climatic regime: Steps to a socio-ecology of mathematics education. In *Proceedings of the 46th Conference of the International Group for the Psychology of Mathematics Education*, Vol. 1, pp. 17–33, University of Haifa, Israel (2023)
- [3] U. D'Ambrosio, *Socio-cultural bases for mathematical education*. In *Proceedings of the Fifth International Congress on Mathematical Education*, pp. 1–6, Birkhäuser, Boston, MA (1985)
- [4] T. Dreyfus, The interplay between construction of knowledge by individuals and collective mathematical progress in inquiry-oriented classrooms. In *Proceedings of the 14th International Congress on Mathematical Education*, Vol. 1, 7 pp., World Scientific, Singapore, Shanghai (2024)
- [5] A. Halai, *ICMI column: Professional learning networks in mathematics education*. *Eur. Math. Soc. Mag.* 129, 44–46 (2023)
- [6] F. Leung, Launching the 27th ICMI Study on Mathematics Education and the Socio-Ecological. *ICMI Newsletter*, September (2023)<sup>15</sup>

<sup>13</sup> <https://www.mathunion.org/icmi/activities/developing-countries-support-and-canp/capacity-networking-project-canp>

<sup>14</sup> <https://www.mathunion.org/icmi/awards/amor/ubiratan-dambrosio-unit>

<sup>15</sup> <https://www.mathunion.org/icmi/icmi-newsletter-september-2023#on-page-9>

- [7] T. Lowrie, R. Jorgensen, T. Logan and D. Harris, *Culture and geography: How do primary students map their local environment?* *The Australian Educational Researcher* **49**, 261–284 (2022)
- [8] N. Planas, *ICMI AMOR: A collective long-term project with short-term opportunities*. *Eur. Math. Soc. Mag.* **124**, 57–56 (2022)
- [9] N. Planas, Arguments or findings regarding language as resource for mathematics learning and teaching. In *Proceedings of the 14th International Congress on Mathematical Education*, Vol. II, 16 pp., World Scientific, Singapore, Shanghai (2024)
- [10] Ch. Rousseau, Editorial. *IMU-Net* **47**, May (2011)<sup>16</sup>
- [11] Ch. Sorger, Proclamation of the 2024–2033 International Decade of Sciences for Sustainable Development by the UN General Assembly. *IMU News* **121**, September (2023)<sup>17</sup>
- [12] United Nations General Assembly, *Universal declaration of human rights*. UN (1948)<sup>18</sup>
- [13] United Nations General Assembly, *International decade of sciences for sustainable development, 2024–2033*. UN (2023)<sup>19</sup>

---

Núria Planas is professor of mathematics education at Autonomous University of Barcelona, Spain, and honorary research fellow at the Department of Education at the University of Oxford. Her research and publications focus on multilingual mathematics learning and teaching, professional development of secondary-school mathematics teachers on issues of linguistic responsiveness in mathematics teaching, and sociocultural theories of mathematics education. She is a member-at-large of the ICMI Executive Committee.

[nuria.planas@uab.cat](mailto:nuria.planas@uab.cat)

## L'Enseignement Mathématique

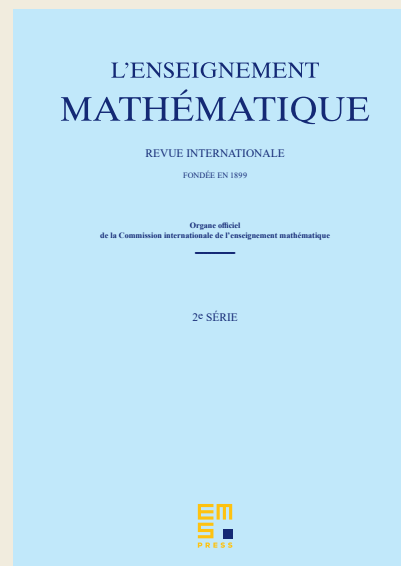

All issues of Volume 69 (2023) are accessible as open access under EMS Press' *Subscribe to Open* programme.

[ems.press/lem](https://ems.press/lem)

Official organ of the International Commission on Mathematical Instruction.

*L'Enseignement Mathématique* was founded in 1899 by Henri Fehr (Geneva) and Charles-Ange Laisant (Paris). It is intended primarily for publication of high-quality research and expository papers in mathematics.

Managing Editor:

Anders Karlsson (Université de Genève)

Editors:

Anton Alekseev, Jérémy Blanc, David Cimasoni, Pierre de la Harpe, Antti Knowles, Emmanuel Kowalski, Nicolas Monod, Tatiana Smirnova-Nagnibeda, John Steinig<sup>†</sup>, András Szenes

For more details visit [ems.press/lem](https://ems.press/lem)

EMS Press is an imprint of the European Mathematical Society – EMS – Publishing House GmbH  
 Straße des 17. Juni 136 | 10623 Berlin | Germany  
<https://ems.press> | [subscriptions@ems.press](mailto:subscriptions@ems.press)



<sup>16</sup> <https://www.mathunion.org/imu-net/archive/2011/imu-net-047>

<sup>17</sup> <https://www.mathunion.org/imu-news/archive/2023/imu-news-121-september-2023#on-page-4>

<sup>18</sup> <https://digitallibrary.un.org/record/666853>

<sup>19</sup> <https://digitallibrary.un.org/record/4019134>

# The extension of zbMATH Open by arXiv preprints

Isabel Beckenbach, Klaus Hulek and Olaf Teschke

*zbMATH Open has started a new feature – relevant preprints posted at arXiv will also be displayed in the database. In this article we introduce this new feature and the underlying editorial policy. We also describe some of the technical issues involved and discuss the challenges this presents for future developments.*

## 1 Introduction

During the last three decades, arXiv has established itself as the main preprint repository for mathematics. Some years ago, in [6, 7], we analysed the share of publications in the zbMATH corpus available via arXiv versions. There we saw that, despite a very uneven distribution depending on the mathematical subjects, the share of arXiv coverage has been growing constantly. Today, the overall arXiv share exceeds a third of all recent mathematical publications, with the figures for several core areas of mathematics being significantly higher, often exceeding 50%. Moreover, the arXiv share is still growing, although some saturation effects can already be observed in certain areas (e.g., the percentage of about 80% of publications in algebraic geometry available on arXiv has not improved much recently). zbMATH Open has adapted its services to this situation, and has been providing links from published documents to available arXiv versions for more than ten years now. Obviously, this required a precise matching algorithm, taking into account the information provided by arXiv. This information, however, is somewhat unstable. It may vary with submission versions, and the citable source strings contain less information than the ones from published journals. Indeed, our success in matching zbMATH Open entries to arXiv versions has much improved since we started linking to it, and the figures (as evaluated on test sets definable by DOIs) now indicate a very mature state (see Section 4).

One obvious advantage is that this ensures the open availability of a significant share of mathematics research – indeed, despite the growing ecosystem of open and hybrid journals, platforms, and transitory deals, arXiv accounts by far for the largest share of mathematics publications available through open access [3]. But the advantages achieved through this matching go much beyond

findability and access. Namely, this also opens up the path for numerous new investigations and thus new insights. Just to give an example: the links now serve as a proxy to estimate the time between submission and publication in various mathematical areas [1, 2, 5].

Especially the long period between submission and publication in many core mathematical areas, predominantly caused by a thorough peer review process, raises natural questions about the difference set: how large is the *unpublished* share of arXiv in mathematics? What are the chances of arXiv submissions to be finally published? And, perhaps most importantly, would it not be beneficial for a comprehensive information system in mathematics to integrate a well-defined subset of arXiv into zbMATH Open? In particular, it could serve to enhance the visibility of recent work, especially by young researchers whose career chances suffer from long publication delays. If so, how should one formulate a sound indexing policy that matches closely the zbMATH Open scope despite the lack of a formal peer review process at arXiv?

There can be few doubts about the relevance of unpublished arXiv preprints. Not just the share of the platform in recent work, but also the omnipresence of unpublished arXiv submissions in the references of already published documents underline its significance. So the principal decision to enlarge the information available in zbMATH Open by unpublished arXiv preprints was a very natural one. However, the exact realisation details are very involved. In this column we outline the editorial policies and the new features that define the arXiv subset now integrated into zbMATH Open.

## 2 The editorial policy

### 2.1 Aims and resulting editorial decisions

The scope of zbMATH Open, as defined by its editorial policy, has been to index “all available published and peer-reviewed articles, books, conference proceedings as well as other publication formats pertaining to the scope given above that present a genuinely new point of view”.<sup>1</sup> This allows different interpretations

<sup>1</sup> [https://zbmath.org/about/#id\\_1\\_1](https://zbmath.org/about/#id_1_1)



and is subject to the dynamics of the field and its publication system. Nevertheless, the consistency of this approach has been ensured by the editorial board, the expert staff covering the diverse mathematical subjects, the ongoing maintenance and development of the applied classification system,<sup>2</sup> and the supervisory boards.

Unpublished arXiv preprints per se do not satisfy all conditions of the above definition. There is no refereeing process for arXiv, although a mature mediator and endorsement system is installed to ensure both the scientific relevance and formal standards of the accepted submissions. The first and foremost condition for integrating unpublished arXiv preprints into zbMATH Open must be that they are clearly distinguishable from published work. This now happens at two different levels: firstly as a new database type ('arXiv', in addition to Zbl, JFM, and ERAM); secondly as a new document type ('Preprints', in addition to books, and journal and collection articles). Filtering with both facets will currently provide identical results, although this may change with future developments (Figure 1).

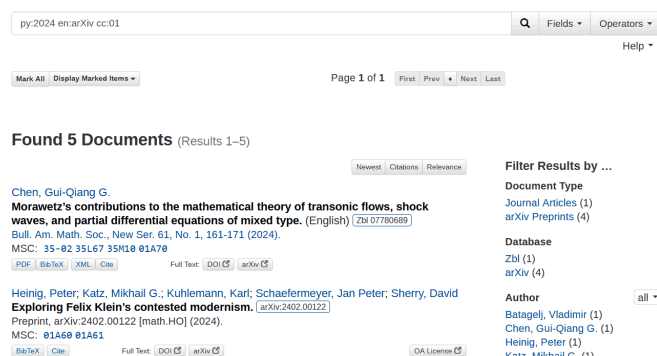

Figure 1. New filter functions allow to clearly distinguish additional unpublished arXiv entries.

Perhaps the most important distinction from classical zbMATH Open documents is that unpublished arXiv preprints will not be sent out for reviewing. This is due to the very nature of arXiv submissions – they are not stable versions, and may in fact vary significantly over time. To reflect this, they would require multiple reviews, which would both be beyond the resources of zbMATH Open and unsatisfactory for reviewers. Neither will there be multiple entries for (possibly quite different) arXiv versions, but only one, which is defined by the stable arXiv identifier – along with author and title information, the only metadata required for the entries. The preliminary nature is also reflected by the fact that, contrary to other new zbMATH Open entries, there will be no editorial classification – only MSCs already provided by authors will be

displayed. However, the entries *are* integrated into the zbMATH Open author disambiguation, to ensure that they are visible in the author profiles (more details are given below in Section 4.2).

Finally, once more emphasizing the preliminary nature of the arXiv entries, they will be merged with the stable version after publication. After that, the arXiv version will just appear as an additional link, precisely as it has been before the arXiv integration.

## 2.2 Defining the scope

While this approach aims at following both the perception of arXiv as a preprint repository and the user expectations, it also creates specific challenges to the scope definition. There are several possible errors which may not be completely ruled out, but whose effects need to be minimized. First, of course, matching errors may either create duplicates (in case of false negatives) or missing arXiv entries (for false positive matchings). As explained in Section 4.1, the zbMATH Open arXiv matcher is now sufficiently sophisticated to ensure that such effects are negligible. However, they cannot be completely ruled out – e.g., Saharon Shelah (the mathematician with most overall arXiv submissions) has submitted individual book chapters separately to arXiv, which – due to the lack of metadata – cannot be automatically matched to the review of the complete books in zbMATH Open.

Of course, there are also arXiv submissions which will, for a variety of reasons, never be published. In this case, the entries will remain forever in their incomplete form, and eventually form a group of permanent zbMATH Open entries which would not exist otherwise. However, as this reflects the reality of mathematical information, this should be considered an asset rather than a liability. It may also happen that arXiv submissions are published in a journal or conference outside the scope of zbMATH Open. In this case, the entry will, somewhat unsatisfactorily, likewise remain forever in its preliminary form – and, moreover, it may actually not fit very well into the zbMATH Open scope (as evidenced by its final publication venue). We aim to minimize both effects by choosing only a limited and carefully chosen arXiv subset for inclusion.

This may enlarge the risk to err in the other direction: excluding arXiv preprints, although their content would be relevant to zbMATH Open. Even when they become finally available through publication in a source indexed by zbMATH Open, the information is still missing for a significant length of time, and the authors concerned may feel unduly disadvantaged in comparison with other arXiv entries which were included. Obviously, there is no ideal solution to this dilemma. The only meaningful option is a thorough analysis of how much in the different arXiv categories and subcategories has actually been published within the zbMATH Open scope in the past, and then to define a practical threshold.

The arXiv math category has 32 subcategories currently in use (subcategories that are not in use anymore are irrelevant

<sup>2</sup> <https://msc2020.org>

to the question of which recent unpublished preprints should be included). Of these, 28 have an overlap of more than 60% with the zbMATH Open corpus, i.e., they have been published in sources indexed in zbMATH Open. Some subcategories even have a share of more than 70% of the zbMATH corpus, though the differences appear to be more correlated with different publication delays and publication behaviour than with actual scope differences.

The share for the categories math.GM (general mathematics), math.HO (history and overview) and math.IT is significantly lower, although for different reasons. math.GM and math.HO contain a relatively large amount of non-research mathematics (e.g., of educational nature), while math.IT has only been introduced in 2007 as an alias for the subject area information theory in computer science. For this reason it naturally contains numerous not primarily mathematical contributions.

The only borderline case turned out to be math.ST (which is an alias of statistics theory, stat.TH) with a share of about 50%, which mostly reflects the fact that it contains not just mathematical research in statistics but is also often cross-referenced from non-mathematical categories with descriptive statistical work. Although it is almost impossible to establish a perfect distinction here, further analysis showed that the overlap with the published mathematical research literature increases sufficiently if submissions cross-referenced from non-mathematical arXiv categories are excluded – so this is the criterion currently employed as the scope definition for math.ST. On the other hand, the overlap of mathematical physics (math-ph, or as an alias, math.MP) was sufficiently high to be included as a whole.

### 3 New features for the arXiv entries in zbMATH Open

#### 3.1 Extent of the newly added information

Given these premises, slightly more than 200,000 unpublished arXiv preprints have now been added to the database – a figure that is likely to grow in the future due to the overall publication growth. But this does not represent a stable corpus in itself, since documents will be both added (through new preprints) and removed (due to their publication). About 83,000 documents are (preliminarily) assigned Mathematical Subject Classification numbers as provided by the authors. This figure could be expanded by a rough automated classification based on arXiv subcategories and semantic information, but no final policy decision has yet been taken in this direction. In any case, given the preliminary nature of the documents, there will be no further intellectual classification before publication.

With current figures, combinatorics (about 10,000 items) is the largest area among the newly added preprints, followed by partial differential equations (8,700), number theory (8,600), probability theory (8,300) and algebraic geometry (8,200).

It turned out that also the abstracts could be converted without too many problems, and are thus also displayed along with the entries. This came as a surprise as, in principle, arXiv submissions are free in their  $\text{\LaTeX}$  definitions and do not necessarily fit into the zbMATH Open  $\text{\LaTeX}$  framework [8]. The inclusion of abstracts allows for more efficient searches and a more informative display for these items. The entries are also integrated into the zbMATH Open author disambiguation (see Section 4.2). On the other hand, there is currently no reference extraction, since the citations formats are highly non-standardized within arXiv. Moreover, references may also vary significantly between different arXiv versions of the same submission. Therefore, these citations are currently not integrated into the zbMATH Open citation database (but see also the discussion in Section 5).

#### 3.2 Features

As a result, the additional arXiv entries are now, with respect to most of their features, searchable and retrievable. The entries can be filtered by authors, submission year, or MSC subject (Figure 2).

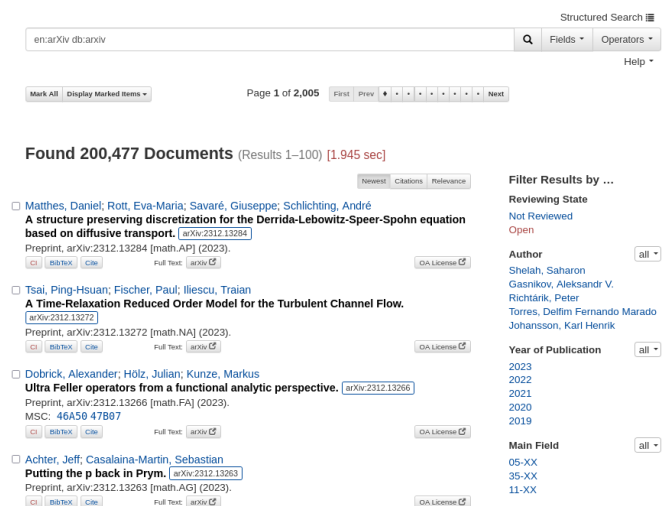

Figure 2. Filter functions for more than 200,000 newly added arXiv preprints.

Author signatures are linked to profile information, and the additional arXiv submissions are included into author profiles (Figure 3).

Another aspect is that, due to this addition, the share of open access documents available in zbMATH Open increased significantly, and approaches now about 1 million (i.e., >20%). Since these arXiv metadata are also included into the zbMATH Open APIs [4, 9], this creates additional opportunities for further research and infrastructure projects based on an open mathematics corpus.

## Tao, Terence

**Author ID:** tao.terence-c   
**Published as:** Tao, Terence; Tao, Terence C.; more...  
**Further Spellings:** Tao, Chi-Shen  
**Homepage:** <https://www.math.ucla.edu/~tao/>   
**External Links:** [MacTutor](#)  · [MGP](#)  · [ORCID](#)  · [Wikidata](#)  · [Google Scholar](#)  · [MathOverflow](#)   
· [Math-Net.Ru](#)  · [dblp](#)  · [GND](#)  · [IdRef](#)   
**Awards:** [Clay Research Award \(2003\)](#) · [Fields Medal \(2006\)](#) · [Breakthrough Prize in Mathematics \(2014\)](#)  
**Documents Indexed:** [406 Publications](#) since 1992, including [28 Books](#) and [40 Additional arXiv Preprints](#)  
[5 Contributions as Editor](#) · [3 Further Contributions](#)  
**Reviewing Activity:** [111 Reviews](#)  
**Biographic References:** [10 Publications](#)  
**Co-Authors:** [156 Co-Authors](#) with [258 Joint Publications](#)  
[4,914 Co-Co-Authors](#)

Figure 3. zbMATH author profiles with additional arXiv preprints.

## 4 Technical challenges and limitations

### 4.1 Matching

At a first glance it seems relatively easy to find a corresponding published version for an arXiv preprint. All one needs to do is to search for a document in zbMATH Open with the same title and author(s). Indeed, this approach leads to a lot of correct assignments. However, this will also miss a lot of matches as there is often a difference between the (latest) arXiv version and the published article indexed at zbMATH Open. The discrepancies include: different layout, numbering of theorems and sections, addition or deletion of content, or change of the title or abstract. Even the authors can differ in the published version. Thus, this naive matching approach would lead to a lot of duplicate entries after the arXiv integration. To avoid this problem, a precise matching procedure is needed. Our new approach is based on the DOI, title, authors and abstract of an arXiv article. It turns out that it has a higher accuracy as the naive comparison of title and authors.

Our matching algorithm has two steps. First, if an arXiv article has a DOI of a related published version given, then we search for an article with this DOI at zbMATH. If a unique article is found, we stop and return this article. Otherwise, a second matching step is executed, which is based on the title, author and abstract similarity. The idea behind this approach is that it might be that one value of those three types of metadata differs in the published version from the preprint, however, it is unlikely that all three differ simultaneously in a substantial manner.

In more detail, the second matching step works as follows. The title and authors of an arXiv preprint are used to search for a variable number of “candidate” zbMATH articles that might or might not match the input preprint. For each candidate, a three-dimensional vector is computed that contains the similarity of the title, authors and abstract of the candidate article to the input. Finally, a random forest classifier is used to decide whether a candidate matches or not. If more than one candidate matches, then the one with the lexicographic smallest similarity vector is returned

(the similarities are scaled to  $[0, 1]$  and a smaller number means higher similarity).

A disadvantage of our new approach, as compared to the naive one, is its higher complexity and that training data are needed to train the random forest classifier. The training data consists of pairs of correct arXiv, zbMATH matches which were generated using DOI-matching. This leads to some wrong pairs in the training data as the DOI given by arXiv or by zbMATH might be incorrect. Overall, the DOI information is very precise, so the training data is good enough to generate a random forest with a good performance. On some test data, which was also generated using DOI-matching, the classifier matching gives a precision of 99.51% and a recall of 96.89%.

Does our matching approach also make a difference in practice? In total our new two-step matching algorithm found 250,425 matches (14th December 2023). 73,567 of those come from the DOI matching (first step) and 176,858 from the classifier matching (second step). From the 176,858 classifier matches, 144,825 have exactly the same title and authors (after some normalization steps). Which means that our approach gives us 32,033 new matches compared to a naive comparison of title and authors.

### 4.2 Author disambiguation

The release of the zbMATH Open interface with the additional arXiv entries is also internally coupled with a new version of the automated author disambiguation. Beside slightly improved matching results, its main advantage is mostly invisible to the outside – its much more modularized structure was a prerequisite to handle both the new amount and somewhat different structure of the newly added items. Naturally, the assignments of arXiv preprints are somewhat less reliable than for the published corpus, due to the higher occurrence of metadata errors (e.g., in separating author names). Also, the unstable nature of arXiv entries must be handled appropriately in the assignment tables. Moreover, there is also the option that arXiv papers may be withdrawn – currently, we follow the arXiv policy that they are nevertheless still available (Figure 4).



The screenshot shows the arXiv interface for a withdrawn submission. The breadcrumb trail is "arXiv > math > arXiv:2310.18973". The search bar contains "math" and "arXiv:2310.18973". The page title is "Mathematics > Probability". A prominent message states: "This paper has been withdrawn by Minoru Yoshida". Below this, it says "[Submitted on 29 Oct 2023 (v1), last revised 18 Nov 2023 (this version, v2)]". The main title of the paper is "Homogenization of diffusions on the lattice  $\mathbb{Z}^d$  with periodic drift coefficients; Application of logarithmic Sobolev inequality". The authors listed are Sergio Albeverio, Michael Rockner, Simonetta Bernabei, and Minoru Yoshida. A short abstract follows: "A homogenization problem of infinite dimensional diffusion processes indexed by  $\mathbb{Z}^d$  having periodic drift coefficients is considered. By an application of the uniform ergodic theorem for infinite dimensional diffusion processes based on...". On the right side, there is an "Access Paper:" section with a "Withdrawn" status. Below that, it shows the current browse context as "math.PR" and navigation options like "< prev", "next >", "new", and "recent | 2310". There are also options to "Change to browse by: math" and "References & Citations" with links to NASA ADS, Google Scholar, and Semantic Scholar. At the bottom right, there are links for "Export BibTeX Citation" and "Bookmark".

Figure 4. A withdrawn arXiv submission with a separator error.

Author ID: viergever.anna-m   
 Further Spellings: Viergever, Anneloes  
 Documents Indexed: 2 Publications since 2023, including 2 arXiv Preprints  
 Reviewing Activity: 1 Review

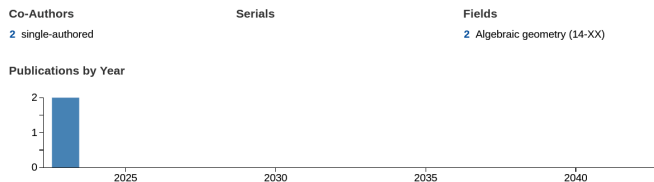

Figure 5. A new author profile based on arXiv submissions.

Perhaps most importantly, many new profiles for mostly young researchers have been created who have currently only arXiv submissions, but not yet published articles. Their enhanced visibility will be one of the most immediate effects of the integration (Figure 5).

## 5 Future challenges

As discussed in Section 3, the additional arXiv entries are partially integrated into the whole zbMATH Open framework, but not all features are currently available. The addition of an automated preliminary classification for the items that have not yet an MSC assigned by the authors is technically feasible and would not be very difficult to incorporate. Also, for some arXiv submissions we already collect software information, although it is not yet displayed. Once fully available, this would further allow for the integration of these entries into the mathematical software information service swMATH. Likewise, the interlinking with the Online Encyclopedia of Integer Sequences (OEIS), the Digital Library of Mathematical Functions (DMFL), and the question-and-answer platform Math-Overflow – as provided for stable zbMATH Open documents – is not yet implemented, and requires further development work. Probably the most challenging task will be the integration into the zbMATH citation database, due to the various formats and unstable version entries of arXiv references.

On the positive side, the availability of open  $\LaTeX$  sources for arXiv documents opens up a considerable future potential. Depending on the licence, a multitude of full-text features could be developed and implemented, ranging from full-text formula search to features involving large language models based on a reliable mathematical corpus. With the information available on the zbMATH Open APIs, we invite the community to develop interesting features which include the newly added information!

## References

- [1] A. Bannister, K. Hulek and O. Teschke, [Das Zitationsverhalten in mathematischen Arbeiten. Einige Anmerkungen](#). *Mitt. Dtsch. Math.-Ver.* **25**, 208–214 (2017)
- [2] A. Bannister and O. Teschke, [An update on time lag in mathematical references, preprint relevance, and subject specifics](#). *Eur. Math. Soc. Newsl.* **106**, 41–43 (2017)
- [3] D. Ehsani and O. Teschke, [On the road to a comprehensive open digital mathematics library](#). *Eur. Math. Soc. Newsl.* **118**, 76–78 (2019)
- [4] M. Fuhrmann and F. Müller, [A REST API for zbMATH Open access](#). *Eur. Math. Soc. Mag.* **130**, 63–65 (2023)
- [5] K. Hulek and O. Teschke, [How do mathematicians publish? – Some trends](#). *Eur. Math. Soc. Mag.* **129**, 36–41 (2023)
- [6] F. Müller and O. Teschke, [Will all mathematics be on the arXiv \(soon\)?](#) *Eur. Math. Soc. Newsl.* **99**, 55–57 (2016)
- [7] F. Müller and O. Teschke, [Progress of self-archiving within the DML corpus, with a view toward community dynamics](#). In *Intelligent Computer Mathematics (CICM 2016)*, Lecture Notes in Comput. Sci. 9791, pp. 63–74, Springer, Cham (2016)
- [8] M. Schubotz and O. Teschke, [Four decades of  \$\TeX\$  at zbMATH](#). *Eur. Math. Soc. Newsl.* **112**, 50–52 (2019)
- [9] M. Schubotz and O. Teschke, [zbMATH Open: Towards standardized machine interfaces to expose bibliographic metadata](#). *Eur. Math. Soc. Mag.* **119**, 50–53 (2021)

---

Isabel Beckenbach studied mathematics at FernUniversität in Hagen, Technical University of Berlin, and Free University of Berlin. From 2013 to 2019 she worked at Zuse Institute Berlin in the Network Optimization department where she completed her PhD in combinatorial optimization and graph theory. In 2020, she moved to FIZ Karlsruhe, and now she works on the transition of zbMATH towards an open information platform for mathematics.

[isabel.beckenbach@fiz-karlsruhe.de](mailto:isabel.beckenbach@fiz-karlsruhe.de)

Klaus Hulek is professor emeritus at Leibniz University Hannover, working in algebraic geometry. He was editor-in-chief of zbMATH Open from 2016 to 2023.

[hulek@math.uni-hannover.de](mailto:hulek@math.uni-hannover.de)

Olaf Teschke is the Head of the Mathematics Department of FIZ Karlsruhe, he is also the managing editor of zbMATH Open and chair of the EMS Committee on Publications and Electronic Dissemination.

[olaf.teschke@fiz-karlsruhe.de](mailto:olaf.teschke@fiz-karlsruhe.de)

# Solved and unsolved problems

Michael Th. Rassias

The present column is devoted to probability theory.

## I Six new problems – solutions solicited

Solutions will appear in a subsequent issue.

284

Let  $V$  be a finite set and  $\tilde{V} \subset V$ . For a finite path  $\mathbf{w} = (w_0, w_1, \dots, w_\eta)$  on  $V$ , we let  $n_0 = 0$ , and for  $i \geq 1$ , we let

$$n_i = \begin{cases} \max\{n_{i-1} \leq n \leq \eta : w_n = w_{n_{i-1}}\} + 1, & \text{if } w_{n_{i-1}} \in \tilde{V} \text{ and } w_{n_{i-1}} \neq w_\eta, \\ n_{i-1} + 1, & \text{if } w_{n_{i-1}} \notin \tilde{V} \text{ and } n_{i-1} \neq \eta. \end{cases}$$

We call  $\mathcal{L}_{\tilde{V}}(\mathbf{w}) := (w_{n_0}, w_{n_1}, \dots, w_{n_i})$ , where  $n_i$  is the last index found by the algorithm, the partial loop erasure (PLE) of  $\mathbf{w}$ .

Let  $(X_n, \mathbb{P}_x)$  be a discrete-time irreducible Markov chain on a finite set  $V$ , and let  $\sigma_A = \min\{n \geq 0 : X_n \in A\}$  and  $X|_{[0, \sigma_A]} = (X_0, X_1, \dots, X_{\sigma_A})$ . Prove that

$$\mathcal{L}_V(X|_{[0, \sigma_A]}) \stackrel{(d)}{=} \mathcal{L}_V \circ \mathcal{L}_{\tilde{V}}(X|_{[0, \sigma_A]}),$$

where  $\stackrel{(d)}{=}$  means that both sides have the same law.

*Shiping Cao (Department of Mathematics, University of Washington, Seattle, USA)*

This problem is a simplified version of Theorem 1 of my recent paper: S. Cao, [Scaling limits of loop-erased Markov chains on resistance spaces via a partial loop-erasing procedure](#). *Adv. Math.* **435**, part B, article no. 109382 (2023).

285

The following democratic process is implemented in a population of  $N$  sheep during a Yes/No referendum. At the initial time  $t = 0$ ,  $m$  sheep are pro-Yes, and  $N - m$  sheep are pro-No. At each time  $t = 1, 2, \dots$ , a sheep is randomly chosen (independently of what happened before) and it bleeps its opinion. Instantly, a sheep from

the opposite camp (if at least one remains) switches its opinion. The process stops when a consensus is reached.

We denote by  $P_{m,N}$  the probability that “Yes” wins when starting with  $m$  pro-Yes sheep in the population. Of course,  $P_{0,N} = 0$ ,  $P_{N,N} = 1$ , and, due to the symmetry of the problem,  $P_{N,2N} = 1/2$ .

*Question.* Find a simple expression for  $P_{m,N}$ . (In particular, this expression should allow you to estimate very easily the evolution of this probability when starting from a very small majority, i.e., estimate  $P_{N+a_N, 2N}$  for different sequences  $1 \ll a_N \ll N$ .)

*Lucas Gerin (CMAP, École Polytechnique, Palaiseau, France)*

286

Let  $\alpha \in \mathbb{R}$  and consider the transition probability density  $P(x; t|y)$  from a point  $y \geq 0$  after a time  $t > 0$  of a Brownian motion on the non-negative real line with reflecting boundary conditions; in particular,  $P(x; t|y)$  is the weak solution of the following initial value problem with Robin boundary condition:

- (1)  $\partial_t P(x; t|y) = \alpha \partial_x P(x; t|y) + \frac{1}{2} \partial_x^2 P(x; t|y)$  for all  $x, y \geq 0$  and  $t > 0$ ;
- (2)  $[2\alpha P(x; t|y) + \partial_x P(x; t|y)]_{x=0} = 0$  for all  $t > 0$ , where the derivative at the origin is the one-sided right derivative;
- (3)  $\lim_{t \rightarrow 0} \int_0^\infty f(x) P(x; t|y) dx = f(y)$  for all bounded continuous functions  $f$  and  $y \geq 0$ .

Prove that the solution is given by

$$P(x; t|y) = \frac{1}{2} \partial_x \left( \operatorname{erfc} \left[ \frac{y-x-at}{\sqrt{2t}} \right] - e^{-2\alpha x} \operatorname{erfc} \left[ \frac{y+x-at}{\sqrt{2t}} \right] \right),$$

for any  $x, y \geq 0$  and  $t > 0$ , where  $\operatorname{erfc}(x) = \frac{2}{\sqrt{\pi}} \int_x^\infty e^{-y^2} dy$  is complementary error function and  $\partial_x$  is the partial derivative with respect to  $x$ .

*Mario Kieburg (School of Mathematics and Statistics, University of Melbourne, Parkville, Melbourne, Australia)*

287

We place  $n$  different pairs of socks in a tumble dryer. When the dryer has thoroughly mixed the socks, they are taken out one by

one. If a sock is the partner of one of the socks on the sorting table, both are removed, otherwise it is put on the table until its partner emerges from the dryer. For  $k \in \{1, \dots, 2n\}$ , let  $X_k$  be the number of socks on the table when the  $k$ th sock is taken from the dryer. With  $X_0 = 0$ , the random path  $(X_0, \dots, X_{2n})$  is a Dyck path. Recall that a path  $(x_0, \dots, x_{2n})$  is called a *Dyck path* if  $|x_i - x_{i+1}| = 1$ ,  $x_i \geq 0$  for  $1 \leq i \leq 2n - 1$  and  $x_0 = x_{2n} = 0$ .

The number of Dyck paths of a given length is given by the Catalan numbers, but not all Dyck paths come up with the same probability in the sock sorting process. For example, for  $n = 2$  there are two Dyck paths,  $(0, 1, 0, 1, 0)$  and  $(0, 1, 2, 1, 0)$ . The former has probability  $\frac{1}{3}$  and the latter  $\frac{2}{3}$ . The problem is now, given a Dyck path  $(x_0, \dots, x_{2n})$  of arbitrary length, to find a formula for the probability

$$\mathbb{P}(X_0 = x_0, X_1 = x_1, \dots, X_{2n} = x_{2n}).$$

*Peter Mörters (University of Cologne, Germany)*

## 288

In a university hospital, there are 9 major medical departments performing surgery. The cardiology unit performs 21% of all surgeries conducted hospital-wide, with 5% of total cardiac surgeries occurring at least twice a day. A total of 30 patients are assigned to surgery. Assuming that surgeries are equally likely on any given day of the year, if two or more surgeries occur on the same day, what is the probability that they are assigned to the cardiology unit?

*Gaetano Valenza (Bioengineering and Robotics Research Center "E. Piaggio" & Department of Information Engineering, School of Engineering, University of Pisa, Italy)*

## 289

It is the king's birthday, and he decides to please the republican sentiments in the population and release some prisoners who are held for their republican views. The prisoners all have equally excellent rational skills and are placed in separate castles, so that they are unable to speak and communicate with each other. The king decides to challenge the prisoners and gives each of them a coin. Within a quarter of an hour, each of them, say  $n$  prisoners, has to decide whether to toss the coin or not. If at least one coin is tossed and all coins being tossed show head, all  $n$  prisoners are released, otherwise none of them are. The king believes the prisoners have a slim chance of being released. But is that so? What is the probability that they all are released? The prisoners are told the number  $n$ .

*Carsten Wiuf (Department of Mathematical Sciences, University of Copenhagen, Denmark)*

## II Open problems

*by Van Vu (Department of Mathematics, Yale University, USA)*

### Open problems on random matrices

Let  $M_n$  be a random matrix of size  $n$  whose entries are iid  $\pm 1$  random variables (with probability  $1/2$  each). It is known that most of the eigenvalues of this matrix, with high probability, are complex and distribute by the circular law [2]. The question here is that how many are real.

The following conjecture is motivated by my joint work with T. Tao in [3].

### 290\*. Conjecture (real eigenvalues)

$M_n$  has, with probability  $1 - o(1)$ ,  $\Theta(\sqrt{n})$  real eigenvalues.

Edelman, Kostlan, and Shub [1] obtained a precise formula for the expectation of the number of real eigenvalues for a Gaussian matrix, which is of order  $\sqrt{n}$ . In [3], Tao and Vu proved that the same formula holds (in the asymptotic sense) for certain random matrices with entries  $0, \pm 1$ , as a part of a Four Moment Theorem for non-symmetric matrices. However, we cannot extend the proof to  $M_n$ . As a matter of fact, it is not known that with high probability,  $M_n$  has at least 2 real roots.

The next problem bears some resemblance to the famous "rigidity" problem in computer science. Given a  $\pm 1$  matrix  $M$ , let  $\text{Res}(M)$  denote the minimum number of entries we need to switch (from 1 to  $-1$  and vice versa) in order to make  $M$  singular. Thus,  $\text{Res}(M)$  can be seen as the resilience of  $M$  against an effort to reduce its rank. It is easy to show that  $\text{Res}(M_n)$  is, with high probability, at most  $(1/2 + o(1))n$ , it typically takes this many switches to make the first two rows of the matrix equal.

### 291\*. Conjecture (rank resilience)

With probability  $1 - o(1)$ ,  $\text{Res}(M_n) = (1/2 + o(1))n$ .

For more discussion and related problems, we refer to [4].

### References

- [1] A. Edelman, E. Kostlan and M. Shub, [How many eigenvalues of a random matrix are real?](#) *J. Amer. Math. Soc.* **7**, 247–267 (1994)
- [2] T. Tao and V. Vu, [From the Littlewood–Offord problem to the circular law: universality of the spectral distribution of random matrices.](#) *Bull. Amer. Math. Soc. (N.S.)* **46**, 377–396 (2009)
- [3] T. Tao and V. Vu, [Random matrices: Universality of local spectral statistics of non-Hermitian matrices.](#) *Ann. Probab.* **43**, 782–874 (2015)

### III Solutions

276

Consider the tiling of the plane by regular hexagon tiles, with centers in the lattice  $L$  of all  $\mathbb{Z}$ -linear combinations of the vectors  $(1, 0)$  and  $(-\frac{1}{2}, \frac{\sqrt{3}}{2})$ . Glue all but finitely many tiles into position, remove the unglued tiles to form a region, discard some of these tiles, and arrange the remaining  $n$  unglued tiles in the region without rotating them, in arbitrary positions such that none of the tiles overlap. Is there a way to slide the unglued tiles within the region, keeping them upright and non-overlapping, so that their centers all end up in  $L$ ?

*Hannah Alpert (Department of Mathematics and Statistics, Auburn University, USA)*

#### *Solution by the proposer*

Yes. We think of tiles as being specified by their centers, so we use the word “tile” to mean “center of a tile” whenever the meaning is unambiguous. Our first lemma shows that it suffices to slide the tiles to  $L^*$ , which we define to be the lattice that contains  $L$  as well as all the vertices of the hexagons of the original tiling. This lattice  $L^*$  is generated by the vectors  $(0, \frac{\sqrt{3}}{3})$  and  $(\frac{1}{2}, \frac{\sqrt{3}}{6})$ , which are orthogonal to  $(1, 0)$  and  $(-\frac{1}{2}, \frac{\sqrt{3}}{2})$ , respectively.

**Lemma 1.** *Starting with any arrangement where all tiles are in  $L^*$ , we can slide so that they all end up in  $L$ .*

*Proof.* We use induction on the number of tiles not in  $L$ . Among the tiles not in  $L$ , find those with the least  $y$ -coordinate, and among these, select the one with the least  $x$ -coordinate. Either this tile can slide down along  $(0, -\frac{\sqrt{3}}{3})$  to a point in  $L$ , or it can slide down-left along  $(-\frac{1}{2}, -\frac{\sqrt{3}}{6})$  to a point in  $L$ .

We want to slide from an arbitrary tile arrangement to  $L^*$ . In the starting arrangement, sliding is obstructed by *tangencies*, which are pairs of tiles that touch. When two tiles touch only at vertices, we call it a *double tangency*. We can make a *graph of all tangencies* by drawing an edge between the centers of each pair of tiles that are tangent, whether they are both unglued tiles, or one unglued and one glued, or both glued; this graph is embedded in the plane. Any subset of the tangencies determines a linear subspace of  $\mathbb{R}^{2n}$ , consisting of the infinitesimal perturbations of the unglued tiles that preserve those tangencies. If a pair of tiles is tangent but the tangency is not included in the subset, the perturbation is allowed to destroy the tangency, either by making the tiles overlap, or by creating a gap between them. We say that

a tangency graph is *rigid* if this linear subspace of perturbations is trivial.

Our strategy for sliding all tiles to  $L^*$  is to find a perturbation direction that preserves all the tangencies, and slide in that direction until a new tangency forms. Then we find a perturbation direction that preserves all the tangencies, including the new one, slide in that direction, and so on, until the graph of all tangencies becomes rigid. The next lemma completes the proof.

**Lemma 2.** *If the graph of all tangencies of an arrangement of tiles is rigid, then all tiles are in  $L^*$ .*

*Proof.* First we describe in more detail how a tangency graph determines a linear subspace of perturbations. For some tangencies, the vector along that edge of the graph is fixed: this includes any tangency between two glued tiles, and any double tangency. Otherwise, the edge vector is determined by a variable *offset*. There are three *types* of tangencies with variable offsets, corresponding to the three directions of tile sides along which the tangency may occur. The linear subspace of perturbations is specified by a system of linear equations, with one variable for each variable offset, and two equations for each face of the tangency graph, which mandate that the sum of vectors along the edges of that face is zero as a vector in  $\mathbb{R}^2$ .

To prove the lemma, we consider subgraphs of the graph of all tangencies; these subgraphs contain all the tiles and all the edges with fixed edge vectors, but not necessarily all the edges with variable offset. We show by induction on the number of edges with variable offset that if a tangency subgraph is rigid, then all of its edge vectors are in  $L^*$ . This implies that the tiles are also in  $L^*$ , because in a rigid tangency subgraph, every unglued tile has a path connecting it to a glued tile.

Consider the case where a face has only one edge with variable offset. Then that edge vector is determined by the others along that face, so if we remove that edge, the resulting tangency subgraph is still rigid, and we may apply the inductive hypothesis.

Next, consider the case where a face has (at least) two edges with variable offsets, of different types. The sum of these two edge vectors uniquely determines their two offsets, so the two edge vectors are determined by the others along that face. Thus, removing both edges gives a rigid tangency graph, to which we can apply the inductive hypothesis. The fact that the sum of the two edge vectors is in  $L^*$  implies that each of the two is in  $L^*$ .

To address any remaining cases, we draw the dual graph to the tangency subgraph, with one vertex for each face of the tangency subgraph, and one edge for each edge with variable offset in the tangency subgraph, connecting the faces on the two sides of that edge. If the dual graph has no loops or cycles, then either it has no edges, so we are in the base case, or it has a vertex with only one edge, so we are in the first case already addressed. If the dual graph has a cycle with edges of more than one type, then we are

in the second case already addressed. The remaining case is where the dual graph has a loop or cycle with edges of only one type, but this contradicts rigidity, because we could shift all tiles enclosed by the cycle. Thus, there are no remaining cases.

277

Find two non-homeomorphic topological spaces  $A$  and  $B$  such that their products with the interval,  $A \times [0, 1]$  and  $B \times [0, 1]$ , are homeomorphic.

*Guillem Cazassus (Mathematical Institute,  
University of Oxford, UK)*

*Solution by the proposer*

One can take  $A$  the 2-sphere with 3 discs removed, and  $B$  the 2-torus with one disc removed. These can both be seen as obtained from the 2-disc by attaching two 1-handles, as in Figure 1. After taking their products with  $[0, 1]$ , the extra dimension added allows to exchange the attaching positions of the handles to go from the first picture to the second.

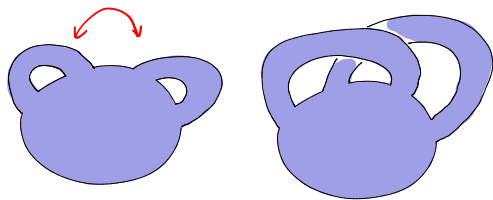

Figure 1. Exchanging the attaching positions of the handles.

278

What is the topology of the space of straight lines in the plane?

*Guillem Cazassus (Mathematical Institute,  
University of Oxford, UK)*

*Solution by the proposer*

Call this space  $\mathcal{M}$ . It is an open Möbius strip: here are two possible ways to see this.

*Solution 1:* Let  $\mathcal{M}_0 \subset \mathcal{M}$  correspond to the lines passing through the origin. Then  $\mathcal{M}_0$  is a circle  $\mathbb{R}/\pi\mathbb{Z}$ , and one can consider the projection  $\mathcal{M} \rightarrow \mathcal{M}_0$  sending a line to its parallel passing through 0. This is a fibration, with fiber  $\mathbb{R}$ , and the inclusion  $\mathcal{M}_0 \hookrightarrow \mathcal{M}$  gives a section of it. There are two such fibrations possible: the trivial one (cylinder) and the Möbius strip. The one we consider cannot be trivial, otherwise it would mean that one can find another section disjoint from  $\mathcal{M}_0$ . This would mean that one can take a given line disjoint from the origin, and half-twist it con-

tinuously without hitting the origin. Therefore, it is the Möbius strip.

*Solution 2:* We can view  $\mathcal{M}$  as the quotient of  $\mathcal{M}^{\text{or}}$ , the space of oriented lines. First,  $\mathcal{M}^{\text{or}}$  can be identified with the cylinder  $(\mathbb{R}/2\pi\mathbb{Z}) \times \mathbb{R}$ , the first coordinate being the angle with the horizontal axis, and the second the “algebraic distance” to the origin (take the distance, and put a minus sign if the origin is at the left of the line).

Second, under this identification, the involution reversing the orientation of a line is the map  $\iota: (\theta, d) \mapsto (\theta + \pi, -d)$ , and  $\mathcal{M} \simeq \mathcal{M}^{\text{or}}/\iota$ . It follows that  $\mathcal{M}$  can be obtained from the strip  $[0, \pi] \times \mathbb{R}$  (a fundamental domain for  $\iota$ ) by identifying its two edges by the twist  $(0, d) \sim (\pi, -d)$ , which gives a Möbius strip.

279

In the standard twin paradox, Greg stays at home whilst John travels across space. John finds, upon returning, that he has aged less than Greg. This is an apparent paradox because of the symmetry in the situation: in John’s rest frame, it seems like Greg is doing the moving and so should also be experiencing time dilation. The standard explanation of the paradox is that there is no symmetry: at some point John needs to turn around (accelerate), so, unlike Greg, John’s rest frame is not inertial for all times. So let’s modify the set-up: suppose that space-time is a cylinder (space is a circle). Now, John eventually comes back to where he started without needing to decelerate or accelerate. In this fleeting moment of return, as the twins pass one another, who has aged more?

*Jonny Evans (Department of Mathematics and Statistics,  
University of Lancaster, UK)*

*Solution by the proposer*

John has aged more. You can just integrate to compute his proper time and see it is smaller. If the speed of John is  $v$ , the size of the universe is  $L$  and the speed of light is  $c$ , then the proper time until return measured by John is

$$\int_0^{L/v} \sqrt{dt^2 - dx^2/c^2} = L\sqrt{1/v^2 - 1/c^2}$$

against Greg’s  $L/v$ .

But why is this not a paradox? Again, the problem is that, despite appearances, there is no symmetry in the situation. In other words, there is no global isometry of space-times interchanging their rest frames. Space-time is foliated by a distinguished family of closed space-like geodesic loops. These are orthogonal to Greg’s world-line, but not to John’s. This means that, unlike in Minkowski space-time, John could do an experiment to figure out that he is moving. For example, suppose that Greg sees John moving to the right. If John emits a red light ray leftwards and a blue light ray



rightwards, and waits for them to circle around the universe, he will see the red light ray return first; see Figure 2.

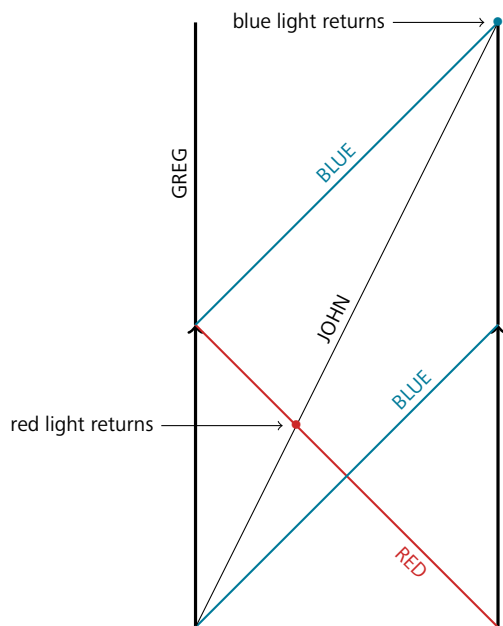

Figure 2. John's experiment in Greg's rest frame.

You can read a more leisurely discussion of this version of the twin paradox in the following paper: J. R. Weeks, [The twin paradox in a closed universe](#). *Amer. Math. Monthly* **108**, 585–590 (2001).

## 280

The  $k$ -dilation of a piecewise smooth map is the degree to which it stretches  $k$ -dimensional area. Formally, for a map  $f: U \rightarrow V$  between subsets  $U \subseteq \mathbb{R}^m$  and  $V \subseteq \mathbb{R}^n$ , or more generally between Riemannian manifolds,

$$\text{Dil}_k(f) = \sup\{|\wedge^k Df_x| \mid x \in U\},$$

where  $\wedge^k Df_x: \wedge^k T_x U \rightarrow \wedge^k T_{f(x)} V$  is the induced map on the  $k$ -th exterior power and  $|\cdot|$  is the operator norm. A map of rank  $k - 1$  has  $k$ -dilation zero, so this can be thought of as a quantitative refinement of rank.

Consider the rectangular prism  $R_\varepsilon = [0, 1]^2 \times [0, \varepsilon]$ .

- (1) Let  $f: R_1 \rightarrow R_\varepsilon$  be a map of relative degree 1, that is, it restricts to a degree-1 map between the boundaries of the rectangles. Show that the 2-dilation of such a map is bounded below by a  $C > 0$  which does not depend on  $\varepsilon$ .
- (2) Now let  $c_\varepsilon$  be the minimum 2-dilation of a surjective map  $f: R_1 \rightarrow R_\varepsilon$ . Construct examples to show that  $c_\varepsilon \rightarrow 0$  as  $\varepsilon \rightarrow 0$ .

Fedor (Fedya) Manin (Department of Mathematics, University of California, Santa Barbara, USA)

## Solution by the proposer

- (1) The statement follows from applying the idea that “2-dilation is the degree to which the map stretches area of surfaces” to the boundary. Let  $f: R_1 \rightarrow R_\varepsilon$  be a map of relative degree 1, and write  $dA$  for the area form on  $\partial R_\varepsilon$ . By the definition of degree,

$$\text{Area}(\partial R_\varepsilon) = \int_{\partial R_1} f^* dA.$$

Now,  $f^* dA(v_1 \wedge v_2) = dA(Df(v_1) \wedge Df(v_2)) \leq \text{Dil}_2(f) |v_1 \wedge v_2|$ , and therefore

$$\text{Area}(\partial R_\varepsilon) \leq \text{Dil}_2(f) \text{Area}(\partial R_1).$$

Therefore,  $\text{Dil}_2(f) \geq 1/3$ .

- (2) Assume that  $\varepsilon = n^{-3}$  for some integer  $n$ . We will construct a map  $f: R_1 \rightarrow R_\varepsilon$  with  $\text{Dil}_2(f) = 16n^{-2} = 16\varepsilon^{2/3}$ . The basic idea is to use the fact that  $R_1$  has much larger volume than  $R_\varepsilon$ . Some portion of that volume will be cut up into chunks, shrunk down by a factor of around  $n$ , and distributed surjectively over  $R_\varepsilon$ . The rest will be used to make the map continuous; this may be highly distorted, but does not contribute to the 2-dilation because it maps to a one-dimensional subspace of  $R_\varepsilon$ .

Split  $R_\varepsilon$  into an  $n^3 \times n^3$  grid of cubes  $K_1, \dots, K_{n^6}$  of side length  $n^{-3}$ . These are in one-to-one correspondence with an  $n^2 \times n^2 \times n^2$  grid of cubes  $L_1, \dots, L_{n^6}$  in  $R_1$  of side length  $n^{-2}$ . Let  $L'_i$  be the cube of side length  $\frac{2}{3}n^{-2}$  which is concentric with  $L_i$ . We define  $f$  on each  $L'_i$  so that it maps  $\partial L'_i$  to the center of  $K_i$  and the interior of  $L'_i$  surjectively over  $K_i$ , with  $Df|_{\partial L'_i} = 0$ . Such a map can be made  $4n^{-1}$ -Lipschitz, and therefore its 2-dilation is  $16n^{-2}$ . Outside the  $L'_i$ , we can extend this map to a smooth map whose image is a tree embedded in  $R_\varepsilon$ , the vertices of which are the centers of the  $K_i$ . Since the tree is one-dimensional, the 2-dilation of this portion is zero.

This problem demonstrates a tension frequently encountered in metric geometry. Suppose you are trying to construct a map between two spaces with certain properties and geometric bounds. When you try to do it the obvious way, the geometric complexity blows up in one direction but stays very small in another. Can the map be modified by “trading off” these dimensions while preserving the desired properties?

Both halves of the problem are inspired by research papers: (2) is an approximate version of a construction by Kaufman of a rank 1 map from the cube to the square [3], while (1) is a simple case of a complex and surprising result of Guth [2, Theorem 2]. For other pairs of rectangles Guth shows, using a very different construction, that one can trade off between different dimensions to some degree even while constructing maps of relative degree 1. Both Kaufman's and Guth's constructions have inspired further work.

For instance, Wenger and Young [4] used a construction similar to Kaufman's to show that certain Lipschitz maps from spheres to Heisenberg groups (unexpectedly!) have Lipschitz extensions to balls. In contrast, Goldstein, Hajłasz and Pankka [1] used a Kaufman-style construction to create low-rank maps  $S^{n+1} \rightarrow S^n$  which are actually topologically nontrivial.

#### References

- [1] P. Goldstein, P. Hajłasz and P. Pankka, [Topologically nontrivial counterexamples to Sard's theorem](#). *Int. Math. Res. Not. IMRN*, no. 20, 7073–7096 (2020)
- [2] L. Guth, [The width-volume inequality](#). *Geom. Funct. Anal.* **17**, 1139–1179 (2007)
- [3] R. Kaufman, [A singular map of a cube onto a square](#). *J. Differential Geometry* **14**, 593–594 (1979)
- [4] S. Wenger and R. Young, [Lipschitz homotopy groups of the Heisenberg groups](#). *Geom. Funct. Anal.* **24**, 387–402 (2014)

#### 281

Given a triangle in the (real or complex) plane, show that there is a natural bijection between the set of smooth conics passing through the vertices and the set of lines avoiding the vertices.

*Jack Smith (St John's College, University of Cambridge, UK)*

#### *Proof by the proposer*

Suppose  $C$  is a conic through the vertices  $P$ ,  $Q$ , and  $R$  of the triangle, and let  $\ell_P$ ,  $\ell_Q$ , and  $\ell_R$  be its respective tangent lines at these points. By Pascal's theorem, the intersections  $\ell_P \cap QR$ ,  $\ell_Q \cap RP$ , and  $\ell_R \cap PQ$  are collinear, lying on a line  $L$  say. We claim that the map  $C \mapsto L$  (is well defined and) gives the desired bijection.

To prove this, take homogeneous coordinates  $[x : y : z]$  on the plane in which  $P$ ,  $Q$ , and  $R$  are  $[1 : 0 : 0]$ ,  $[0 : 1 : 0]$ , and  $[0 : 0 : 1]$ , respectively. A general conic through these points is described by the equation

$$ayz + bzx + cxy = 0$$

for a unique  $[a : b : c]$  in  $\mathbb{P}^2$ . The conic is smooth if and only if  $a$ ,  $b$ , and  $c$  are all non-zero. Meanwhile, a general line in the plane is described by the equation

$$ax + \beta y + \gamma z = 0,$$

and it avoids  $P$ ,  $Q$ , and  $R$  if and only if  $\alpha$ ,  $\beta$ , and  $\gamma$  are all non-zero. It therefore remains to show that the map  $C \mapsto L$  induces a bijection from triples of non-zero scalars  $(a, b, c)$  to triples of non-zero scalars  $(\alpha, \beta, \gamma)$ .

Suppose then that  $C$  is the smooth conic

$$ayz + bzx + cxy = 0.$$

Differentiating, we see that the line  $\ell_P$  is  $cy + bx = 0$ , so

$$\ell_P \cap QR = [0 : b : -c].$$

Similarly  $\ell_Q \cap RP = [-a : 0 : c]$  and  $\ell_R \cap PQ = [a : -b : 0]$ , and we see that there is a unique line  $L$  through these points, with the equation

$$bcx + cay + abz = 0.$$

So the map  $C \mapsto L$  is well defined and corresponds to

$$(a, b, c) = (bc, ca, ab).$$

This is a bijection, with inverse

$$(a, b, c) = (\beta\gamma, \gamma\alpha, \alpha\beta),$$

so we are done.

*We wait to receive your solutions to the proposed problems and ideas on the open problems. Send your solutions to Michael Th. Rassias by email to [mthrassias@yahoo.com](mailto:mthrassias@yahoo.com).*

*We also solicit your new problems with their solutions for the next "Solved and unsolved problems" column, which will be devoted to discrete mathematics.*

# Book reviews

**Applications of Homogenization Theory to the Study of Mineralized Tissue** by Robert P. Gilbert, Ana Vasilic, Sandra Klinge, Alex Panchenko and Klaus Hackl

Reviewed by Michael Shoushani

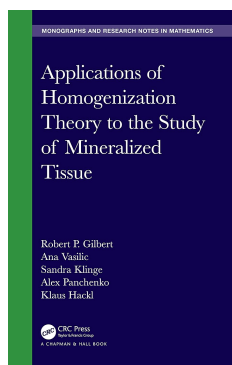

Homogenization is a powerful tool used in the analysis of applied problems which have multiple scales and complex structures. Broadly speaking, homogenization provides a basis to determine macroscopic (effective) equations for materials by using the properties of the material at the microscale. Oftentimes the structures to which homogenization is applied have or are assumed to have a periodic structure and the notion of two-scale convergence can play an important role in the analysis, but homogenization is not restricted to only this case and can be applied to more general disordered (non-periodic) media. Here a more general framework of convergence such as  $G$ -convergence may be used in the analysis. This research monograph serves as an introduction to homogenization theory, while at the same time it explains how to use homogenization in applications in biology, physics, and engineering that will appeal to a wide audience.

The book starts with an introductory chapter where important theory and notions needed for subsequent chapters are introduced. This includes some fundamental functional analysis, important function spaces, and essential theorems regarding concepts such as strong and weak derivatives, the trace theorem, the Lax–Milgram theorem, and so on. This chapter also includes the geometric description of the porous medium that the authors propose to study. Starting with the unit cell  $\mathcal{Y} = ]0, 1[^n$  where  $n = 2, 3$ , letting  $\mathcal{Y}^s$  (the solid part) be a subset of  $\mathcal{Y}$  and  $\mathcal{Y}^f = \mathcal{Y} \setminus \mathcal{Y}^s$  (the fluid part), making the periodic arrangement of  $\mathcal{Y}^s$  over  $\mathbb{R}^n$ , the authors outline the process for obtaining the domains  $\Omega_\varepsilon^s$  and  $\Omega_\varepsilon^f$ , which represent the solid and fluid parts of the porous medium  $\Omega = ]0, L[^n$ .

After discussing the geometry, several important homogenization notions are introduced, including the following:

- Two-scale convergence, namely:

*The sequence  $\{w^\varepsilon\} \subset L^2(\Omega)$  is said to two-scale converge to a limit  $w \in L^2(\Omega \times \mathcal{Y})$  if for any  $\sigma \in C^\infty(\Omega; C_\#^\infty(\mathcal{Y}))$  one has*

$$\lim_{\varepsilon \rightarrow 0} \int_{\Omega} w^\varepsilon(x) \sigma\left(x, \frac{x}{\varepsilon}\right) dx = \int_{\Omega} \int_{\mathcal{Y}} w(x, y) \sigma(x, y) dy dx.$$

Here  $\#$  denotes unit cube periodicity.

- A homogenized equation for a boundary value problem with unknown  $u(x)$  and an asymptotic solution in powers of  $\varepsilon \rightarrow 0$ , namely:

$$u(x) = u^0(x) + \varepsilon^1 u^1(x, y) + \varepsilon^2 u^2(x, y) + \dots, \quad \text{where } y = \frac{x}{\varepsilon}.$$

The introductory chapter ends with a discussion of two-scale convergence with time dependence, and potential and solenoidal fields.

With the stage set for subsequent chapters, the authors then move on to discuss a range of applications of homogenization theory. These cover the technique applied to soft tissue (the authors note that soft tissue does not have a periodic structure, but there is a scale separation), and include applications of homogenization pertaining to the following topics:

- acoustics in porous media,
- wet ionic piezoelectric bone,
- viscoelasticity with contact friction between the phases,
- acoustics in random microstructure (in this chapter the notion of stochastic two-scale limits as well as compactness properties of the convergence are discussed),
- bone tissue modeled as a periodic two-phase material composed of a viscoelastic solid matrix filled with a non-Newtonian fluid (representing bone marrow),
- homogenization of viscoelastic flows (the notion of  $G$ -convergence is introduced when this application is discussed),
- multiscale FEM for the modeling of cancellous bone.

In summary, this textbook provides a well-planned introduction to the theory and applications of homogenization. The applications discussed provide a strong motivation for further study of the topic. As stated by the authors, the book is a result of years of

research collaborations. As such, it would serve as a great reference for researchers including those such as applied mathematicians, engineers, and geophysicists. It could also serve as a textbook for a course or courses in homogenization theory or a special graduate seminar course. A motivated student could also use the book for self-study. The bibliography contains over 400 references and provides a good basis for further reading.

Robert P. Gilbert, Ana Vasilic, Sandra Klinge, Alex Panchenko and Klaus Hackl, *Applications of Homogenization Theory to the Study of Mineralized Tissue*. Chapman & Hall, 2020, 297 pages, Hardback ISBN 978-1-584-88791-1, Paperback ISBN 978-0-367-71372-0, eBook ISBN 978-0-4291-4338-0.

---

Michael Shoushani is an associate professor of mathematics at Western Connecticut State University. His interests include inverse and transmission problems in poroelastic media.

[shoushanim@wcsu.edu](mailto:shoushanim@wcsu.edu)

DOI 10.4171/MAG/177

### *Fantastic Numbers and Where to Find Them: A Journey to the Edge of Physics* by Antonio Padilla

Reviewed by Dominic Thorrington

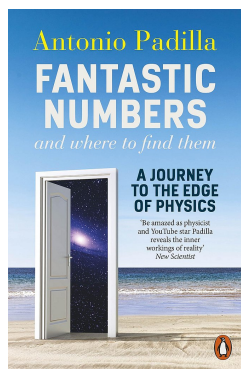

This is not the book that I expected it to be. Perhaps it was naïve of me, but I bought this book based on the title (the different subtitles *A Cosmic Quest from Zero to Infinity* and *A Journey to the Edge of Physics* were added to different versions of the book at later dates) and I thought this was a book written in a similar fashion to some of Marcus du Sautoy's books on prime numbers. I was surprised that this is much more of a theoretical physics

book that uses interesting numbers as the inroad to discussing important concepts in quantum mechanics and cosmology. However, I was not at all disappointed – theoretical physics and cosmology is an interest of mine that I have neglected for a while, so this reintroduction to the subject was welcomed. It is worth keeping the subject in mind, though, if you are looking for a new maths book for yourself or for a fellow mathematician – this book is quite specialised, and some prior knowledge of theoretical physics would be very helpful.

Padilla is certainly known to some readers as one of the experts interviewed regularly on Brady Haran's *Numberphile* YouTube channel. Padilla is a theoretical physicist and cosmologist at the University of Nottingham who regularly appears on the channel to discuss topics as wide-ranging as the sum of the infinite series of natural numbers, the gaps between prime numbers, how many particles are in the universe, and the multiverse. His book is just as fun and as interesting as his videos.

Padilla begins the book with a brief introduction and a story from his mathematical studies at Cambridge University. He received a score of zero from his tutor for a proof because it was not rigorous enough, encouraging Padilla to be more meticulous with his work and studies. It is an interesting story, but the book takes quite a turn after that when the main chapters start, leaving the introduction to appear rather disconnected.

The chapters of the book are structured into three main sections: big numbers, little numbers, and infinity. The first section discusses a googol, a googolplex, Graham's number and TREE(3), but it also discusses the number 1.000000000000000858. This number allows Padilla to discuss electromagnetism, the special theory of relativity, and time dilation, with the discussion flowing effortlessly, and all of that is presented to the reader using the analogy of Usain Bolt's record-breaking 100 m sprint in Berlin.

Padilla's skill is in starting his discussions using something well understood by the reader, then moving laterally into something new, all very smoothly and in a way that leads the reader into the complexities of quantum mechanics quite easily. How long the reader stays in the more complex areas of the book depends on their prior knowledge of the subject, as I feel that a complete novice would struggle to follow the discussions once they have moved far away from the initial subject. This probably is not a *Quantum Mechanics for Absolute Beginners* book..., but then again, could such a book be written?

Subsequent chapters present the importance of the discovery of the number zero and the discovery of the Higgs boson. The book ends with a fascinating chapter on infinity, managing to present the concept of cardinality of infinite sets in one of the most accessible ways that I have seen.

There are some errors in the book that some readers will notice, and having read other reviews of the book online I am not sure if they have been corrected in subsequent versions of the book. In a chapter that delves into the Standard Model of particle physics, Padilla presents the quarks and the leptons, but mislabels all the leptons as quarks (up, down, charm, etc.), which is a surprising proofreading error. I also think there is another error in the discussion of the cardinality of infinite sets, writing  $\aleph_0 = \aleph_0$  when he meant to write  $\aleph_0 + \aleph_0$ , which was crucial to the point of that chapter.

But those minor issues aside, this is an excellent book to read as long as you do not make the same mistake that I did. If you do

not have a major interest in quantum mechanics or cosmology, but you have some prior pre-university studies on the topic, this is an excellent read.

Antonio Padilla, *Fantastic Numbers and Where to Find Them: A Journey to the Edge of Physics*. Penguin, 2022, 352 pages, Paperback ISBN 978-0-141-99282-2, eBook ISBN 978-0-241-44538-9.

Dominic Thorrington is a scientific project manager at the Haute Autorité de Santé, the French healthcare regulator. He focuses on the evaluation of new vaccination strategies against infectious disease, with a focus on the modelling of epidemics and economic evaluations. He is on the editorial boards of several epidemiological and healthcare journals.

[dthorrington@ymail.com](mailto:dthorrington@ymail.com)

DOI 10.4171/MAG/186

## EMS Press title

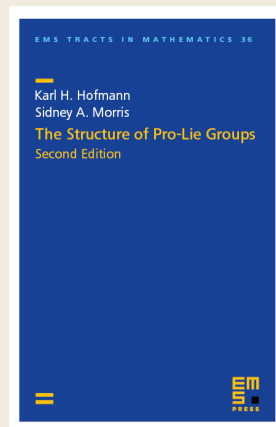

### The Structure of Pro-Lie Groups Second Edition

Karl H. Hofmann  
(Technische Universität  
Darmstadt; Tulane University)

Sidney A. Morris  
(La Trobe University; Federation  
University Australia)

ISBN 978-3-98547-048-8  
eISBN 978-3-98547-548-3

2023. Hardcover. 840 pages  
€ 119.00\*

Lie groups were introduced in 1870 by the Norwegian mathematician Sophus Lie. A century later Jean Dieudonné quipped that Lie groups had moved to the center of mathematics and that one cannot undertake anything without them.

For half a century, locally compact pro-Lie groups have drifted through the literature, yet this is the first book which systematically treats the Lie theory and the structure theory of pro-Lie groups irrespective of local compactness.

The book is a continuation of the authors' monograph on the structure of compact groups and is an invaluable tool for researchers in topological groups, Lie theory, harmonic analysis and representation theory. It is written to be accessible to advanced graduate students wishing to study this fascinating and important area of research, which has so many fruitful interactions with other fields of mathematics

*\*20% discount on any book purchases for individual members of the EMS, member societies or societies with a reciprocity agreement when ordering directly from EMS Press.*

EMS Press is an imprint of the European Mathematical Society – EMS – Publishing House GmbH  
Straße des 17. Juni 136 | 10623 Berlin | Germany  
<https://ems.press> | [orders@ems.press](mailto:orders@ems.press)



ADVERTISEMENT

## European Mathematical Society

### EMS executive committee

#### President

Jan Philip Solovej (2023–2026)  
University of Copenhagen, Denmark  
[solovej@math.ku.dk](mailto:solovej@math.ku.dk)

#### Vice presidents

Beatrice Pelloni (2017–2024)  
Heriot-Watt University, Edinburgh, UK  
[b.pelloni@hw.ac.uk](mailto:b.pelloni@hw.ac.uk)

Jorge Buescu (2021–2024)  
University of Lisbon, Portugal  
[jbuescu@gmail.com](mailto:jbuescu@gmail.com)

#### Treasurer

Samuli Siltanen (2023–2026)  
University of Helsinki, Finland  
[samuli.siltanen@helsinki.fi](mailto:samuli.siltanen@helsinki.fi)

#### Secretary

Jiří Rákosník (2021–2024)  
Czech Academy of Sciences, Praha, Czech Republic  
[rakosnik@math.cas.cz](mailto:rakosnik@math.cas.cz)

#### Members

Victoria Gould (2023–2026)  
University of York, UK  
[victoria.gould@york.ac.uk](mailto:victoria.gould@york.ac.uk)

Frédéric Hélein (2021–2024)  
Université de Paris, France  
[helein@math.univ-paris-diderot.fr](mailto:helein@math.univ-paris-diderot.fr)

Barbara Kaltenbacher (2021–2024)  
Universität Klagenfurt, Austria  
[barbara.kaltenbacher@aau.at](mailto:barbara.kaltenbacher@aau.at)

Luis Narváez Macarro (2021–2024)  
Universidad de Sevilla, Spain  
[narvaez@us.es](mailto:narvaez@us.es)

Susanna Terracini (2021–2024)  
Università di Torino, Italy  
[susanna.terracini@unito.it](mailto:susanna.terracini@unito.it)

#### EMS publicity officer

Richard H. Elwes  
University of Leeds, UK  
[r.h.elwes@leeds.ac.uk](mailto:r.h.elwes@leeds.ac.uk)

#### EMS secretariat

Elvira Hyvönen  
Department of Mathematics and Statistics  
P.O. Box 68  
00014 University of Helsinki, Finland  
[ems-office@helsinki.fi](mailto:ems-office@helsinki.fi)

### Join the EMS

You can join the EMS or renew your membership online at [euromathsoc.org/individual-members](https://euromathsoc.org/individual-members).

#### Individual membership benefits

- Printed version of the EMS Magazine, published four times a year for no extra charge
- Free access to the online version of the *Journal of the European Mathematical Society* published by EMS Press
- Reduced registration fees for the European Congresses
- Reduced registration fee for some EMS co-sponsored meetings
- 20 % discount on books published by EMS Press (via [orders@ems.press](mailto:orders@ems.press))\*
- Discount on subscriptions to journals published by EMS Press (via [subscriptions@ems.press](mailto:subscriptions@ems.press))\*
- Reciprocity memberships available at the American, Australian, Canadian and Japanese Mathematical Societies

\* These discounts extend to members of national societies that are members of the EMS or with whom the EMS has a reciprocity agreement.

#### Membership options

- 25 € for persons belonging to a corporate EMS member society (full members and associate members)
- 37 € for persons belonging to a society, which has a reciprocity agreement with the EMS (American, Australian, Canadian and Japanese Mathematical societies)
- 50 € for persons not belonging to any EMS corporate member
- A particular reduced fee of 5 € can be applied for by mathematicians who reside in a developing country (the list is specified by the EMS CDC).
- Anyone who is a student at the time of becoming an individual EMS member, whether PhD or in a more junior category, shall enjoy a three-year introductory period with membership fees waived.
- Lifetime membership for the members over 60 years old.
- Option to join the EMS as reviewer of zbMATH Open.

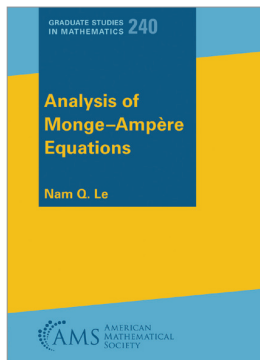

## ANALYSIS OF MONGE–AMPERE EQUATIONS

Nam Q. Le, *Indiana University*

*Graduate Studies in Mathematics, Vol. 240*

Presents a systematic analysis of the Monge–Ampère equation, the linearized Monge–Ampère equation, and their applications, with emphasis on both interior and boundary theories. Starting from scratch, this book gives an extensive survey of fundamental results, essential techniques, and intriguing phenomena in the solvability, geometry, and regularity of Monge–Ampère equations.

Apr 2024 589pp

9781470476250 Paperback €89.00

9781470474201 Hardback €135.00

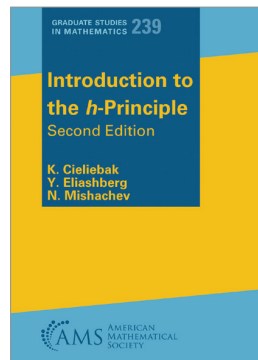

## INTRODUCTION TO THE *h*-PRINCIPLE

Second Edition

K. Cieliebak, *University of Augsburg*,  
Y. Eliashberg, *Stanford University* &  
N. Mishachev, *Lipetsk Technical University*

*Graduate Studies in Mathematics, Vol. 239*

The authors cover two main methods for proving the *h*-principle: holonomic approximation and convex integration. The reader will find that, with a few notable exceptions, most instances of the *h*-principle can be treated by the methods considered here. A special emphasis is made on applications to symplectic and contact geometry.

Apr 2024 363pp

9781470476175 Paperback €89.00

9781470461058 Hardback €135.00

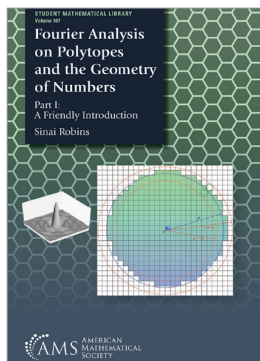

## FOURIER ANALYSIS ON POLYTOPES AND THE GEOMETRY OF NUMBERS

Part I: A Friendly Introduction

Sinai Robins, *University of São Paulo*

*Student Mathematical Library, Vol. 107*

Offers a gentle introduction to the geometry of numbers from a modern Fourier-analytic point of view. One of the main themes is the transfer of geometric knowledge of a polytope to analytic knowledge of its Fourier transform. The Fourier transform preserves all of the information of a polytope, and turns its geometry into analysis. The approach is unique, and streamlines this emerging field by presenting new simple proofs of some basic results of the field.

May 2024 349pp

9781470470333 Paperback €59.00

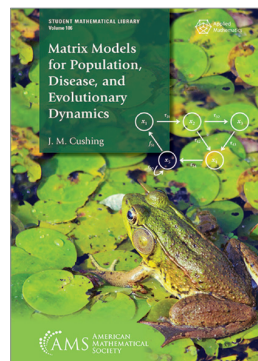

## MATRIX MODELS FOR POPULATION, DISEASE, AND EVOLUTIONARY DYNAMICS

J. M. Cushing

*Student Mathematical Library, Vol. 106*

Offers an introduction to the use of matrix theory and linear algebra in modelling the dynamics of biological populations. Matrix algebra has been used in population biology since the 1940s and continues to play a major role in theoretical and applied dynamics for populations structured by age, body size or weight, disease states, physiological and behavioural characteristics, life cycle stages, or any of many other possible classification schemes. With a focus on matrix models, the book requires only first courses in multivariable calculus and matrix theory or linear algebra as prerequisites.

May 2024 305pp

9781470473341 Paperback €59.00

Order online at [eurospanbookstore.com/ams](https://eurospanbookstore.com/ams)

### CUSTOMER SERVICES

Individual Customers:

Tel: +44 (0)1235 465577

[direct.orders@marston.co.uk](mailto:direct.orders@marston.co.uk)

Trade/Account Customers:

Tel: +44 (0)1235 465576

[trade.orders@marston.co.uk](mailto:trade.orders@marston.co.uk)

### FURTHER INFORMATION

Tel: +44 (0)20 7240 0856

[info@eurospan.co.uk](mailto:info@eurospan.co.uk)

AMS is distributed by EUROSPAN

Prices do not include local taxes.

# New EMS Press title

# ICM

INTERNATIONAL CONGRESS  
OF MATHEMATICIANS  
2022 JULY 6–14

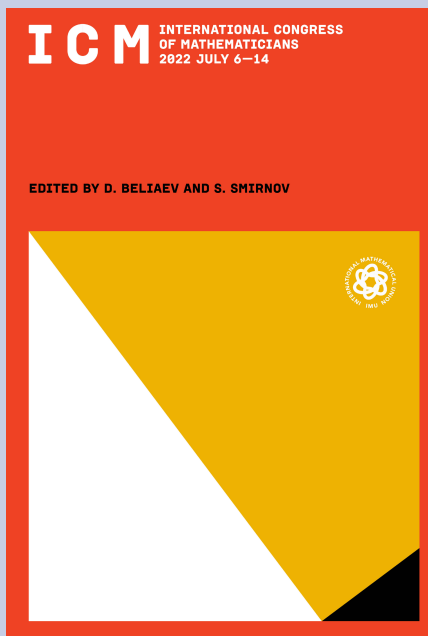

## International Congress of Mathematicians 2022 July 6–14

Edited by  
Dmitry Beliaev (University of Oxford)  
Stanislav Smirnov (Université de Genève)

ISBN 978-3-98547-058-7  
eISBN 978-3-98547-558-2

December 2023  
Hardcover  
5940 pages  
€949.00

Following the long and illustrious tradition of the International Congress of Mathematicians, these proceedings include contributions based on the invited talks that were presented at the Congress in 2022.

Published with the support of the International Mathematical Union and edited by Dmitry Beliaev and Stanislav Smirnov, these seven volumes present the most important developments in all fields of mathematics and its applications in the past four years. In particular, they include laudations and presentations of the 2022 Fields Medal winners and of the other prestigious prizes awarded at the Congress.

The proceedings of the International Congress of Mathematicians provide an authoritative documentation of contemporary research in all branches of mathematics, and are an indispensable part of every mathematical library.

*The contents of the ICM 2022 Proceedings are available online with open access.*

EMS Press is an imprint of the European Mathematical Society – EMS – Publishing  
House GmbH | Straße des 17. Juni 136 | 10623 Berlin, Germany | <https://ems.press>

